



KONICA MINOLTA

LASER IMAGER

# DRYPRO

MODEL 793



The essentials of imaging

Embracing image-based diagnosis,  
Konica Minolta has once again met the critical demands  
of the medical imaging industry and presents  
its next generation dry imager,  
**DRYPRO 793.**



**DRYPRO**  
MODEL **793**



**Featuring 5-size printing capability and space-saving design.**

Capable of printing 5 film sizes (14×17, 14×14, 11×14, 10×12, 8×10-inch). As well as adaptability to ever more diverse modalities. This versatility satisfies the size needs of CR, CT, MRI, Ultrasound, and mammography all in one imager.

Even with an optional six-tray sorter installed, the DRYPRO 793 boasts a footprint of a mere 0.43m<sup>2</sup>, making it the smallest full-size, multi-modality dry imager available.\*

\*Current as of December 2004.



**Furnished with a wide range of convenient functions.**

A Start Timer function automatically powers and warms up the unit by the time you get into the office. Previous Page printing makes reprinting films quick and easy. Status indicators let you know how much film remains in each tray.

Features not only compact design and high image quality... DRYPRO793 presents a new concept that offers user-friendly design to achieve true ease of operation and security



**Featuring a user-friendly, touch-screen interface.**

**Wide range of options available to meet user requirements.**

One film tray is mounted in the standard configuration with optional second and third trays available. 14-inch (accepts 14×17, 14×14, 11×14-inch), 10-inch (accepts 10×12-inch) and 8-inch (accepts 8×10-inch) trays are available as options, providing flexibility of configuration to meet user needs. Additionally, a 6-channel sorter is offered to facilitate post-print sorting.



**User-friendly operability**

The DRYPRO 793 features a large, color, LCD touch panel. The crisp clear display provides easy reading in many selectable languages. The menus are intuitive and easy to navigate. The DRYPRO 793 also features new screen layouts for displaying film type and size and system status.

**Featuring new animated display**

The DRYPRO 793 provides animated instructions in the event the imager runs out of film or requests some action for the user to take. The step-by-step animation presents procedures in an easy to understand format that facilitates quick resolution. This feature frees the user from the burden of referring to manuals in the course of day-to-day operation and makes the unit easy to use even for an inexperienced operator.

**Even more advanced print management**

DRYPRO 793 is furnished with a Web maintenance function that allows the user to use a PC on the same network to access such information as the device status and print progress via the web browser. This affords the user an added degree of security by enabling access to print progress from modalities at remote locations.

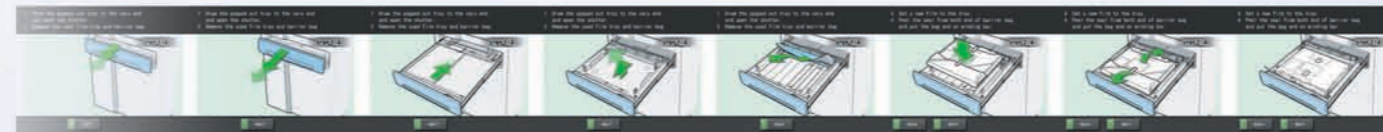

P E R F O R M A N C E

# TECHNOLOGY

The DRYPRO 793 creates images of unrivalled clarity and sharpness by utilizing Konica Minolta's latest precision optics to produce a minimum pixel size of  $25\mu\text{m}$ -the world's highest resolution!

## Full support of the digital mammography

The DRYPRO 793 has received its USA FDA 510k certification as a mammography output device. To ensure stability of mammography image quality, the DRYPRO 793 provides a special mammography QC pattern and an additional roller cleaning mechanism.

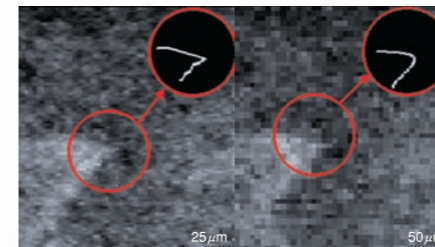

## Furnished with new-generation image processing software.

The DRYPRO 793 utilizes powerful image processing algorithms to simultaneously optimize the smoothness of images and the sharpness of text. Diagnostic clarity is preserved and patient data is always legible, regardless of the size printed.

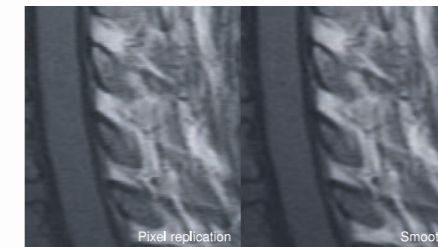

## In relentless pursuit of output image stability.

The DRYPRO 793 utilizes a self-adjusting output density control function. To achieve this, a density patch is measured on every film. Complete grayscale calibration (38 steps) is performed when a new film box is loaded and also when a particular film tray has not been used for a set period of time. This regular calibration process ensures consistent printed densities.

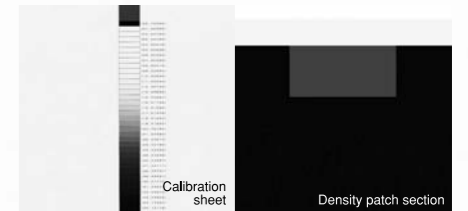

## Defining new standards in image quality!

## In pursuit of high performance

The DRYPRO 793 offers a film printing capacity of 120 sheets per hour for  $14'' \times 17''$  film (90 seconds for the first film), greater throughput for smaller film sizes at standard resolution, and 90 sheets per hour for  $8'' \times 10''$  film in the high resolution,  $25\mu\text{m}$  mode. Additionally, the newly designed film transport assembly handles varied film sizes seamlessly and reliably.

## Heater structure

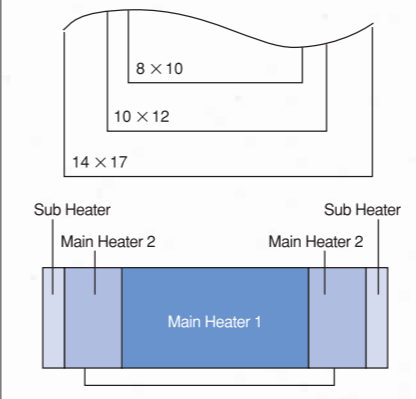

## Newly developed HPRO (heat processing) unit

In order to achieve uniform processing on each film size, the heat processing drum incorporates five internal heaters for image stability during the heat developing process.

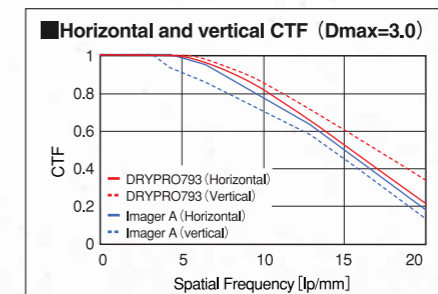
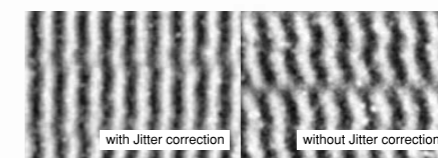

## Equipped with an optical unit to produce the world's highest resolution.

In order to provide the perfect digital mammography solution, it is first necessary to provide functions to accurately record detailed information.

## Medical Imaging Films SD-P

Our daylight dry film is available with a blue base (SD-P) or clear base (SD-PC). Advances in the emulsion and binder material have yielded major improvements in raw film storage and post-processing image stability.

# NETWORK

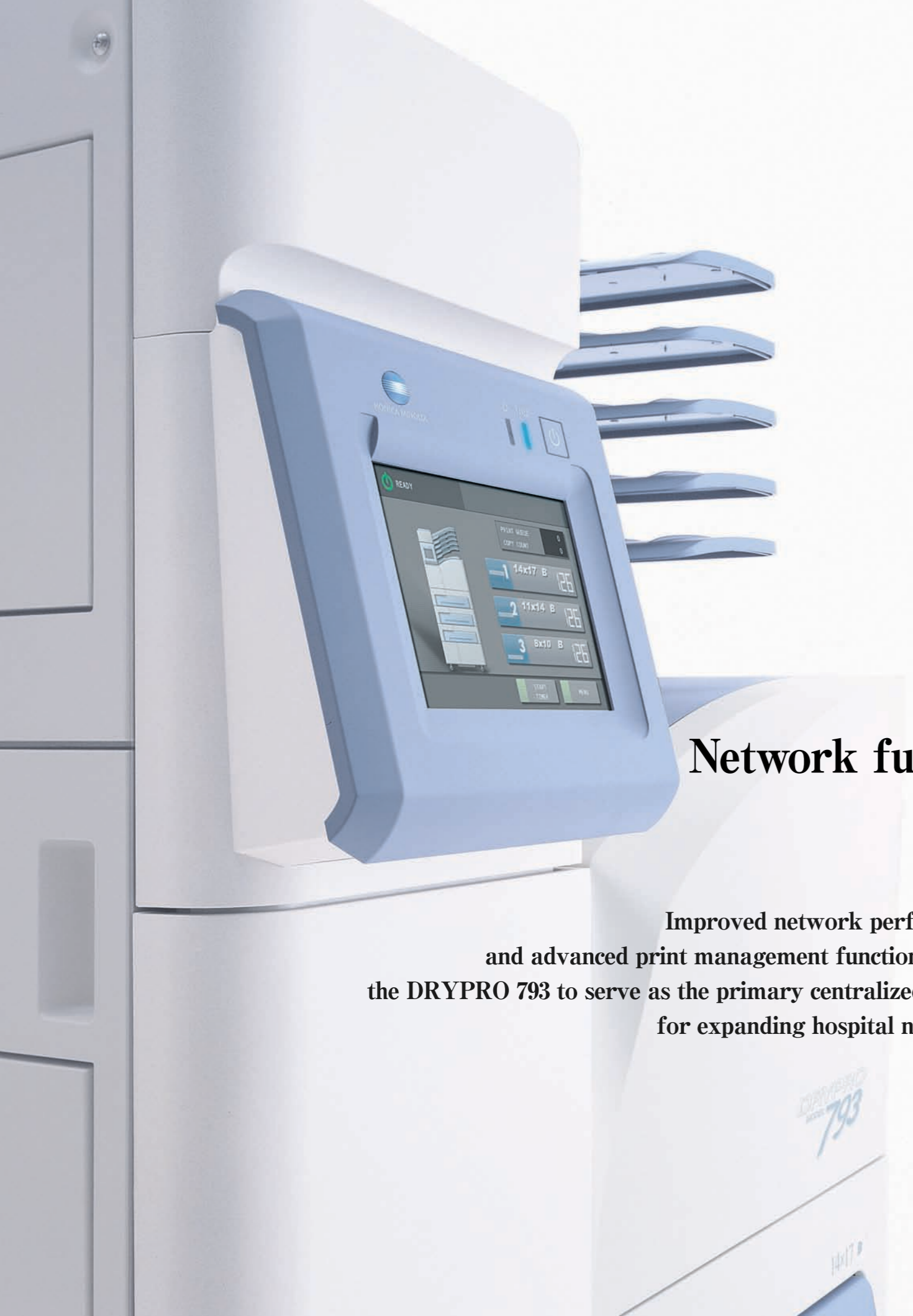

**Improved network performance and advanced print management functions enable the DRYPRO 793 to serve as the primary centralized printer for expanding hospital networks.**

## Direct connection to DICOM network

The DRYPRO 793 is a networked imager capable of connecting directly to DICOM print compliant devices. In addition to DICOM basic grayscale print functions, the DRYPRO 793 supports Presentation LUT (GSDF), which enables printed film to more accurately match diagnostic monitors. Requested Image Size, the DICOM function to ensure true size printing, is also supported.

## Security Support

DRYPRO793 complies with "IHE Basic Security", facilitating maintenance and control of both hospital and patient information.

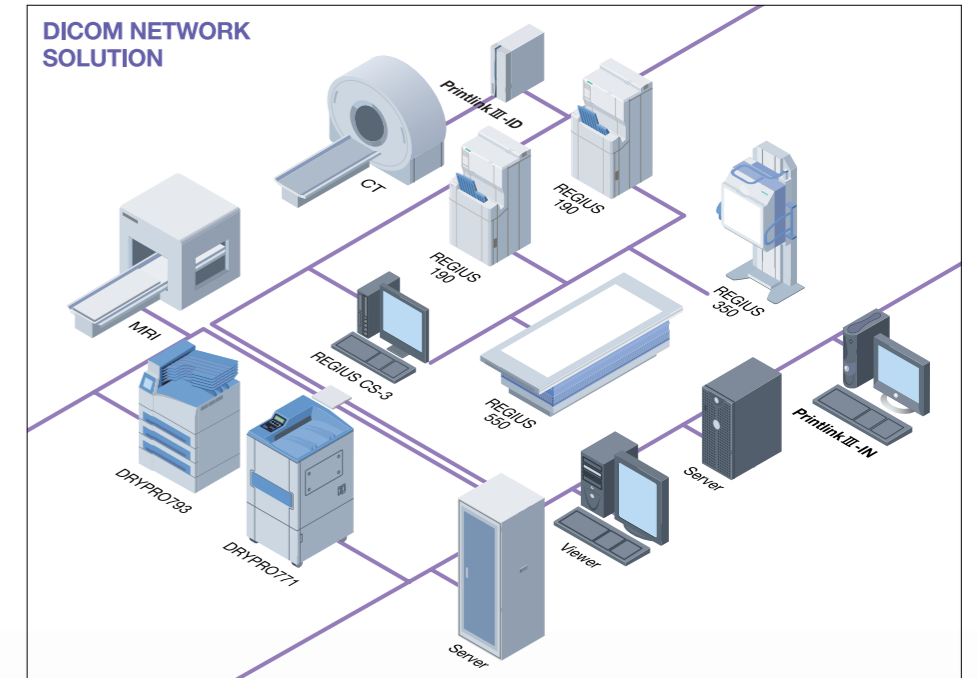

**Network functions designed for open and flexible environments.**

## Unit System Printlink III Series Accommodate Imager Network Environment

The Printlink III print management system can convert image signal (video / digital / network) output from modalities to image data that complies with worldwide standard DICOM 3.0 (Print Management Service Class).

Up to eight units of DICOM-compatible imagers can be connected to one Printlink III unit as output destinations, making back-up system setup simple. With the auto character recognition function (optionally available), patient data such as name, ID, etc. can be added to image data from each modality that does not support DICOM, and transferred to DICOM servers and viewers in DICOM 3.0 (Storage Service Class) form.

**Printlink III lineup**

Printlink III-IV	Video signal connection
Printlink III-ID	Digital signal connection
Printlink III-IN	Network connection



Printlink III-IV/ID

# S P E C I F I C A T I O N S

## Specifications of DRYPRO Model 793

Laser Source	Semiconductor laser	Trimmed frame	Available
Film Size	14"×17"(35×43cm), 14"×14"(35×35cm), 10"×12"(25×30cm) and 8"×10"(20×25cm) selectable	Density Correction	Automatic via built-in densitometer
Film	Dry image recording film SD-P/SD-PC	Positive / negative	Available
Image format	1,2,4,6,8,9,12,15,16,20,24,25,30,35,36,42,48,54,56,60,63,64	DICOM functions	Presentaion LUT service class / Requested Image Size
Image memory	Hard disk (80GB / standard), Print memory (512MB / standard)	Noise Level	Printing : 55dB or less standby : 50dB or less
Input Port	16 ports (max.)	Operating condition	15-30°C (59-86F) 30-70% RH (no condensation)
Number of pixels (14"×17")	REGIUS connection : 8079×9752 pixel None REGIUS connection : 7805×9336 pixel	Power	100-120 V AC / 220-240 V AC, 9.0-7.5 A / 4.5-4.0 A
Pixels size	43.75μ (standard) · 25μ (fine) *optimal 1GB memory are required and only available for 11"×14", 10"×12" and 8"×10" films.	Heat generation	Approx.1200kJ / hour (approx. 286kcal / hour)
Image data input	8 bits / 12 bits	Foot Print	0.43m <sup>2</sup>
Output gradation	16384 levels (14 bits)	Dimensions	W675×D640×H1420mm W26.5×D25.1×H55.9 inch
Image mode	Pixel replication / Function interpolation process	Weight	approx. 255kg(561lb) *with 2film trays
Processing capability	Approx. 120 sheets (14"×17") / hour	Applicable	IEC60601-1-2:2001, IEC60601-1:1988, IEC60825:2001
Input interface	Ethernet 10 base-T / 100 base-TX	Accessories	Power Cable, Operation Manual, Cutter (for film loading),
Protocol	DICOM Print Management	Options	Sorter LiS-793, Expanded Print Memory(1GB), Tray Kit (all 14inch, 10inch and 8×10inch), Tray cover, Deodorant Filter, Cleaning sheet
Supply	Max. 3 channels. 14 inch tray is always the 1st tray, 2nd and 3rd trays are selectable (14"×17", 10"×12", and 8"×10").		
Standby function	Start timer / Nighttime standby		
Boarder processing	Black / White		

## Specifications of LiS-793 (optional)

Dimensions	W675×D640×H1543 mm (Mount with DRYPRO793) W26.5×D25.1×60.7 inch (Mount with DRYPRO793)	Film size	5sizes :14"×17"(35×43 cm), 14"×14"(35×35 cm), 11"×14"(28×35 cm), 10"×12"(25×30 cm), and 8"×10"(20×25 cm)
Weight	30kg (13.6lb)	Power	Supplied from DRYPRO 793
Number of bins	6		
Film load capacity	50 sheets (max.) / bin		

\*In order to improve the performance, the specifications above are subject to change without notice.

## Storing and Handling Dry Film

Dry image recording film SD-P/SD-PC does not require a WET process. When storing and handling film, be sure to observe the following.

### 1. Storing and handling unused film

After confirming that film is packaged, store unused film, like ordinary film, in a cool, dark place (recommended temperature: 10 - 23°C (50 - 73°F)) where it will not be affected by radiation. If film is stored in a place where temperature is more than 30°C (86°F) for a long period of time, the quality of the film may change. When storing film in a film stor-

age, it should be stored in a place where temperature is not likely to rise.

### 2. Storing and handling processed film (image)

①As heat-processed-type film is susceptible to high temperature or strong light even after it's processed, it should be stored in a cool, dark place. When storing film for a long period of time, be sure to place it in a film bag and store it in a place where temperature is 25°C (77°F) or below. The rise in density or discoloration may occur more frequently as the temperature rises.

②If the film is stored at a temperature of

40°C (104°F) or higher, this may cause density changes or discoloration even over a short period of storage. Avoid leaving the film in a car in daytime, or using it with a slide projector, etc.

③As the film is susceptible to strong light as well as temperature, avoid exposing it to direct sunlight, or leaving it on a viewing screen for a long time.

④Dry film photos may be uneven in density, as they are affected by alcohol and processing agents. As the film is not susceptible to humidity, dirt on the film can be cleaned off with a cloth moistened with water.

## Outer dimensions

Unit: mm 1/30 scaled

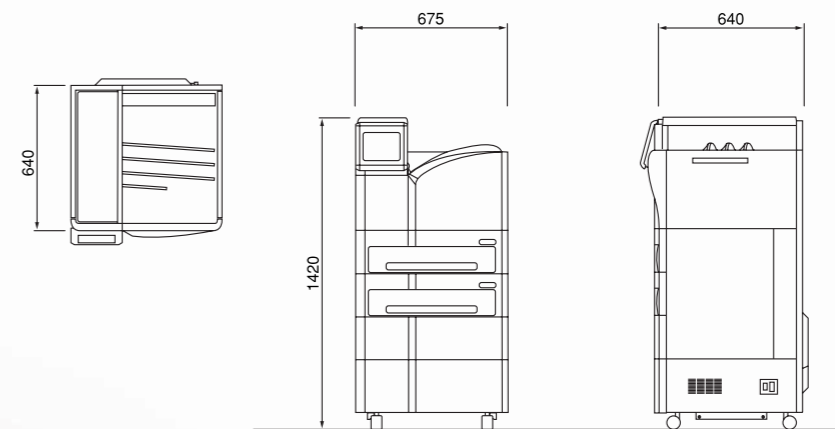

▲DRYPRO MODEL 793 alone

▼DRYPRO MODEL 793+LiS-793 (■area)

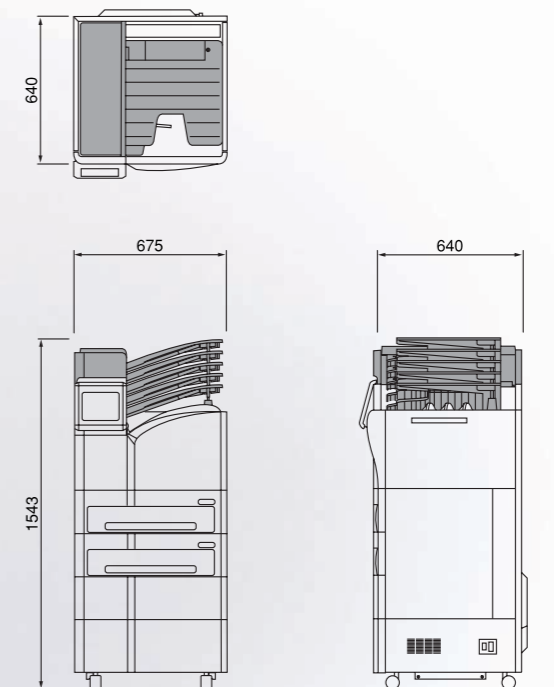



DRYPRO  
MODEL 793



**KONICA MINOLTA**

**KONICA MINOLTA MEDICAL & GRAPHIC, INC.**

No.1, Sakura-machi, Hino-shi, Tokyo, 191-8511, Japan

Distributed by :

---