



KONICA MINOLTA

New Auto Mode increases accuracy at low luminance levels

CHROMA METER CS-200

Suitable for measurement of optical devices such as LCDs, PDPs, organic ELs, FEDs and LEDs.

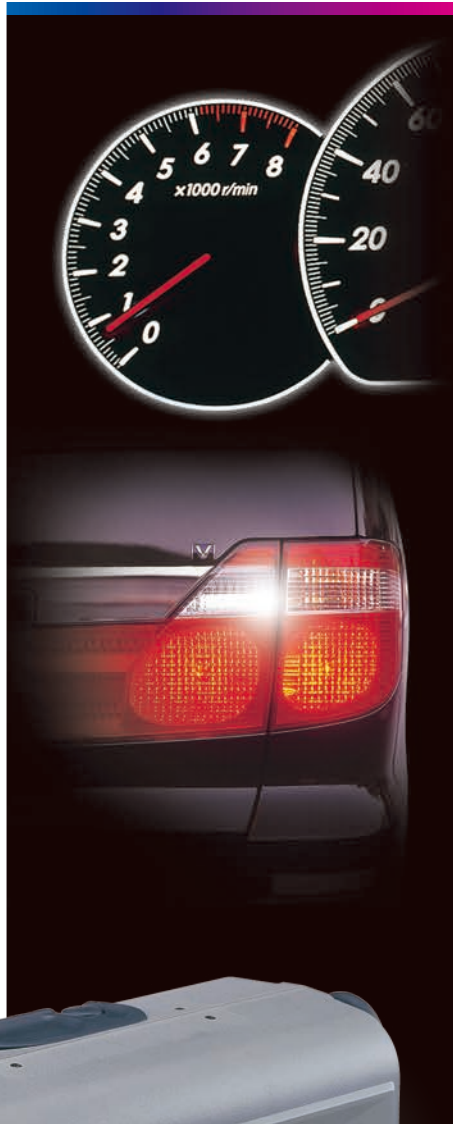
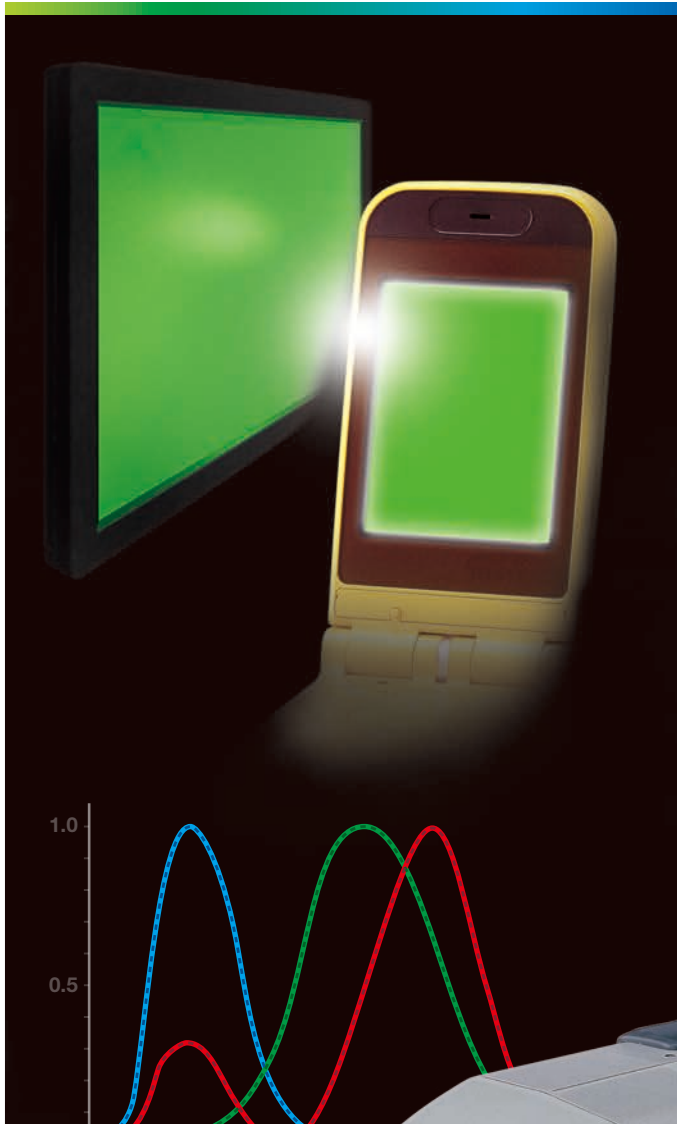

High-Accuracy Luminance & Chromaticity Measurement Comparable to Many Spectroradiometers



Performance Comparable to Many Spectroradiometers Ease of Use and Simplicity Equal to Tristimulus Meters

The technological innovation of displays such as FPDs and LCDs as well as LED products in recent years requires high-quality production, resulting in the need for accurate measuring instruments. The CS-200 is a new type of colorimeter achieving high accuracy while maintaining the simple operation of tristimulus-type colorimeters.

Three selectable angles of 1°, 0.2°, and 0.1° make it easy to measure large and very small objects in a wide measuring range from low luminance of 0.01 cd/m² to high luminance of 20,000,000 cd/m² (with a measuring angle of 0.1°).

The CS-200 can be used for luminance and chromaticity measurement of various optical devices such as displays like LCDs, PDPs, organic ELs and FEDs, as well as light sources such as LEDs and lamps.

New Auto Mode

Wide measuring range from low to high luminance

- The new Auto Mode adjusts the measurement speed according to the luminance of the measurement subject.
- Measurement is available from a low luminance of 0.01 cd/m² to a high luminance of 20,000,000 cd/m² (with a measuring angle of 0.1°).
- Use of the spectral fitting method and precise analog circuitry achieves stable measurement even for low luminance.

Measurement button

Finder and Diopter adjustment ring



Hand strap

Objective lens and Focus adjustment ring



LCD screen

Power switch

Measuring angle selector

USB connector

AC adapter input terminal

Additional Functions

- Measurements can be synchronized with the display device by numerical input of the frequency.
- Selectable measurement speed (AUTO, LTD. AUTO, MANU, superFAST, FAST, SLOW and superSLOW)
- Large LCD display with backlight
- USB 1.1 communication
- Data storage: 101 measured values (9-letter ID assignment possible) and 20 reference values
- User calibration: 20 channels

Accurate measurement

Konica Minolta's newly-developed spectral fitting method enables luminance and chromaticity measurement of single colors in various displays with an accuracy comparable to many spectroradiometers.

Compact and lightweight. Battery power is also possible.

- The compact, lightweight and stylish body allows hand-held operation. The CS-200 can be operated with either four AA batteries (battery indicator function provided) or a special AC adapter.

Selectable measuring angle

- While checking the actual subject, you can select the measuring angle easily according to the application (1°, 0.2° and 0.1°).
- The aperture mirror eliminates misalignment between the finder target and the actual measuring spot, ensuring accurate aiming.

"Spectral fitting method" for accurate luminance & chromaticity measurement.

Konica Minolta's newly-developed spectral fitting method provides tristimulus values (XYZ = red, green, blue) with significantly higher accuracy than that of conventional tristimulus colorimeters. This is achieved by using the output from 40 sensors to calculate the spectral response corresponding to human eye sensitivity (CIE 1931 color-matching functions).

The CS-200 uses 40 sensors for sensitivity covering the entire visible region and multiplies each sensor output by appropriate coefficients. This adjusts the spectral response of the instrument to close to the CIE 1931 color-matching functions.

In addition to the 2° Standard Observer, the 10° Standard Observer (for object-color measurements) can also be selected, which is impossible with conventional tristimulus colorimeters.

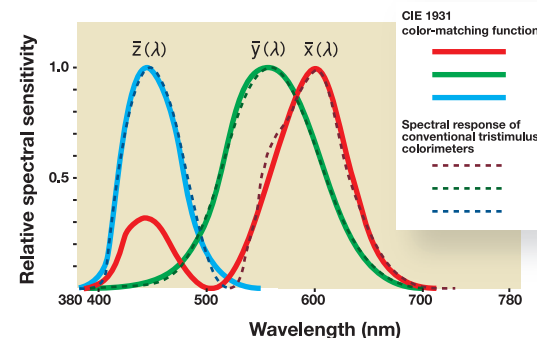

CIE 1931 color-matching functions and spectral response of a conventional tristimulus colorimeter

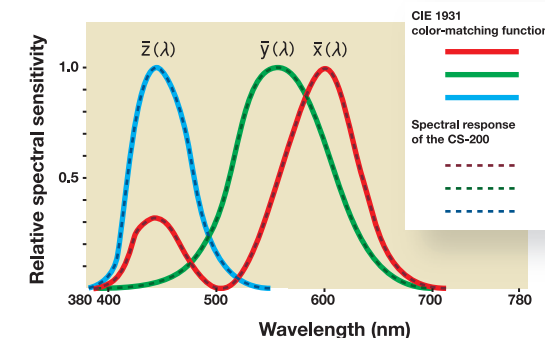

CIE 1931 color-matching functions and spectral response of the CS-200

KONICA MINOLTA's Chroma Meter for accurate light-source measurement allows building of a color management network both internally and externally.

In R&D and design departments

There is no need for calibration work to determine a value of each light source by using a reference spectroradiometer. For displays like LCDs or organic ELs in particular, user calibration for the reference panel using a spectroradiometer can be eliminated *1.

*1 If higher accuracy is required, user calibration can be used.

In quality management and incoming inspection departments

Since individual errors are minimized compared to conventional tristimulus colorimeters, the inspection of various devices such as panels does not require individual error correction.

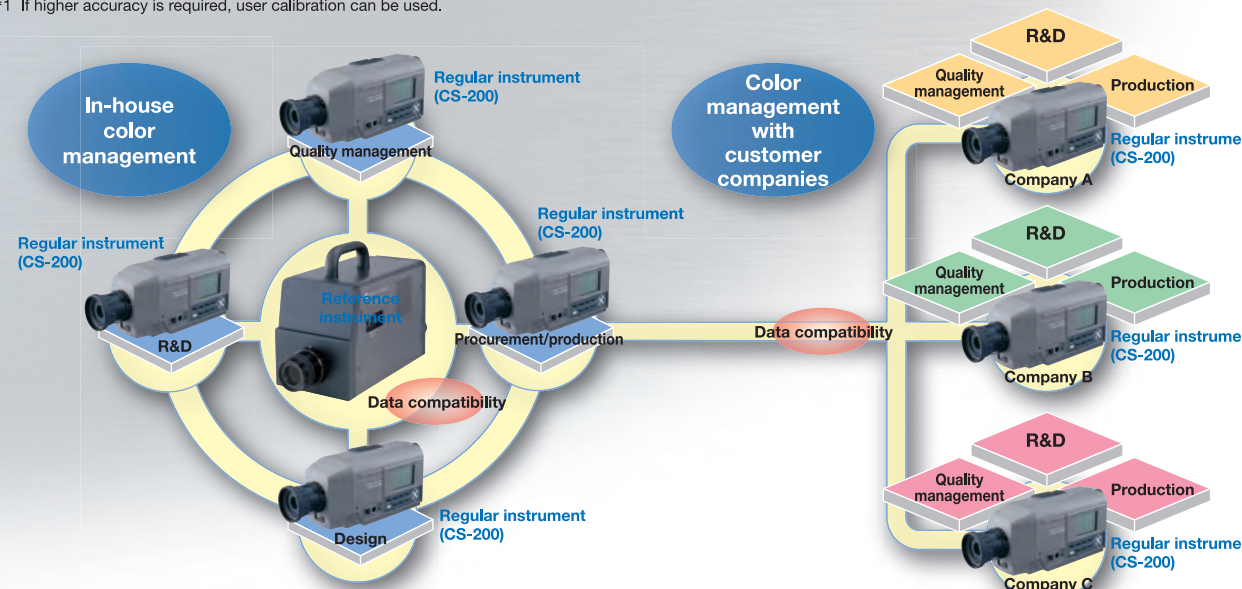



1° aperture

For measurement of general-size areas such as medium and large displays

- LCD, PDP, or EL display panels
- LCD panels of mobile phones or digital cameras
- Light sources such as lamps or fluorescent-tube backlights
- Radar or other instrument panels in aircraft cockpits
- Large outdoor display screens

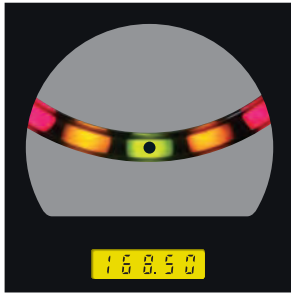

0.2° aperture

For measurement of small areas such as product LEDs

- Sub-display of mobile phones
- Car audio equipment
- Automobile instrument panels

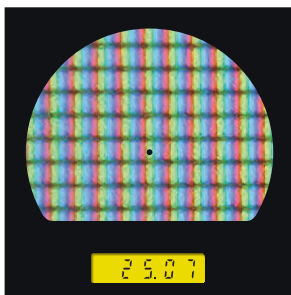

0.1° aperture

For measurement of very small areas or of a distant light source

- Pixels of a PDP or LCD
- Cold cathode tube
- Automobile lamps
- Signal lights



Evaluation applications

- Evaluation of the luminance and chromaticity of light sources
- Evaluation of luminance and chromaticity uniformity
- Contrast evaluation
- γ-characteristic evaluation
- Simple measurement of object colors
- (The optional white calibration plate is required.)



Measuring distance and measuring area

(Unit: mm)

(Measuring angle)	Minimum measuring area			Maximum measuring area			Minimum measuring distance			Maximum measuring distance			Measuring area at 500 mm			Measuring area at 1000 mm		
	1°	0.2°	0.1°	1°	0.2°	0.1°	1°	0.2°	0.1°	1°	0.2°	0.1°	1°	0.2°	0.1°	1°	0.2°	0.1°
Without a Close-Up Lens	φ 4.7	φ 1.0	φ 0.5	∞	∞	∞	296			∞			φ 8.5	φ 1.7	φ 0.9	φ 17.7	φ 3.6	φ 1.8
Close-up lens No. 122	φ 2.2	φ 0.5	φ 0.3	φ 4.6	φ 1.0	φ 0.5	128			240			—	—	—	—	—	—
Close-up lens No. 107	φ 0.8	φ 0.2	φ 0.1	φ 1.1	φ 0.3	φ 0.2	43			52			—	—	—	—	—	—

Measuring distance is the distance from the front edge of the metal lens barrel or close-up lens ring.

Data Management Software CS-S10w Standard (Standard accessory)

CS-S10w Standard Edition allows users to control the CS-200 with a PC to display the list of measured data or to transfer the data to spreadsheet software.

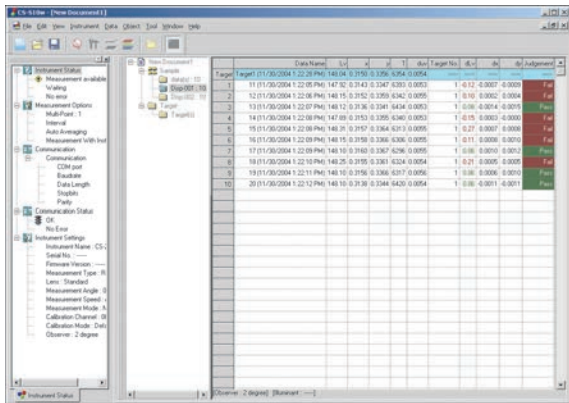

List display

<Functions common to Standard and Professional Editions>

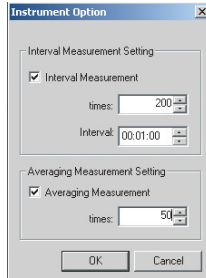

Interval and average measurements

Color space : $L_v x y, L_v u' v', L_v T\Delta uv$
XYZ, dominant wavelength

Mode selection : Normal mode

Object color mode

Instrument control : Average measurement
Interval measurement
User calibration

Data management : Reading and saving files
Data management with folders

Data evaluation : Observer/Illuminant settings
Statistics display for each folder
Box tolerance setting

Data Management Software CS-S10w Professional (Optional accessory)

In addition to the functions of Standard Edition, optional CS-S10w Professional Edition enables various data management, analysis and evaluation functions useful for R&D or quality control.

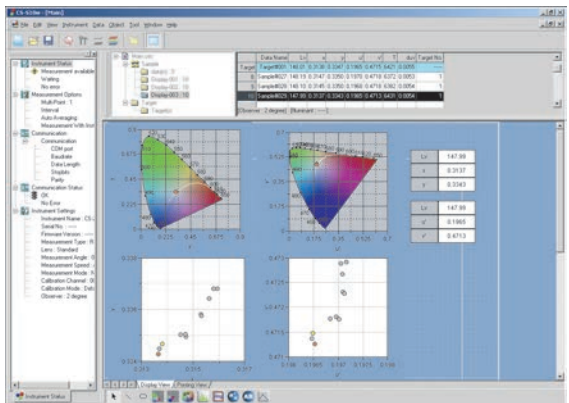

Template showing xy and u'v' chromaticity diagrams

<Functions available only with Professional Edition>

Mode selection : Contrast mode
RGB mode
RGB & contrast mode

Data management : Creating, saving and loading templates (customizable design/layouts for various graphs)
Various graph displays

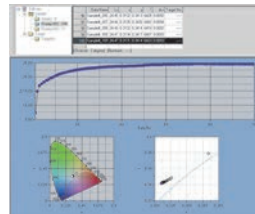

Trend graph display



Multiple-point measurement

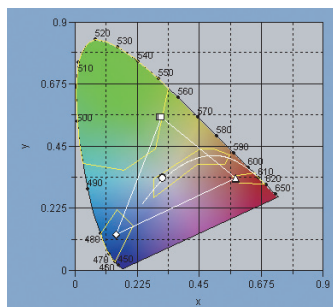

Pass/fail judgment using polygon tolerance (limit values) setting on a chromaticity diagram

Data evaluation : Multiple-point measurement, uniformity display, contrast display and polygon tolerance setting for display evaluation

Other : Creating reports in customizable screen layouts

System requirements (common to Standard and Professional Editions)

	Data Name	L*	a*	b*	T	Δuv	Target No.
Max	148.20	0.3153	0.3381	0.3395			
Min	147.96	0.3143	0.3349	0.3337			
Mean	148.10	0.3146	0.3354	0.3366			
Std.Dev	0.0040	0.00042951	0.00056660	0.00052983			
Non-Uniformity	0.15	0.31	0.39	0.50			
2	Display-001_P02	147.98	0.3143	0.3349	0.3335		0.0054
3	Display-001_P03	148.17	0.3153	0.3361	0.3337		0.0056
4	Display-001_P04	148.20	0.3147	0.3353	0.3363		0.0054
5	Display-001_P05	148.00	0.3145	0.3348	0.3381		0.0053

Uniformity list

OS	Windows® 10 Pro 32-bit, 64-bit Windows® 11 Pro Note: The hardware of the computer system must meet or exceed the greater of the recommended system requirements for the compatible operating system being used or the following specifications.
CPU	Pentium® III 600 MHz or higher
Memory	128 MB (256 MB or more recommended)
Hard disk	At least 60 MB of available storage space.
Display	Display unit capable of showing at least 1024 × 768 pixels / 16-bit color or better
Other	CD-ROM drive (required for installation) One USB port or parallel port (required for the protection key) One USB port Ver. 1.10 or higher (required for connecting CS-200)

• Windows® is a trademark of Microsoft Corporation in the USA and other countries.
• Pentium® is a trademark of Intel Corporation in the USA and other countries.

CS-200 specifications

Model	CS-200		
Display range	0.01 - 200,000 cd/m ² (Measuring angle 1°)		
	0.01 - 5,000,000 cd/m ² (Measuring angle 0.2°)		
	0.01 - 20,000,000 cd/m ² (Measuring angle 0.1°)		
Accuracy	150 cd/m ²	$L_v \pm 2\% \pm 1\text{digit}$	$xy \pm 0.002$
(Measuring angle 1°)*1	0.01 to 0.5 cd/m ²	$L_v \pm 0.02\text{ cd/m}^2 \pm 1\text{digit}$	---
(Standard Illuminant A; Temperature: 23 C±2 C, Relative humidity: 65% max.)	0.5 to 1 cd/m ²	$L_v \pm 0.02\text{ cd/m}^2 \pm 1\text{digit}$	$xy \pm 0.007$
	1 to 10 cd/m ²	$L_v \pm 2\% \pm 1\text{digit}$	$xy \pm 0.004$
	10 to 200,000 cd/m ²	$L_v \pm 2\% \pm 1\text{digit}$	$xy \pm 0.003$
	Light source at 5000 cd/m ² + color filter (R, G, B)		$xy \pm 0.006$
Repeatability	0.01 to 1 cd/m ²	$L_v 0.01\text{ cd/m}^2 + 1\text{digit}$	---
(Measuring angle 1°)*2	1 to 2 cd/m ²	$L_v 0.5\% + 1\text{digit}$	$xy 0.002$ (2σ/AUTO)
(Standard Illuminant A)	2 to 4 cd/m ²	$L_v 0.5\% + 1\text{digit}$	$xy 0.001$ (2σ/AUTO)
	4 to 8 cd/m ²	$L_v 0.5\% + 1\text{digit}$	$xy 0.0005$ (2σ/AUTO)
	8 to 200,000 cd/m ²	$L_v 0.1\% + 1\text{digit}$	$xy 0.0004$ (2σ/AUTO)
Measurement time	AUTO (Automatically set between approx. 1s and 60s)		
	LTD.AUTO (Automatically set to approx. 1s or 3s)		
	Super-FAST (approx. 0.5 sec/meas.) FAST (approx. 1 sec/meas.)		
	SLOW (approx. 3 sec/meas.) Super-SLOW (approx. 12 sec/meas.)		
Measurement method	Spectral method, Grating + linear photo diode array		
Measuring angle	1°, 0.2°, 0.1° (selectable)		
Minimum measuring area	φ 0.5 mm		
Minimum measuring distance	φ 0.1 mm (close up lens)		
Observer	2° or 10° Standard Observer		
Color space	L_v x y, L_v u' v', L_v TΔuv, XYZ, dominant wavelength		
Measurement synchronization setting range	Vertical synchronization frequency : 40.00 to 200.00Hz		
Interface	USB 1.1		
Power source	AC Adapter or 4 AA-Size Batteries		
Battery performance	Approx. 3 hours (continuous measurement / Fast mode / AA-size alkaline cells)		
Size (WxHxD)	95 mm x 127 mm x 334 mm		
Weight	1.8 kg (without battery)		
Operation temperature /humidity range	0°C to 40°C, relative humidity 85% or less (at 35°C) with no condensation		
Storage temperature /humidity range	0°C to 45°C, relative humidity 85% or less (at 35°C) with no condensation		

*1 23°C ±2°C $L_v = 0.01\text{--}10\text{ cd/m}^2$, SLOW, average of 30 measurements
 $L_v = 10\text{ cd/m}^2$ and higher, SLOW, average of 10 measurements

*2 At 0.2° measuring angle, the amount of received light is approx. 1/25 of that for 1°. Therefore, the repeatability becomes the same as that for 1° with 25 times lower luminance.
 At 0.1° measuring angle, the amount of received light is approx. 1/100 of that for 1°. Therefore, the repeatability becomes the same as that for 1° with 100 times lower luminance.

System Diagram

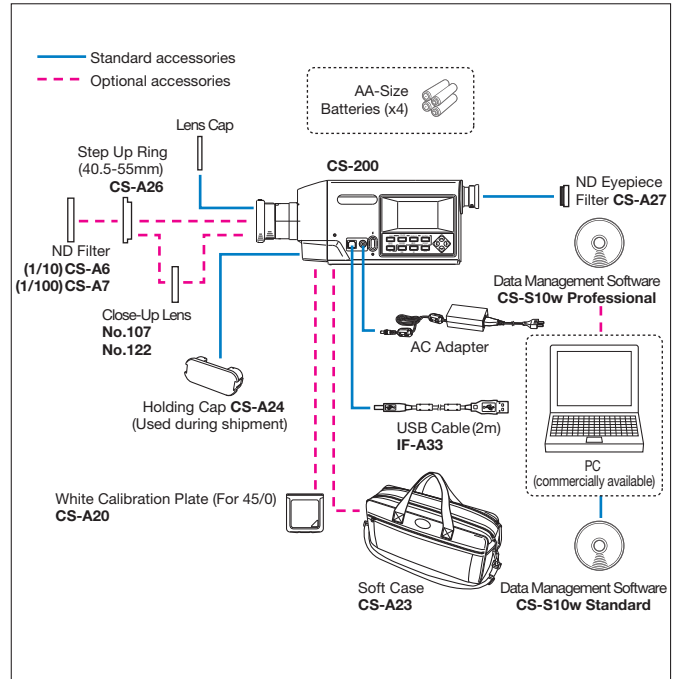

Dimensions (Unit: mm)

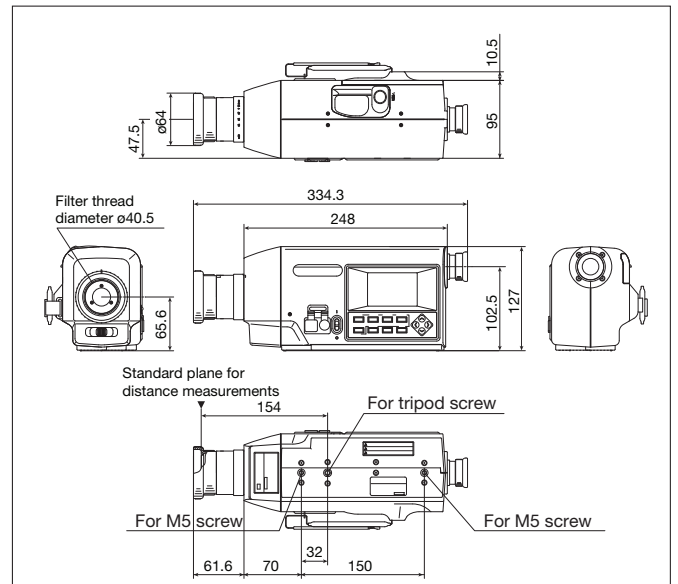

- The specifications and appearance shown herein are subject to change without notice.
- Some lighting control methods may make accurate measurements difficult. For details, please contact your nearest Konica Minolta sales office or dealer.

Customization service:

In order to meet customer needs even more fully, Konica Minolta offers a customization service for modifying products currently being sold.

Main customization service for CS-200 : Modification for high-speed measurement

Customized products will have specifications (such as accuracy and repeatability) different from those of our normal products. Please ask your nearest Konica Minolta dealer for details.

SAFETY PRECAUTIONS

For correct use and for your safety, be sure to read the instruction manual before using the instrument.

- Always connect the instrument to the specified power supply voltage. Improper connection may cause a fire or electric shock.
- Be sure to use the specified batteries. Using improper batteries may cause a fire or electric shock.

ISO Certifications of KONICA MINOLTA, Inc., Sakai Site



JQA-QMA15888
Design, development, manufacture/
manufacturing management, calibration, and
service of measuring instruments



JQA-E-80027
Design, development,
manufacture, service and sales
of measuring instruments

CONTACT US - Global Network

<https://www.konicaminolta.com/instruments/network/index.html>

