

SPECTROPHOTOMETER CM-3700A-U

INSTRUCTION MANUAL



Before using this instrument,
please read this manual.



KONICA MINOLTA

Safety Symbols

The following symbols are used in this manual or CM-3700A-U to prevent accidents which may occur as a result of incorrect use of the instrument.



Denotes an instruction regarding a safety warning or note.
Read the instruction carefully to ensure safe and correct use.



Denotes an instruction regarding the risk of electric shock.
Read the instruction carefully to ensure safe and correct use.



Denotes an instruction regarding the risk of fire.
Read the instruction carefully to ensure safe and correct use.



Denotes a prohibited action.
This action must never be performed.



Denotes an instruction.
This instruction must be strictly adhered to.



Denotes a prohibited action.
Never disassemble the instrument.



Denotes an instruction.
Be sure to disconnect the AC adapter from the AC outlet.



This symbol indicates A.C.



This symbol indicates D.C.



This symbol indicates class II protection against electric shock.

Trademarks











- Windows® is a registered trademark of Microsoft Corporation in the United States and other countries.







Notes on this Manual

- Copying or reproduction of all or part of the contents of this manual without KONICA MINOLTA's permission is strictly prohibited.
- The contents of this manual are subject to change without prior notice.
- Every effort has been made in the preparation of this manual to ensure the accuracy of its contents. However, should you have any questions or find any errors, please contact your retailer or a KONICA MINOLTA-authorized service facility.
- KONICA MINOLTA will not accept any responsibility for consequences arising from the use of the instrument.

Safety Precautions

To ensure correct use of this instrument, read the following points carefully and adhere to them. After you have read this manual, keep it in a safe place where it can be referred to anytime a question arises.

 WARNING		(Failure to adhere to the following points may result in death or serious injury.)	
 <p>Do not use the instrument in places where flammable or combustible gases (gasoline, etc.) are present. Doing so may cause a fire.</p>		 <p>Do not disassemble or modify the instrument or the AC adapter. Doing so may cause a fire or electric shock.</p>	
 <p>Always use the AC adapter supplied as a standard accessory or the optional AC adapter, and connect it to an AC outlet of the rated voltage and frequency. If an AC adapter other than those specified by KONICA MINOLTA is used, it may result in damage to the unit, fire or electric shock.</p>		 <p>Take special care not to allow liquid or metal objects to enter the instrument. Doing so may cause a fire or electric shock. Should liquid or metal objects enter the instrument, turn the power OFF immediately, disconnect the AC adapter plug from the AC outlet, and contact the nearest Konica Minolta-authorized service facility.</p>	
 <p>If the instrument will not be used for a long time, disconnect the AC adapter plug from the AC outlet. Accumulated dirt or water on the prongs of the AC adapter's plug may cause a fire and should be removed.</p>		 <p>The instrument should not be operated if it is damaged or the AC adapter is damaged, or if smoke or odd smells occur. Doing so may cause a fire. In such situations, turn the power OFF immediately, disconnect the AC adapter plug from the AC outlet and contact the nearest Konica Minolta-authorized service facility.</p>	
 <p>Do not forcibly bend, twist, or pull the AC adapter power cable. Do not scratch or alter the power cable or place heavy objects on it. Doing so may damage the power cable and cause a fire or electric shock.</p>		 <p>Always hold the plug itself when disconnecting the AC adapter plug from the AC outlet. Pulling on the power cable may damage it and cause a fire or electric shock.</p>	
 <p>Insert the power plug fully and securely. Incomplete inserting may cause fire or electric shock.</p>		 <p>Do not insert or disconnect the AC adapter plug from an AC outlet with wet hands. Doing so may cause electric shock.</p>	

 CAUTION		(Failing to adhere to the following points may result in injury or damage to the instrument or other property.)	
 <p>Do not perform measurement with the specimen measuring port directed towards your eyes. Doing so may damage your eyes.</p>		 <p>Do not place the instrument on an unstable or sloping surface. Doing so may result in its falling or overturning, causing injury. Be careful not to drop the instrument when carrying it.</p>	
 <p>Be careful not to get your hand caught in the openable section of the instrument. Doing so may result in injury.</p>		 <p>Make sure that the AC outlet is located near the instrument and that the AC adapter plug can be connected to and disconnected from the AC outlet easily.</p>	
		 <p>When cleaning, disconnect the power plug. Connecting may cause electric shock.</p>	

INTRODUCTION

This spectrophotometer is designed for spectral measurement of color and color differences in various industries. It can measure reflected color with high accuracy.

■ Packing Materials

General Packing Materials

Keep all packing materials (cardboard box, cushioning material, plastic bags, etc.) in a safe place. The CM-3700A-U is a precision measuring instrument. They can be used to protect the instrument from impact and vibration during shipment to Konica Minolta for maintenance. Should they be lost or damaged, contact the nearest Konica Minolta-authorized service facility.

Protective cap for the specimen measuring port (integrating sphere opening)

The CM-3700A-U is delivered with no target mask attached. To protect the specimen measuring port, a protective cap is attached to the specimen measuring port. This protective cap must be removed before using the CM-3700A-U. When you transport the CM-3700A-U to another place, the protective cap must be attached. Keep the protective cap in a safe place after putting it in the accessory case (CM-A156).

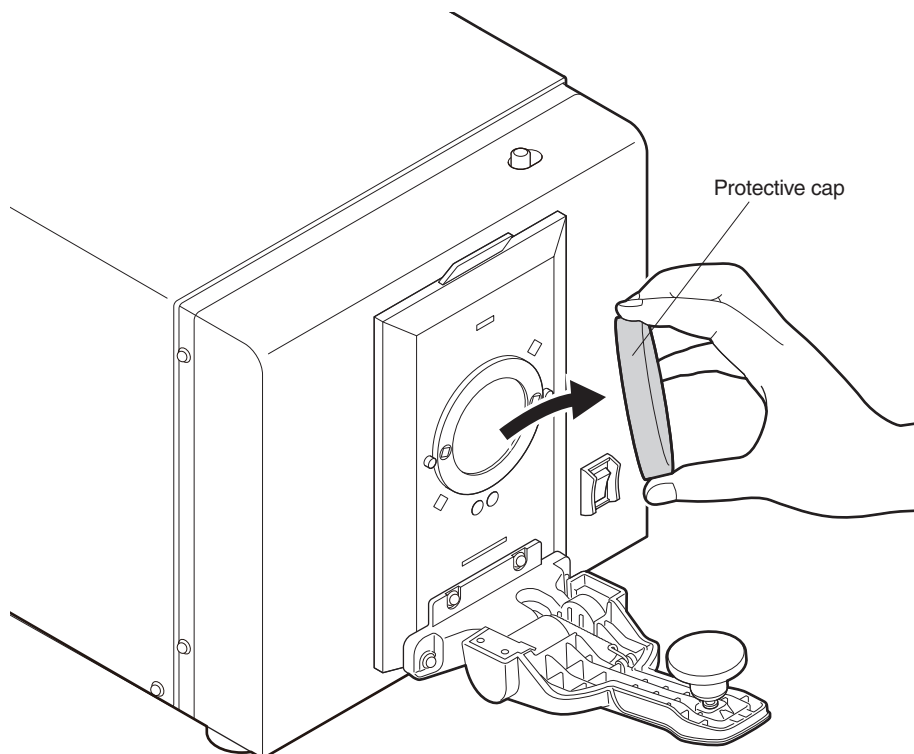

■ Notes on Use

Be sure to use this instrument properly. Use of this instrument in ways other than those specified in this manual may result in risk of injury, electric shock, instrument damage, or other problems.

Operating Environment

- Use the CM-3700A-U at an ambient temperature between 13°C and 33°C and relative humidity 80% or less (at 33°C) with no condensation. Be sure to use the instrument within this range. Do not use it in areas of rapid temperature changes.
- Do not leave the CM-3700A-U in direct sunlight or near sources of heat, such as stoves, etc. The internal temperature of the instrument may become much higher than the ambient temperature in such cases.
- Do not use the CM-3700A-U in areas where dust, cigarette smoke or chemical gases are present. Doing so may cause deterioration in performance or a breakdown.
- Do not use the CM-3700A-U near equipment which produces a strong magnetic field (such as speakers, etc.).
- The CM-3700A-U belongs to installation category I products (equipment which is powered by an AC adapter connected to commercially available power).
- The CM-3700A-U belongs to pollution degree 2 products (equipment which may cause temporary electrical hazards due to contamination or condensation or products which are used in such an environment).
- Do not use the CM-3700A-U at altitudes higher than 2,000 m.
- The CM-3700A-U and the AC adapter supplied as a standard accessory have been designed exclusively for indoor use. They should never be used outdoors because rain or other factors may damage the instrument.

Measurement

- Make sure no dirt or dust get into the specimen measuring port.
- When using the instrument for long periods of time, the measurement value may change depending on changes in the environment. Therefore, in order to achieve accurate measurements, we recommend that white calibration be done regularly using the White Calibration Plate.

White Calibration Plate

- The calibration data for the White Calibration Plate was measured at 23°C.
To achieve the highest accuracy when measuring absolute values (colorimetric values), calibration and measurement should be performed at 23°C.
- Do not allow the White Calibration Plate to get scratched or stained with such as fingerprints.
- Do not move the White Calibration Plate while it has been caught by the sample holder. Doing so may damage the White Calibration Plate.
- When the White Calibration Plate is not in use, be sure to close the cover so that the White Calibration Plate is not exposed to ambient light.

Target Mask

- Do not touch the Target Mask's inner surface (white-coated surface) by hand, scratch it or make it dirty.
- When not in use, Target Masks should be stored in the accessory case (CM-A156) so that they will not be exposed to ambient light.

Power Source

- Make sure that the power switch is set to OFF (" I ") when the CM-3700A-U is not in use.
- Always use the AC adapter supplied as a standard accessory (AC-A4075) and connect it to an AC outlet of the rated voltage and frequency.
- Use an AC power supply of the rated supply voltage (within $\pm 10\%$).
- Do not connect the AC adapter to an overloaded electrical circuit. In addition, do not wrap or cover the AC adapter with cloth or other material while in use. Doing so may cause an electric shock or fire.

System

- Do not subject the CM-3700A-U to strong impact or vibration. Doing so may cause deterioration of performance or breakdown.
- The specimen measuring port and integrating sphere are extremely precise components, and great care should be taken to prevent them getting dirty or exposing them to impacts. When the CM-3700A-U is not in use, be sure to attach a target mask to the measuring port to prevent entry of foreign matter.
- The CM-3700A-U may cause interference if used near a television, radio, etc.
- This instrument complies with Electrical equipment for measurement, control and laboratory use - EMC (Electromagnetic Compatibility) requirements - Part 1: General requirements (EU Harmonized Standards EN 61326-1:2021). Conformity verification is performed under KONICA MINOLTA's test conditions in an INDUSTRIAL ELECTROMAGNETIC ENVIRONMENT specified in the relevant harmonized standards. The limit of performance degradation when subjected to continuous disturbance during immunity testing is up to 4 times KONICA MINOLTA's repeatability specifications (ΔE^*ab).
- Since the CM-3700A-U uses a microcomputer, external magnetic noise may cause malfunction. In this case, turn the power OFF, and wait 30 minutes, and then turn it ON again.

■ Notes on Storage

- The CM-3700A-U should be stored at temperatures between 0°C and 40°C, and at a relative humidity of 80% or less (35°C) without condensation. Do not store the instrument in areas subject to high temperatures, high humidity, sudden changes in temperature, or where freezing or condensation may occur, because these circumstances may cause a breakdown. It is recommended to store the CM-3700A-U with a drying agent at a temperature around 20°C.
- Do not leave the CM-3700A-U inside a car such as in the trunk. Otherwise, the temperature and/or humidity may exceed the allowable range for storage during midsummer or midwinter, resulting in a breakdown.
- Keep the packing materials used for shipment and use them to transport the CM-3700A-U. This protects the instrument from sudden changes in temperature, vibration, and shock.
- Do not store the CM-3700A-U in areas where dust, cigarette smoke or chemical gases are present. Doing so may cause deterioration in performance or a breakdown.
- Entry of dust into the specimen measuring port will hinder accurate measurement. When the instrument is not in use, you must attach the target mask and the sample holder, and cover the instrument with the supplied Dust Cover to prevent the entry of dust into the integrating sphere.
- The White Calibration Plate may become discolored if left exposed to light. Therefore, make sure to close the cover when it is not in use so that the White Calibration Plate is not exposed to ambient light during storage.
- The Target Masks may discolor if they are left exposed to light. When they are not in use, keep them in a safe place to prevent exposure to light and to protect them from scratches and dust. And store them in the accessory case (CM-A156).
- Take care not to leave the CM-3700A-U for a long period of time with a target mask attached. The sample holder may stick to the target mask.
- Be sure to keep all packing materials (cardboard box, cushioning material, plastic bags, etc.). They can be used to protect the instrument during transportation to the service facility for maintenance (re-calibration etc.).

■ Notes on Cleaning

- If the CM-3700A-U becomes dirty, wipe it with a soft, clean dry cloth. Never use solvents such as thinner or benzene.
- If the White Calibration Plate becomes dirty, wipe it with a soft, clean dry cloth. If dirt is difficult to remove, wipe it off with a cloth dampened with commercially-available lens cleaning solution. Then remove the solution with a cloth dampened with water, and leave the plate to dry.
- If the inner surface (white-coated surface) of the Target Masks, or the inside of the integrating sphere, get dirty, contact a Konica Minolta-authorized service facility.
- Should the CM-3700A-U break down, do not try to disassemble and repair it by yourself. Contact a Konica Minolta-authorized service facility.

■ Disposal Method

- Make sure that the CM-3700A-U and its accessories and packing materials are either disposed of or recycled correctly in accordance with local laws and regulations.

CONTENTS

Safety Precautions	1
INTRODUCTION	2
Packing Materials	2
Notes on Use.....	3
Notes on Storage.....	5
Notes on Cleaning.....	5
Disposal Method.....	5
CONTENTS	6

Using the CM-3700A-U

Standard Accessories	8
Optional Accessories	9
System Diagram	10
Names and Functions of Parts	11
Measurement Procedure	12
Flow of Preparation and Measurement	12
Connecting a Personal Computer	13
Connecting the AC Adapter	14
Turning Power ON and OFF	15
Attaching a Target Mask	16
Notes on Use of Target Mask	16
Calibration	17
Calibration for Reflectance Measurements	17
White calibration data	17
Performing calibration.....	18
Attaching the Zero Calibration Box	19
Notes on Use of Zero Calibration Box	19
Attaching the White Calibration Plate ...20	
Notes on Use of White Calibration Plate	20
Updating White Calibration Data	20
Setting a Specimen	21
Reflectance measurement	21
The sample holder for measuring the reflectance ..	22
About opacity measurements	22
Cleaning the CM-3700A-U and Accessories ..23	
Zero Calibration Box and White Calibration Plate... 23	
Target Mask.....	23
Inside Integrating Sphere	23
Error message	24
TROUBLESHOOTING GUIDE	26

Explanations

Illumination/Viewing System	28
Measuring Reflected Colors	28
Illumination area and Measurement areas29	
Illumination area	29
Measurement area	29
Dimensions	30
Specifications	31



Using the CM-3700A-U

Standard Accessories

White Calibration Plate CM-A154

Used to perform white calibration for measurement of reflectance. A CD-ROM containing white calibration data and software for writing the white calibration data is supplied with this accessory.

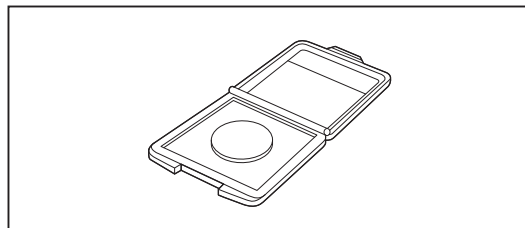

Target Mask CM-A91 CM-A95

Used to change the illumination area (measurement aperture area) according to the specimen. Measurement and illumination (aperture area at specimen surface) areas when each target mask is attached are as follows.

CM-A91 (SAV) : 1 × 3 mm / 5 × 7 mm

CM-A95 (USAV) : 1 × 3 mm / 3 × 5 mm

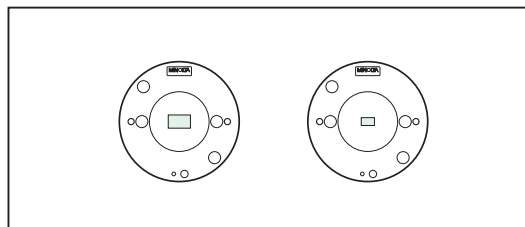

Zero Calibration Box CM-A155

Used to perform zero calibration for measurement of reflectance.

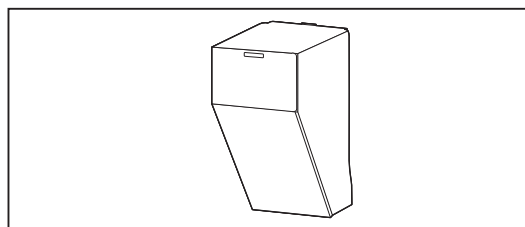

AC Adapter AC-A4075 (ATS018T-A075)

Used to supply power from an AC outlet to the CM-3700A-U.

Input: 100 to 240 V ~ 50-60 Hz 0.48 A MAX

Output: 7.5 V \equiv 2.5 A

Plug design: \oplus \ominus Center-negative

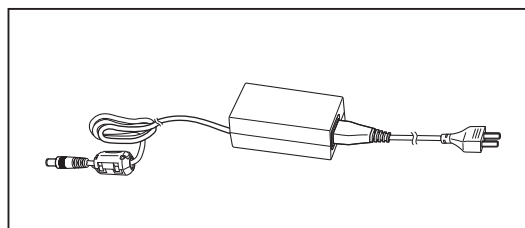

USB Cable (3 m) IF-A21

Used to connect the instrument to a personal computer (PC).

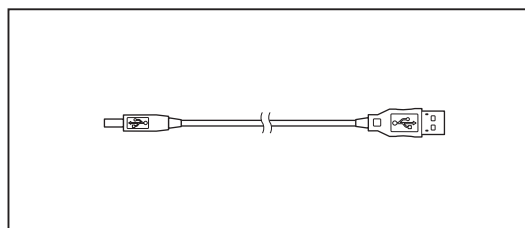

Accessory Case CM-A156

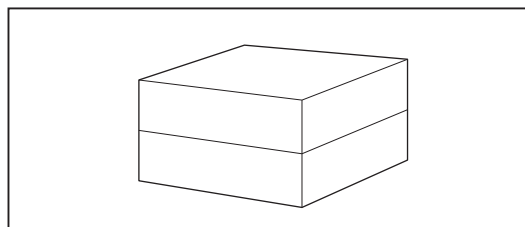

Dust Cover CM-A69

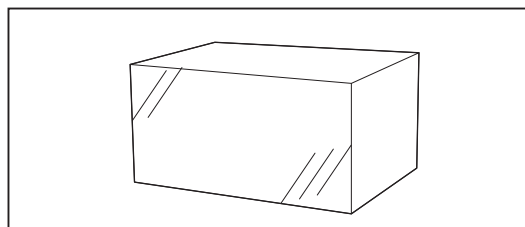

Optional Accessories

Software

SpectraMagic™ NX2

This software provides various functions (e.g., data processing and file management) and allows the user to operate the CM-3700A-U using a personal computer. You can get it on USB memory or download it from <https://www.konicaminolta.com/instruments/download/software/color/smnx2/index.html>



USB Cable (5 m) IF-A22

Used to connect the instrument to a personal computer (PC).

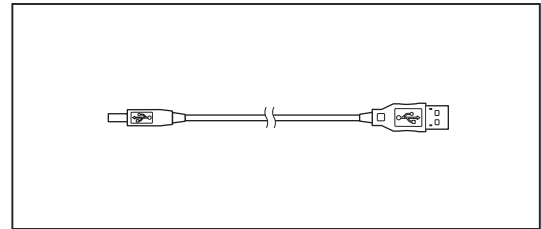

System Diagram

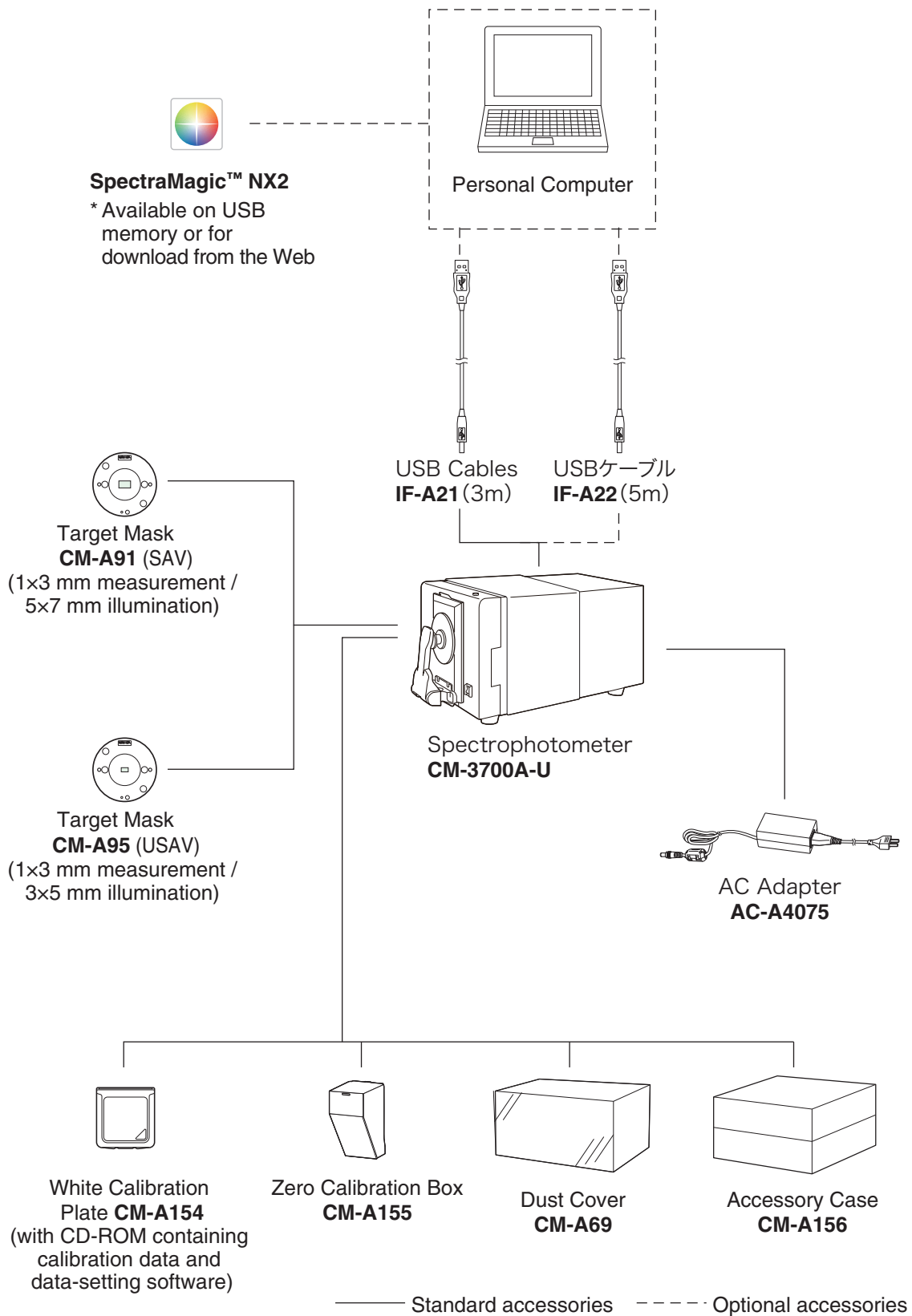

Names and Functions of Parts

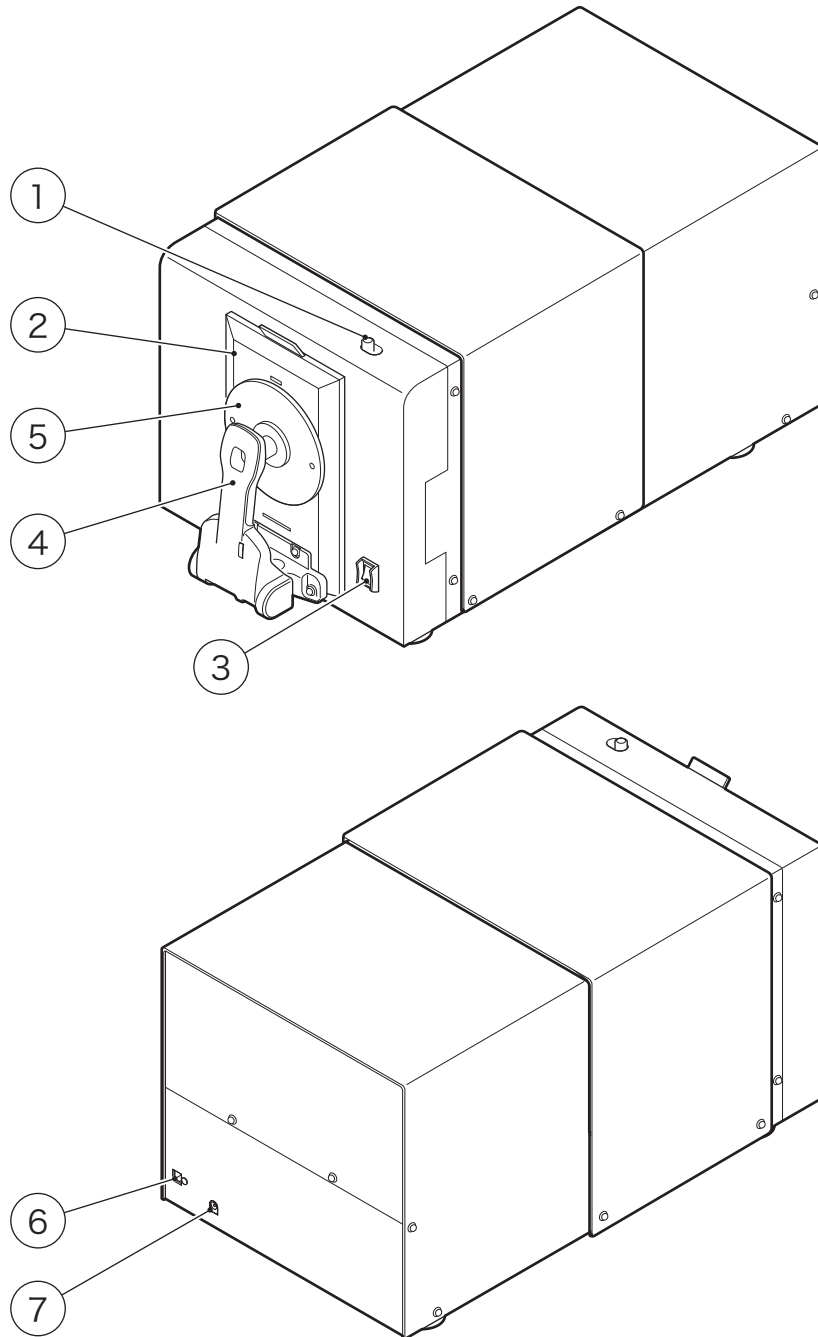

- ① Measurement port baseplate lock..... Used to release the lock of the measurement port base plate.
- ② Measurement port baseplate Can be opened check position of specimen for reflectance measurements.
- ③ Power switch Used to turn power ON and OFF.
- ④ Sample holder Used to hold the specimen, white calibration plate or zero calibration box.
- ⑤ Target mask..... Select a suitable target mask (for 3×5 mm illumination (USAV), 5×7 mm illumination (SAV)) according to the specimen and attach it to the CM-3700A-U.
- ⑥ USB connection terminal Used to connect the instrument to a PC with the supplied USB cable (IF-A21 or IF-A22).
- ⑦ AC adapter input socket..... Used to connect the AC adapter supplied with the CM-3700A-U.

Measurement Procedure

- ¥ This manual explains how to prepare the CM-3700A-U and how to set a specimen.
- ¥ The CM-3700A-U is controlled by a PC to perform measurements.
- ¥ For a description of measuring method using SpectraMagic™ NX2 (optional), refer to the SpectraMagic™ NX2 instruction manual.

■ Flow of Preparation and Measurement

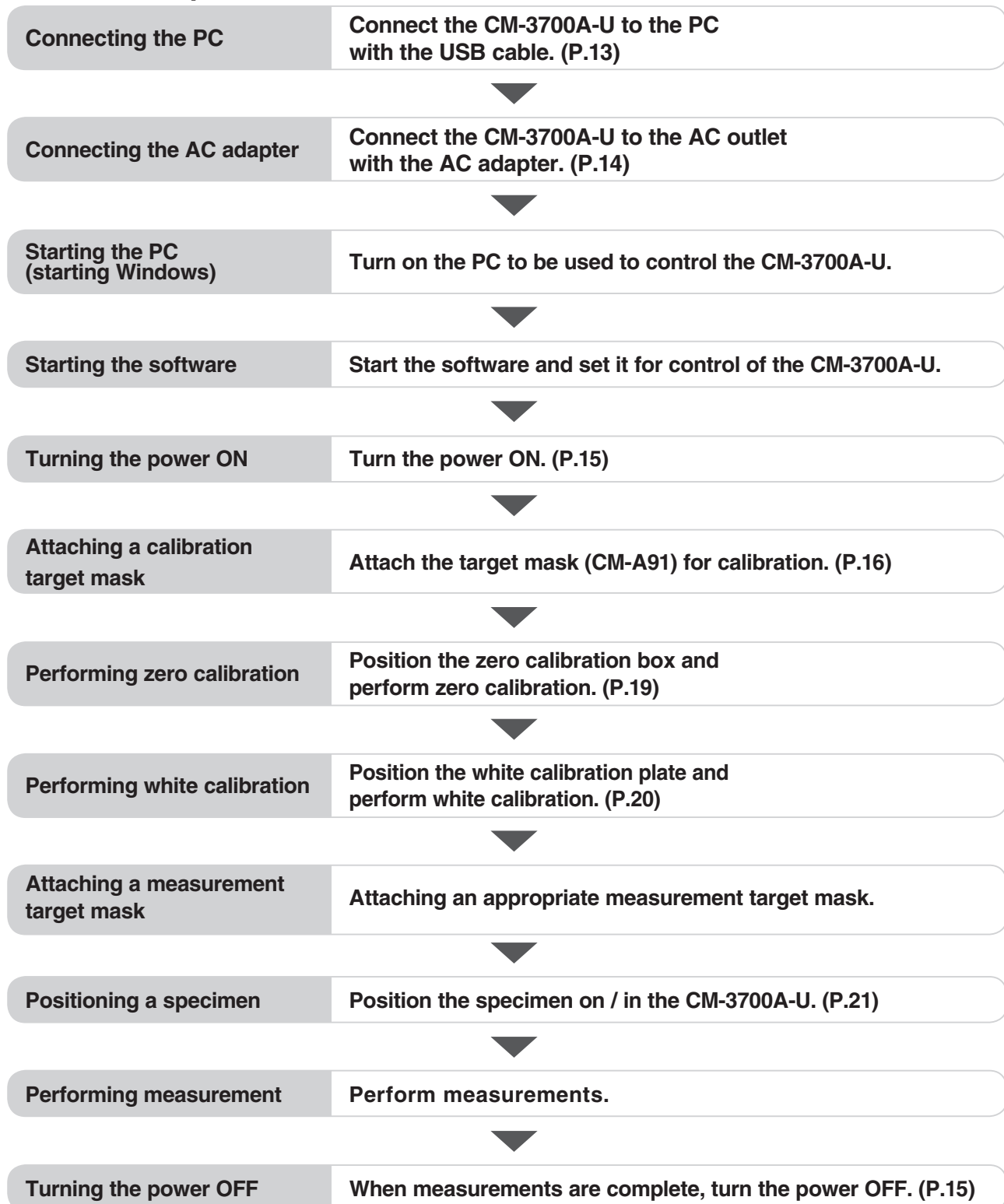

Connecting a Personal Computer

Connect the instrument to a PC with the supplied USB cable IF-A21 (3 m).

- Memo/**
- To connect the instrument with a PC, it is recommended that you use software that enables connection and operation of the instrument (such as the optional Color Management Software SpectraMagic™ NX2).
 - The USB communication port of the instrument conforms to USB 1.1.
- To connect the instrument to a PC, you need to install the USB driver dedicated to the CM-3700A-U. Install the USB driver supplied with the software that enables connection and operation of the instrument.
 - The instrument is not designed to be powered via the USB cable. You need to connect the AC adapter.
 - Make sure that the USB connector plug is oriented correctly and connected securely.
 - When connecting/disconnecting the USB cable, be sure to hold the connector plug. Do not pull on or forcibly bend the cable. Otherwise, wire breakage may result.
 - Make sure that the cable has sufficient length. Putting tension on the cable may cause connection failure or wire breakage.
 - To connect the USB cable connector, check the shape of the receptacle (connection terminal) and insert the connector fully until it is secured.

Operating Procedure

In general, a USB cable can be connected/disconnected while the instrument is turned ON; however, you need to turn OFF the instrument in the procedure below. See P.14 for how to connect the AC adapter and P.15 for how to switch the power on and off.

1. Turn OFF the instrument (Press the “○” side of the Power switch.).

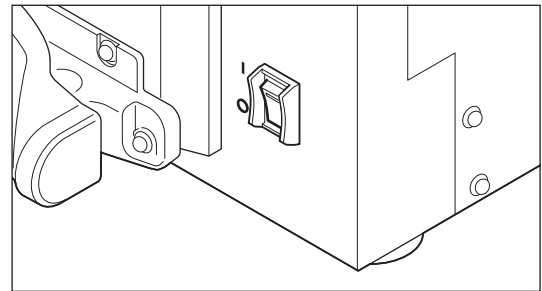

2. Connect the B connector of the USB cable to the USB connection terminal (B type) of the instrument.

- Fully insert the connector and ensure secure connection.

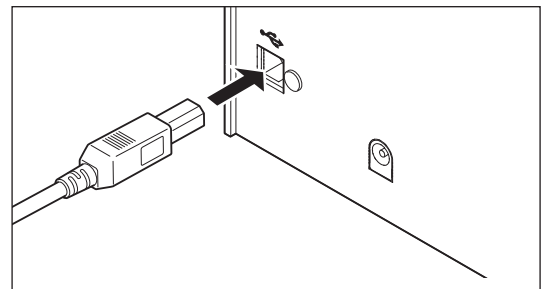

3. Connect the A connector of the USB cable to the USB port of the PC.

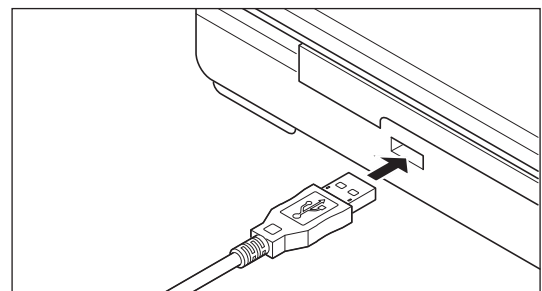

4. Connect the AC adapter and turn ON the instrument (Press the “I” side of the Power switch.).

- When you are prompted to install the USB driver, specify the USB driver included with the software or the white calibration data CD and complete the installation.
- When using the optional Color Management Software SpectraMagic™ NX2, refer to the SpectraMagic™ NX2 Installation Guide.
- After installation of the USB driver has finished, switch the instrument off for a few seconds and then switch it back on.

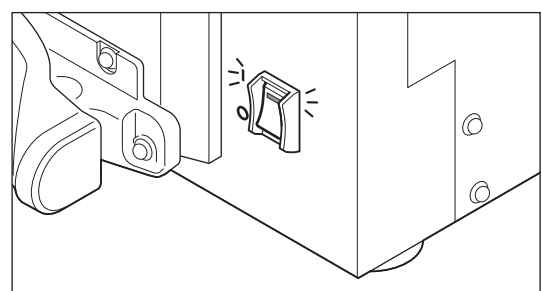

Connecting the AC Adapter



WARNING



Always use the AC adapter supplied as a standard accessory or specified replacement AC adapter with the CM-3700A-U, and connect it to an AC outlet of the rated voltage and frequency. Failure to do so may damage the CM-3700A-U or the AC adapter, causing a fire or electric shock.



If the CM-3700A-U will not be used for a long time, disconnect the AC adapter from the AC outlet. Accumulated dirt or water on the prongs of the AC adapter's plug may cause a fire and should be removed.



Do not insert or disconnect the AC adapter with wet hands. Doing so may cause electric shock.



Insert the power plug fully and securely. Incomplete inserting may cause fire or electric shock.



Do not disassemble or modify the AC adapter. Doing so may cause a fire or electric shock.



Do not unplug or plug in the AC adapter with the instrument's power switch set to ON. Doing so may cause malfunction.

Connecting Procedure

- 1. Make sure that the power switches of both CM-3700A-U and host PC are set to OFF ("○").**

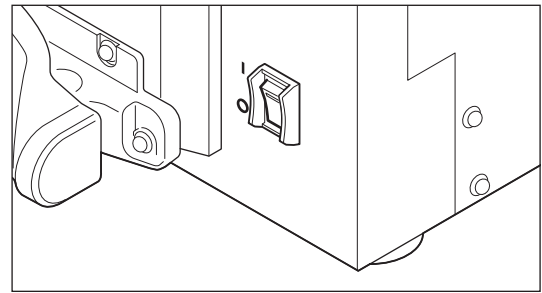

- 2. Insert the output plug of the AC adapter into the AC adapter input socket on the rear of the CM-3700A-U.**

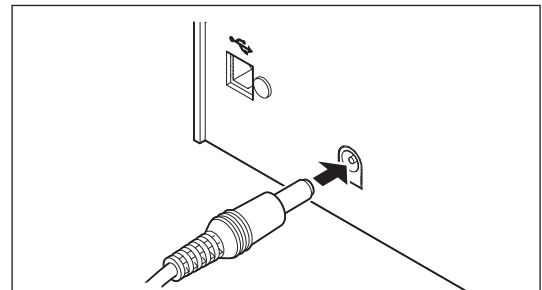

- 3. Insert the input plug of the AC adapter into an AC wall outlet.**

- The AC Adapter AC-A4075 supplied as the standard accessory must be used.
- Before disconnecting the AC adapter, the power switch must be set to OFF ("○").

Turning Power ON and OFF



WARNING



The CM-3700A-U should not be operated if the CM-3700A-U or the AC adapter is damaged, or smoke or strange odors occur. Doing so may result in a fire. In such situations, turn the power OFF immediately, disconnect the AC adapter from the AC outlet, and contact the nearest Konica Minolta-authorized service facility.

Procedure

- 1. To turn the power ON and to light the lamp on the power switch, set the power switch to ON (“ I “).**

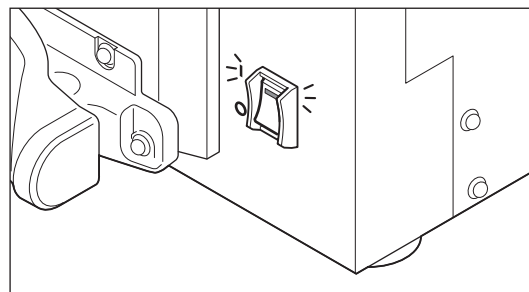

- 2. To turn the power OFF, set the power switch to OFF (“ O “).**

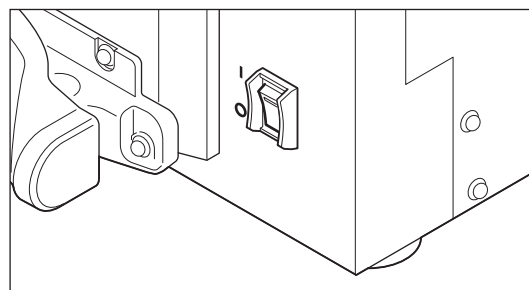

Attaching a Target Mask



WARNING

- Do not place the CM-3700A-U on an unstable or sloping surface. Doing so may result in its falling or overturning, causing injury. Take care not to drop the CM-3700A-U when carrying it.
- Be careful around openings in the CM-3700A-U. Failure to do so may result in fingers being trapped causing injury.

The CM-3700A-U allows you to select a target mask according to the specimen and your application.
SAV target mask CM-A91 (Measurement area: 1 x 3 mm / Illumination area: 5 x 7 mm): for calibration and measurement
USAV target mask CM-A95 (Measurement area: 1 x 3 mm / Illumination area: 3 x 5 mm): for measuring color differences
Be sure to use the SAV target mask CM-A91 for zero calibration or white calibration.

Procedure

1. Pull the sample holder toward you and keep it open.

- The sample holder will remain open when opened more than 70 degrees.

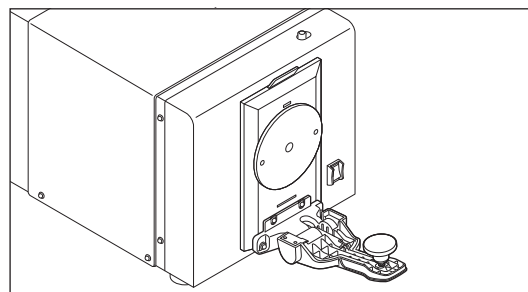

2. Remove the currently attached target mask by pulling it toward you.

- Memo** • The target mask is held on by magnets.

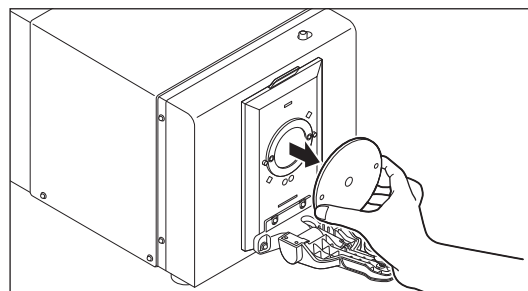

3. Align the target mask positioning holes of the target mask to be attached with the target mask positioning pins of the Spectrophotometer's specimen port baseplate and slide the target mask in against the specimen port baseplate.

- Memo** • The target mask should be attached in the direction that makes the white painted surface face inside (toward the CM-3700A-U side) and position the letters "MADE IN JAPAN" at the top.

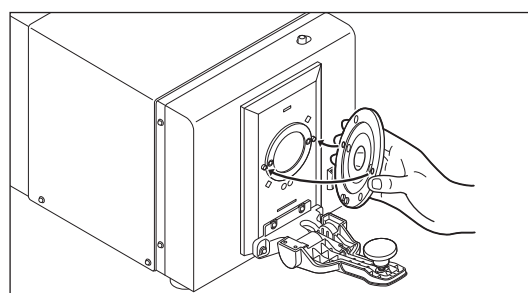

4. Release the sample holder to close it.

■ Notes on Use of Target Mask

- Take care not to scratch or make the inner surface (white-coated surface) of the target masks dirty with such as fingerprints.
- The target masks may become discolored if left in areas exposed to light. Therefore, make sure that target masks which are currently not in use are kept inside the accessory case (CM-A156) to prevent exposure to light.
- When not using the CM-3700A-U, attach one of the target masks or the protective cap to prevent dust entering the integrating sphere.
- Take care not to leave the CM-3700A-U for a long period of time with a target mask attached. The sample holder may stick to the target mask.

Calibration

■ Calibration for Reflectance Measurements

After the Spectrophotometer has been switched on, zero calibration and white calibration must be performed before spectral reflectance measurements are taken. Zero calibration is performed using the Zero Calibration Box (which has a reflectance of 0%) to set the zero reference point for reflectance measurements; white calibration is performed using a white calibration plate (which has a reflectance of approximately 100% and for which spectral reflectance data are provided as white calibration data) to set a high-reflectance reference point for reflectance measurements.

■ White calibration data

The white calibration data of the White Calibration Plate are provided under the following of measurement conditions. When the CM-3700A-U is purchased, these data are already set within the instrument.

- SAV (Measurement area: 1 x 3 mm, Illumination area: 5 x 7 mm) / Specular component : SCI
- SAV (Measurement area: 1 x 3 mm, Illumination area: 5 x 7 mm) / Specular component : SCE

■ Performing calibration



Zero calibration and white calibration is effective only while the Spectrophotometer remains switched on. If it is switched off and then switched on again, both zero calibration and white calibration must be performed before measurements are taken.

- The calibration becomes effective only when being performed under six kinds of measurement conditions. Therefore, for example, when performing the measurement of SCI and SCE alternately, or performing the measurement by switching the measurement area in a sequential order, if you perform zero calibration and white calibration (0% calibration and 100% calibration) in advance as to up to six kinds of necessary measurement conditions, you do not have to perform calibration every time the measurement conditions are changed. However, to more accurately perform measurement, it is recommended to perform zero calibration and white calibration every time measurement conditions are changed.
- When the calibration has been performed under the seventh kind of measurement conditions, the oldest calibration becomes ineffective and the calibration performed under the seventh kind of measurement conditions becomes effective as the latest. Moreover, when the calibration is re-performed under the same measurement conditions as one calibration that was already performed, not that the oldest calibration becomes ineffective, but the calibration already performed under the same measurement conditions becomes ineffective and the re-performed calibration becomes effective as the latest.
- Due to temperature changes in the surrounding environment and heat generation caused by repeated applications, the indicated values may subtly deviate, but if the calibration is regularly performed, the measurement accuracy will improve.

Attaching the Zero Calibration Box



WARNING

-  Do not perform measurement with the specimen measuring port directed towards your face. Doing so may cause damage to your eyes .
-  Be careful around openings in the CM-3700A-U. Failure to do so may result in fingers being trapped causing injury.

The zero calibration box is used to perform zero calibration for measurement of reflectance.

- Before performing zero calibration, attach the target mask (SAV) for calibration.
- Before performing zero calibration, set the same specular component (SCI/SCE) as when performing zero calibration using the software and ensure that UV light condition is set to "100% Full".

Procedure

- 1. Pull the sample holder toward you and keep it open.**

- The sample holder will remain open when opened more than 70 degrees.

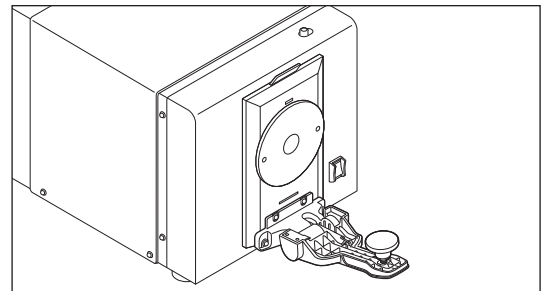

- 2. Fit the projections of the zero calibration box into the grooves on the CM-3700A-U and then close the sample holder to hold the box in place.**

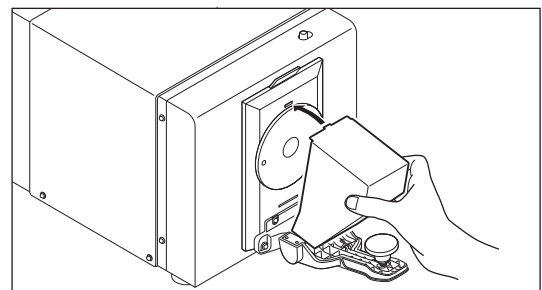



■ Notes on Use of Zero Calibration Box

- Take care not to scratch, touch, or make the inside of the zero calibration box dirty with such as fingerprints.
- If the inside of the zero calibration box gets dirty, wipe it with a soft, clean, dry cloth.
- If dirt is difficult to remove, dampen a cloth with commercially available lens cleaning liquid and wipe the zero calibration box. Then wipe off the liquid with a cloth dampened with water, and leave the box to dry.
- Should the inside of the zero calibration box get so dirty that it cannot be cleaned, replace the box with a new one.

Attaching the White Calibration Plate

CAUTION

-  Do not perform measurement with the specimen measuring port directed towards your face. Doing so may cause damage to your eyes .
-  Be careful around openings in the CM-3700A-U. Failure to do so may result in fingers being trapped causing injury.

The white calibration plate is used to perform white calibration for measurement of reflectance.

- Before performing white calibration, attach the target mask (SAV) for calibration.
- Before performing zero calibration, set the same specular component (SCI/SCE) as when performing zero calibration using the software and ensure that UV light condition is set to "100% Full".

Procedure

1. Pull the sample holder toward you and keep it open.

- The sample holder will remain open when opened more than 70 degrees.

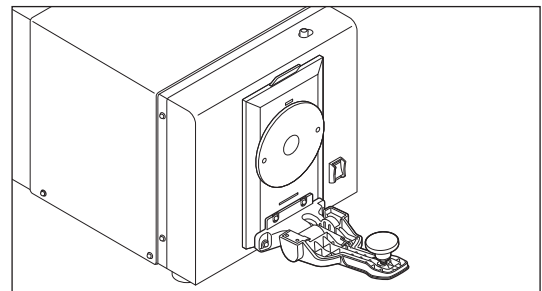

2. Position the white calibration plate so that it is held in place by the sample holder by fitting the sample holder pad into the concave (rear) side of the white calibration plate as shown at right.

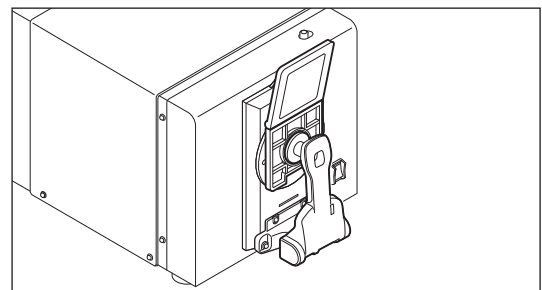

■ Notes on Use of White Calibration Plate

Memo • When performing white calibration, the white calibration data for the white calibration plate being used is required. The white calibration data for the white calibration plate included with the instrument is stored in the instrument's memory at the time of shipment.

- The white calibration plate may become discolored if left exposed to light. Therefore, when not in use, make sure that the lid is closed to prevent exposure to light.
- Take care not to scratch, touch, or make the white calibration plate surface dirty with such as fingerprints.
- If the white calibration plate gets dirty, wipe it with a soft, clean, dry cloth.
- If dirt is difficult to remove, dampen a cloth with commercially available lens cleaning liquid and wipe the white calibration plate. Then wipe off the liquid with a cloth dampened with water, and leave the plate to dry. Should the white calibration plate get so dirty that it cannot be cleaned, replace the plate with a new one. If the White Calibration Plate is changed, reset the white calibration data to the new plate's.

■ Updating White Calibration Data

- You may use the "Data Setting Tool software" stored on the CD-ROM accompanying White Calibration Plate CM-A139 or the optional Color Data Software SpectraMagic™ NX2 to set the white calibration data.

Setting a Specimen



WARNING



Do not use the CM-3700A-U in places where flammable or combustible gases (gasoline fumes, etc.) are present. Doing so may cause a fire.



Do not disassemble or modify the CM-3700A-U. Doing so may cause a fire or electric shock.



The CM-3700A-U should not be operated if it is damaged, or smoke or strange odors occur. Doing so may result in a fire.

In such situations, turn the power OFF immediately, disconnect the AC adapter from the AC outlet, and contact the nearest Konica Minolta-authorized service facility.



CAUTION



Do not perform measurement with the specimen measuring port directed towards your face. Doing so may cause damage to your eyes.



Be careful around openings in the CM-3700A-U. Failure to do so may result in fingers being trapped causing injury.

■ Reflectance measurement

- Before starting reflectance measurements, attach the target mask to be used for measurements.
- Before starting reflectance measurements, set the measurement area and specular component (SCI/SCE) using the software and ensure that UV light condition is set to "100% Full".

Procedure

1. Pull the sample holder toward you and keep it open.

- The sample holder will remain open when it is opened more than 70 degrees.

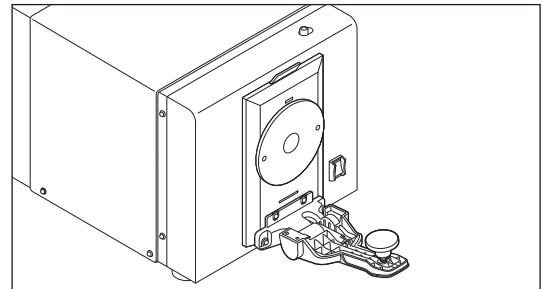

2. Secure the specimen with the sample holder.

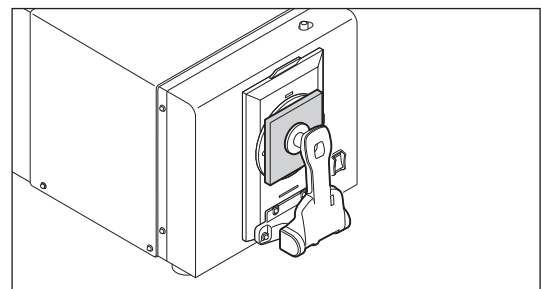

3. Slide the measurement port baseplate lock in the direction of the arrow, open the measurement port baseplate, and check the position of the specimen.

- Hold the measurement port baseplate when sliding the measurement port baseplate lock to keep it from falling open.
- Do not apply strong pressure to the measurement port baseplate when the measurement port baseplate is open.
- The measurement cannot be performed when the measurement port baseplate is open.

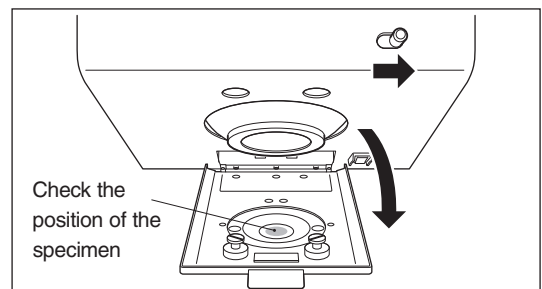

When widely opening the measurement port baseplate

- If you remove the stopper below the measurement port baseplate, the measurement port baseplate can be widely opened.
- Remove the two stopper attaching screws by turning them counterclockwise using a Phillips-head screwdriver.
- Keep the removed screws and stopper in a safe place.
- When widely opening the measurement port baseplate, install the CM-3700A-U at the edge of desk so that the sample holder does not touch the desk below.

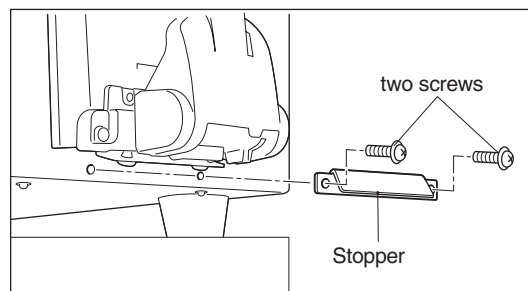

4. Repeat the procedure 2 and 3, and after deciding the position of the specimen so that the part that you want to measure is located at the measurement point, close the measurement port baseplate.

- When shifting the position of the specimen, in order to protect the surface of the specimen, you should pull the sample holder toward the front and keep it open.
- When closing the measurement port baseplate, be sure that the measurement port baseplate lock is at the open position (slid in the direction of the arrow). If the lock is in the closed position, the measurement port baseplate cannot be closed.
- Do not open the measurement port baseplate while performing measurement. Doing so may result in inaccurate measurement.

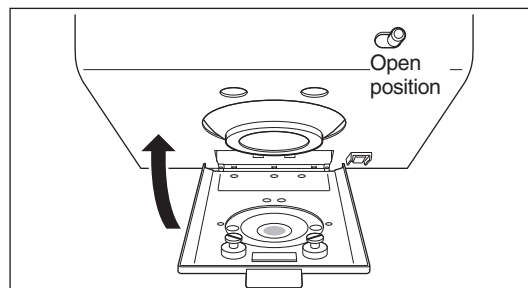

■ The sample holder for measuring the reflectance

To measure the reflectance of a film - or plate-like specimen, the specimen needs to be secured with the sample holder. If the specimen cannot be secured in this way, remove the sample holder and hold the specimen against the measurement aperture.

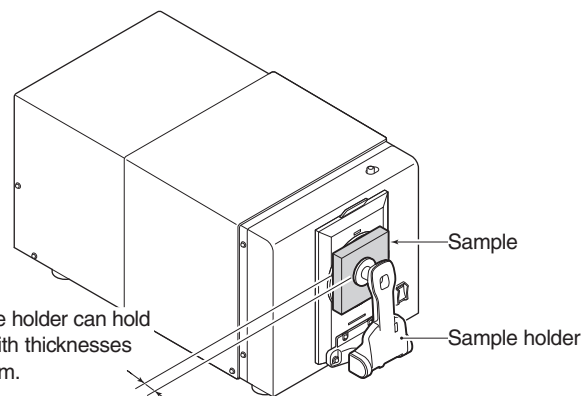

Removing Sample Holder

Procedure

1. To remove the specimen holder when taking reflectance measurements of large specimens, use a crosspoint screwdriver to turn the four screws of the specimen holder counterclockwise, remove the screws, and then remove the specimen holder.

- Keep the screws and sample holder in a safe place.

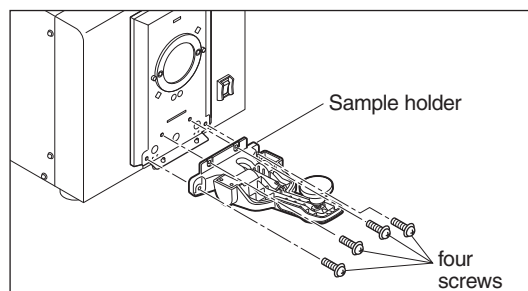

■ About opacity measurements

When using the optional Color Management Software SpectraMagic™ NX2, pairs of white-backed and black-backed measurements can be taken and opacity can be calculated.

Cleaning the CM-3700A-U and Accessories



WARNING



Do not disassemble or modify the CM-3700A-U or AC adapter. Doing so may cause a fire or electric shock.



The CM-3700A-U should not be operated if it is damaged, or if smoke or strange odors occur. Doing so may result in a fire. In such situations, turn the power OFF immediately, disconnect the AC adapter from the AC outlet, and contact the nearest Konica Minolta-authorized service facility.



CAUTION



When cleaning, disconnect the power plug. Connecting may cause electric shock.



Be careful around openings in the CM-3700A-U. Failure to do so may result in fingers being trapped causing injury.

■ Zero Calibration Box and White Calibration Plate

Wipe gently with a dry soft cloth. If dirt is difficult to remove, dampen a cloth with commercially available lens cleaning liquid and wipe. Then wipe off the liquid with a cloth dampened with water, and leave it to dry.

- When cleaning, take care not to scratch the zero calibration box or white calibration plate.

■ Target Mask

Use a blower to remove dirt and dust from the target masks.

- Do not touch the black-coated surface of the target masks with fingers or wipe it with a cloth. If the target masks get so dirty that dirt cannot be removed using a blower, contact the nearest Konica Minolta-authorized service facility.

■ Inside Integrating Sphere

1. Set the specular component to SCI using the software.

2. Open the Measurement port baseplate and remove dust and dirt using a blower.

- Do not touch the white-coated inner surface of the integrating sphere, wipe it with a cloth or place any object against it. If the white-coated surface gets so dirty that dirt cannot be removed using a blower, contact the nearest Konica Minolta-authorized service facility.

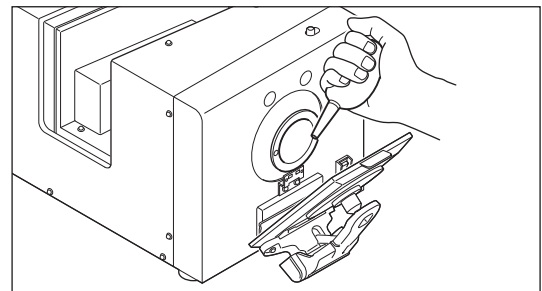

Error message

The following error messages may appear when you use SpectraMagic™ NX2, optional color management software, to control the instrument.

If you see an error message, follow the instructions shown in the table below. If a problem persists, contact the nearest Konica Minolta-authorized service facility.

Error Message	Problem / possible cause	Action	Refer to page
The light intensity of the xenon lamp is decreasing - Degradation of xenon lamps - Contamination of the integrating sphere Contact your nearest authorized Konica Minolta service facility.	The light amount of the xenon lamp has been lowered to 50% or less. • Degradation of the xenon lamp • Contamination of the integrating sphere	Clean the integrating sphere according to the instructions in "Cleaning the CM-3700A-U and Accessories" on page 23. If the problem persists, contact the nearest Konica Minolta-authorized service facility.	23
Flash Error.	The xenon lamp failed to emit light. • Xenon lamp dead • Illumination circuit failure • Sensor failure"	Retry measurement or perform recalibration. If the message persists, contact the nearest Konica Minolta-authorized service facility.	-
Zero calibration or white calibration have not been performed.	Zero calibration or white calibration have not been performed.	Perform zero calibration and white calibration.	19, 20
Zero calibration failed. Make sure the calibration sample is installed correctly and try again.	The zero calibration procedure is not correct.	Perform zero calibration using the provided zero calibration box and appropriate target mask.	16 ~ 18, 19
White calibration failed. Make sure the calibration sample is installed correctly and try again.	The white calibration procedure is not correct.	Perform white calibration using the provided white calibration plate and appropriate target mask.	16 ~ 18, 20
The A/D conversion in the instrument has malfunctioned.	The A/D conversion device installed in the main unit is failed.	Turn the power off and then on again. If the message persists, contact the nearest Konica Minolta-authorized service facility.	15
The attached target mask does not match the current measurement conditions.	Calibration is not possible because the target mask installed is wrong or no target mask is installed.	Install the appropriate target mask and perform the calibration.	16
Failed to measure because the target mask doesn't match the measurement area.	Measurement is not possible because the target mask installed is wrong or no target mask is installed.	Please install the appropriate target mask and perform the measurement.	16
The motor in the instrument has malfunctioned.	The motor for switching between SCI and SCE is not working.	Turn the power off and then on again. If the message persists, contact the nearest Konica Minolta-authorized service facility.	15

Reading or writing the memory in the instrument has failed.	The memory installed in the instrument is not working properly.	Turn the power off and then on again. If the message persists, contact the nearest Konica Minolta-authorized service facility.	15
Flash not ready.	Charging for flashing the xenon lamp is not complete.	Wait for at least 3 seconds after the last flash. If the message persists, contact the nearest Konica Minolta-authorized service facility.	-
Failed to connect to the instrument. Please make sure that the instrument is properly connected to your PC, the selected instrument type is correct, or is not being used by another application.	Communication with the instrument failed. • The power of the instrument is off.	Turn on the power of the instrument.	15
	Communication with the instrument failed. • The cable is not connected properly.	Connect the cable to the computer correctly, then connect the instrument.	13
	Communication with the instrument failed. • It is connected to other applications.	Disconnect from the application you are using and connect to SpectraMagic NX2.	-
	Communication with the instrument failed. • The model name of the selected instrument is incorrect.	Select the correct model name and connect.	-
A long time has passed since last calibration. Please calibrate your instrument.	A certain amount of time has passed since the white calibration.	Perform white calibration again.	20
Annual Calibration is required.	A certain amount of time has passed since the annual calibration.	Contact a KONICA MINOLTA-authorized service facility and request annual calibration.	-
Calibration data is not set.	The calibration data for white calibration is not found.	Load the calibration data into the instrument.	20

TROUBLESHOOTING GUIDE

If a problem occurs with the Spectrophotometer, please check the following points before requesting service. If the problem continues to occur even after the suggested corrective actions have been taken, contact the nearest Konica Minolta-authorized service facility.

Condition	Checkpoint	Recommended action	Refer to page
Reflectance measurement results seem strange.	Was specimen positioned correctly?	Open measurement port baseplate and check measurement point.	21
	Are the white calibration data correct?	Set the correct white calibration data.	20
	Was white calibration performed correctly?	Attach White Calibration Plate correctly and perform white calibration correctly.	20
	Was zero calibration performed correctly?	Attach Zero Calibration Plate correctly and perform zero calibration correctly.	19
Data input/output between the Spectrophotometer and a computer cannot be performed. Commands cannot be input to the Spectrophotometer from a computer.	Is the USB cable connected correctly to both the Spectrophotometer and the computer?	Connect the USB cable correctly between the Spectrophotometer and the computer.	13
	Is the software operating correctly?	By referring to the operation manual of the software, perform the operation correctly.	—
		Set POWER switch of Spectrophotometer to OFF and then set it back to ON.	15



Explanations

Illumination/Viewing System

■ Measuring Reflected Colors

The flow of measurement is shown below.

The geometry of the CM-3700A-U conforms to CIE No.15(2004), ISO 7724/1, ASTM E 1164, DIN 5033 Teil 7, and JIS Z 8722 condition c (diffused illumination/perpendicular viewing system) standards, and offers both $di:8^\circ$ (SCI: specular component included ; Total reflectance) and $de:8^\circ$ (SCE: specular component excluded ; Diffuse reflectance) measurements. (SCI/SCE switchable)

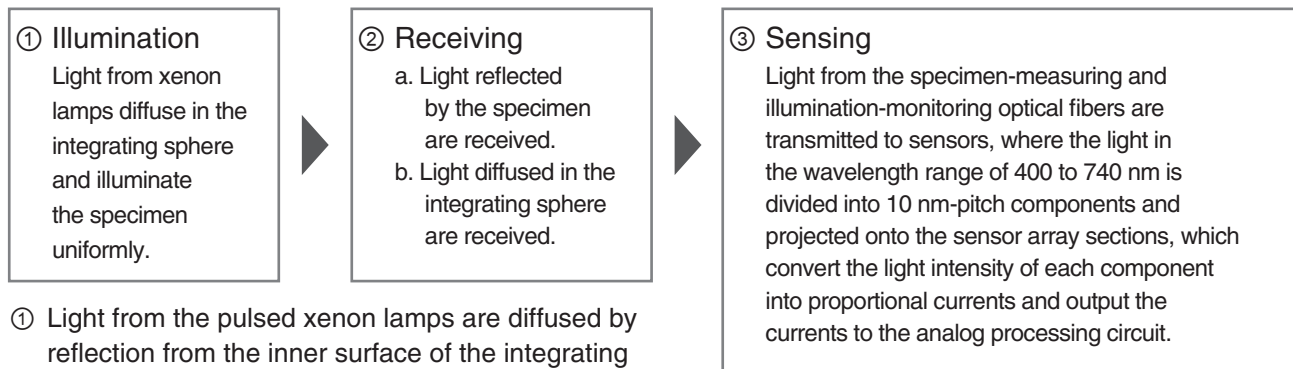

- ① Light from the pulsed xenon lamps are diffused by reflection from the inner surface of the integrating sphere, and finally illuminate the specimen uniformly.
- ②
 - a. The light reflected by the specimen surface at an angle of 8° to the normal to the surface is received by the specimen-measuring optical system and guided to the sensor.
 - b. The diffused light in the integrating chamber is received by the illumination-monitoring optical fiber and guided to the sensor.
- ③ The light from the specimen-measuring optical fiber and from the illumination-monitoring optical fiber is divided into each wavelength component and projected onto the sensor array sections, which convert the light into proportional currents and output the currents to the analog processing circuit.

Memo / • By using the outputs from the specimen-measuring sensor and the illumination-monitoring sensor for calculations, compensation for slight differences in the spectral characteristics and intensity of the illumination light is performed (double-beam system).

Illumination area and Measurement areas

The CM-3700A-U allows you to select an illumination area according to the specimen and your application.

■ Illumination area

The CM-3700A-U allows you to select a SAV target mask (5 x 7 mm) or USAV (for 3 x 5 mm), according to the specimen and your application.

The target mask surface which faces into the integrating sphere has a high-reflectance white coating. Since the reflectance of this coating affects measurements, be careful to protect the white surface from scratches and never touch the white surface.

■ Measurement area

The measurement area is fixed to one kind: 1 x 3 mm measurements.

Dimensions

(mm)

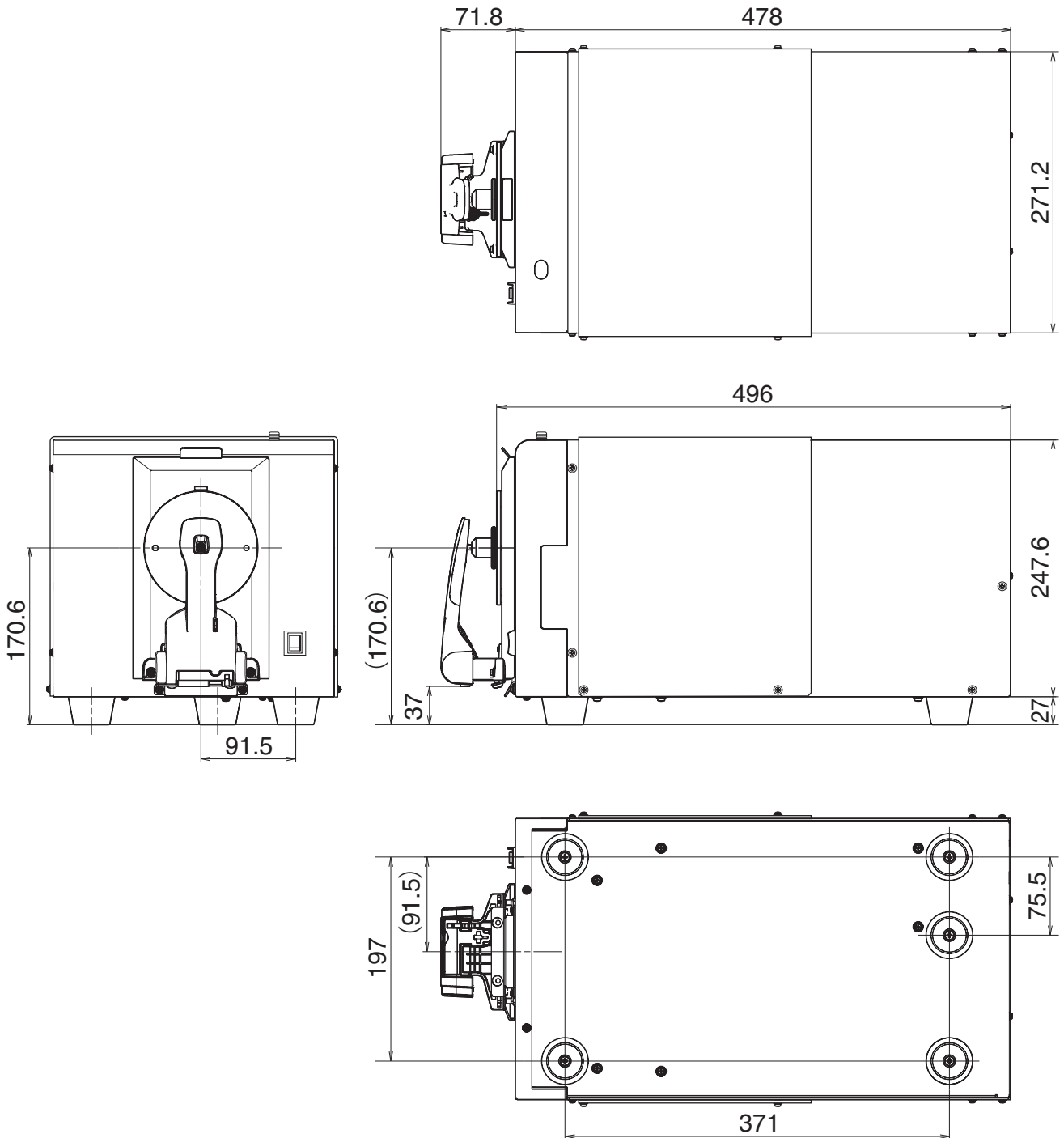

Specifications

Illumination/ viewing system	Reflectance (*1)	di:8°, de:8° (diffuse illumination/8° viewing angle)
		SCI (specular component included)/SCE (specular component excluded) switchable
		Conforms to CIE No.15(2004), ISO 7724/1, ASTM E 1164, DIN 5033 Teil 7 and JIS Z 8722 condition c standard.
Detector	Silicon photodiode array with flat holographic grating	
Spectral separation device	Diffraction grating	
Wavelength range	400 to 740 nm	
Wavelength pitch	10 nm	
Half bandwidth	Approx. 14 nm average	
Measuring range	0 to 200%; Resolution: 0.001%	
Light source	Pulsed xenon arc lamp	
Minimum measurement interval	3 seconds	
Measurement/ illumination area	Reflectance	USAV : 1x3 mm measurement / 3x5 mm illumination
		SAV : 1x3 mm measurement / 5x7 mm illumination
Repeatability(*2)	Spectral reflectance: Standard deviation within 0.05% Colorimetric values: Standard deviation within ΔE^*_{ab} 0.005 (When a white calibration plate is measured 30 times at 10-second intervals after white calibration)	
Inter-instrument agreement (*2)	Within ΔE^*_{ab} 0.2 (Based on average for 12 BCRA Series II color tiles; Compared to values measured with a Konica Minolta master body)	
Interface	USB 1.1	
Power	AC 100 to 240 V 50-60 Hz 25 VA (using included AC adapter)	
Operation temperature/ humidity range	13 to 33°C, relative humidity 80% or less (at 33°C) with no condensation	
Storage temperature/ humidity range	0 to 40°C, relative humidity 80% or less (at 35°C) with no condensation	
Size (W x H x D)	271 x 274 x 500 mm (10-11/16 x 10-3/4 x 19-11/16 in.)	
Weight	Approx. 16.1 kg (35.5 lb.)	

*1 This instrument is designed only for measuring reflected color.

*2 When using Target Mask (SAV) under Konica Minolta standard measurement conditions.

The specifications and appearance shown herein are subject to change without notice.

MEMO

< CAUTION >

KONICA MINOLTA WILL NOT BE LIABLE FOR ANY DAMAGES RESULTING FROM THE MISUSE, MISHANDLING, UNAUTHORIZED MODIFICATION, ETC. OF THIS PRODUCT, OR FOR ANY INDIRECT OR INCIDENTAL DAMAGES (INCLUDING BUT NOT LIMITED TO LOSS OF BUSINESS PROFITS, INTERRUPTION OF BUSINESS, ETC.) DUE TO THE USE OF OR INABILITY TO USE THIS PRODUCT.



KONICA MINOLTA