

COLOR READER

CR-14

OPERATION MANUAL



KONICA MINOLTA

Color Reader CR-14 is an extremely compact, extremely easy-to-use tristimulus colorimeter specifically designed for measuring color and various whiteness or yellowness indexes. After switching on the Color Reader and performing white calibration by placing the tip of the Color Reader against the included white tile and pressing the measuring button, measurements can be taken by simply positioning the Color Reader on the specimen and pressing the measuring button. The Color Reader can be easily operated with one hand and is battery powered for complete portability, and data can be easily sent to a separate printer for printing out.

Please read and study this manual before using the Color Reader for the first time and keep this manual handy for future reference.

- Since the Color Reader CR-14 uses a tungsten lamp as the light source, illumination does not include the UV region. Thus measurements of paper or textiles which include fluorescent materials are not recommended.

CONTENTS

NAMES OF PARTS	2
FUNCTIONS OF CONTROLS	3
POWER	4
Installing Batteries	4
Using AC Adapter	5
DISPLAYS	6
SELECTING DISPLAY MODE	8
WHITE CALIBRATION	9
TAKING MEASUREMENTS	10
PRINTING MEASUREMENT DATA	11
ERROR MESSAGES	13
CAUTION	14
CARE AND STORAGE	14
ACCESSORIES	15
SPECIFICATIONS	16

NAMES OF PARTS

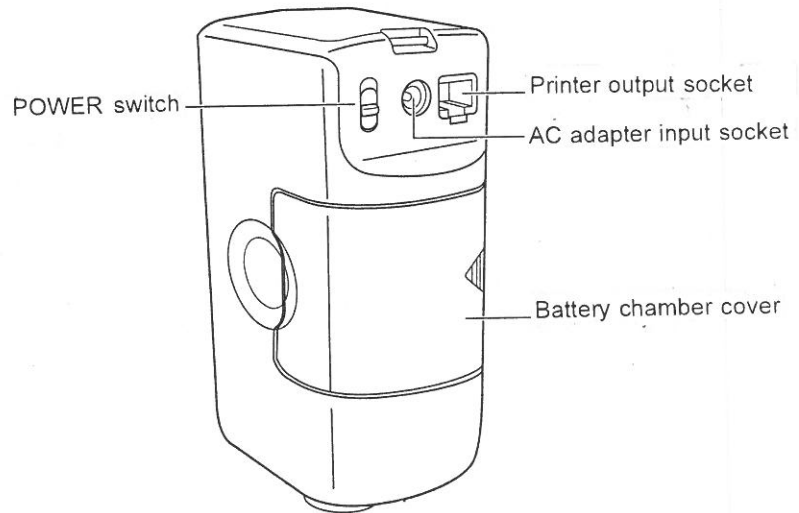
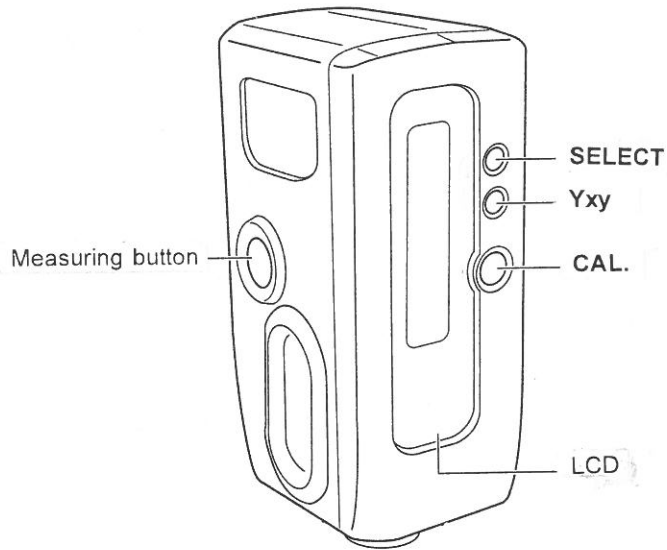

FUNCTIONS OF CONTROLS

Measuring button	Takes measurement.
CAL.	Changes between calibration display and measurement display.
Yxy	Changes between Yxy display and whiteness index display and whiteness index display in CIE display mode.
SELECT	Select display mode.
LCD	Displays measurement results, etc.
POWER switch	Switches power on (I) and off (O).
Battery chamber cover	Covers battery chamber which holds four AA-size batteries.
AC adapter input socket	Used for connecting AC adapter to supply power from an AC socket. Use only AC Adapter AC-A308.
Printer output socket	Used for connecting a printer to print out data.

POWER

The Color Reader can be powered by either four AA-size batteries or optional AC Adapter AC-A308.

Installing Batteries

- When installing or removing batteries, be sure the POWER switch of Color Reader is set to O (off).
- Do not mix battery types or ages. Mixing battery types or ages could result in battery leakage, reduced battery life, or damage to the Color Reader.
- Do not touch or short the battery terminals inside the battery chamber. Doing so may damage the Color Reader.

- 1 Check that the POWER switch is set to O (off) and slide the battery chamber cover in the direction of the arrow while gently pressing it in.

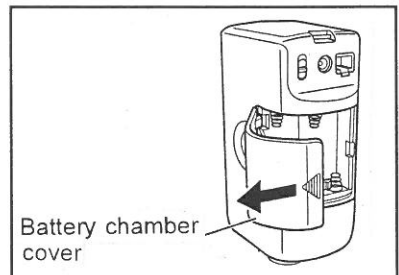

- 2 Install four AA-size batteries in the battery chamber with the polarities as shown inside the chamber.

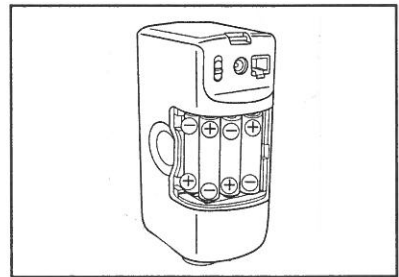

- 3 Close the battery chamber cover.
 - Be sure that both tabs on the battery chamber cover catch.

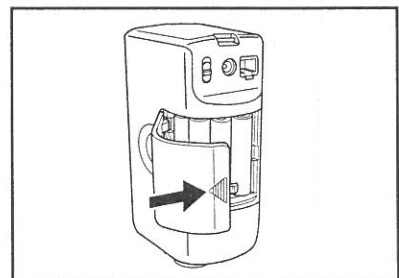

Using AC Adapter

- Use only AC Adapter AC-A308 (available as an optional accessory). Use of other AC adapters may damage the Color Reader.
- When connecting or disconnecting the AC adapter, be sure that the POWER switch of the Color Reader is set to O (off).

- 1 Check that the POWER switch of the Color Reader is set to O (off) and insert the output plug of the AC adapter into the AC adapter input socket of the Color Reader.

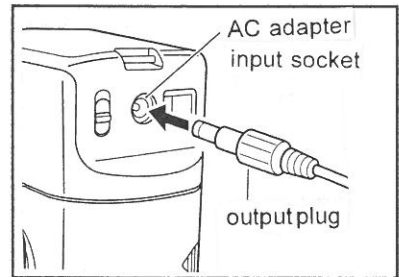

- 2 Insert the input plug of the AC adapter into an AC wall outlet.

DISPLAYS

The Color Reader shows four types of displays.

Mode setting display

The display mode can be selected in this display. There are four display modes: CIE, HUNTER, ASTM D1925 and ASTM E313. Whiteness index measurements are performed in CIE, HUNTER, or ASTM E313 mode. Yellowness index measurements are performed in ASTM D1925 or ASTM E313 mode. The display changes in the following order when **SELECT** is pressed.

Whiteness index

```
Output Select
C I E
```

Whiteness index

```
Output Select
H U N T E R
```

Whiteness index / Yellowness index

```
Output Select
A S T M E 3 1 3
```

Yellowness index

```
Output Select
A S T M D 1 9 2 5
```

Calibration Display

White calibration can be performed in this display.

```
Set Cal. Plate
- - > Measure
```

Initial measurement display

This display appears when the white calibration is finished.

Whiteness index

```
C I E
W           T
```



```
Y
x           y
```

Whiteness index

```
H U N T E R
W
```

Yellowness index

```
A S T M D 1 9 2 5
Y
```

Whiteness index / Yellowness index

```
A S T M E 3 1 3
W           Y
```

Measurement Display

These displays appear when measurements are taken after pressing the measurement button in the initial measurement display.

Whiteness index

C I E			
W	98.5	T	0.01

Tint

Whiteness index



Y	96.4		
x	0.3136	y	0.3301

Whiteness index

H U N T E R	
W	98.2

Whiteness index

Yellowness index

A S T M D 1 9 2 5	
Y—	0.3

Yellowness index

Whiteness index/Yellowness index

A S T M E 3 1 3			
W	99.3	Y—	1.2

Whiteness

Yellowness index

SELECTING DISPLAY MODE

CIE, HUNTER, ASTM D1925, or ASTM E313 display mode can be selected. In CIE mode, Yxy values can also be displayed at CIE mode.

- Display mode can be selected only in the mode setting display. When you want to change the display mode, switch off the power switch for a moment, then switch on again and select the desired display mode in the mode setting display.
- Once display mode is set, it appears when switch on again after you switch off.

1 Set **POWER** switch to | (on). The mode setting display will appear.

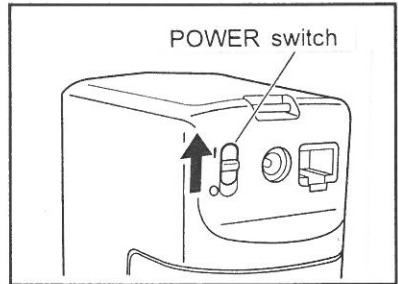

2 Press **SELECT** to select display mode. The display will change when **SELECT** is pressed.

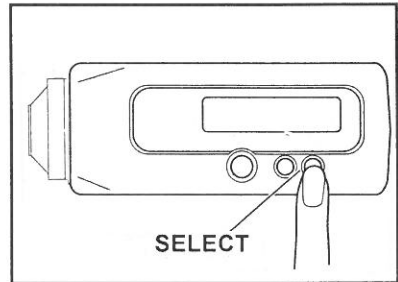
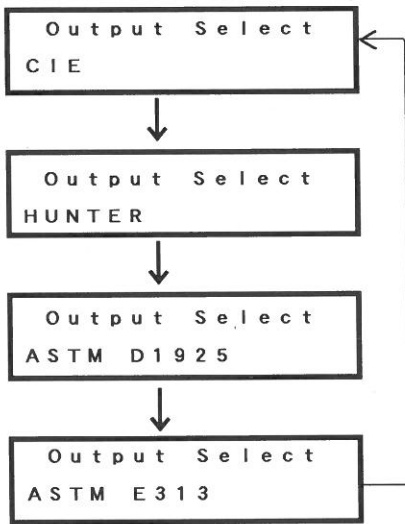

3 Press **CAL.** to set the display mode. The display will change to calibration display.

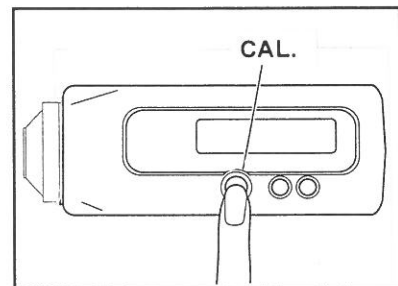

WHITE CALIBRATION

After the POWER switch is set to | (on), white calibration must be performed before measurements can be taken. White calibration can be performed only when the calibration display is shown; this display appears automatically after the POWER switch is set to | (on) and can also be reached from the measurement display by pressing **CAL**.

- Pressing **CAL**, when the calibration display is shown will cause the display to return to the measurement display.

- 1 Set POWER switch to | (on). The mode setting display will appear.

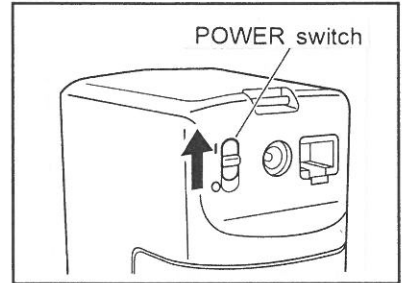

- 2 Set the display mode using SELECT and CAL. The calibration display will appear.

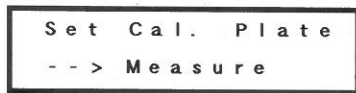

Refer to page 8 for how to set the display mode.

- 3 Place the tip of the Color Reader flat against the white calibration plate.

- Use only the white calibration plate having the same serial number as the Color Reader. Use of a different white calibration plate will result in inaccurate measurements and may also result in error messages.

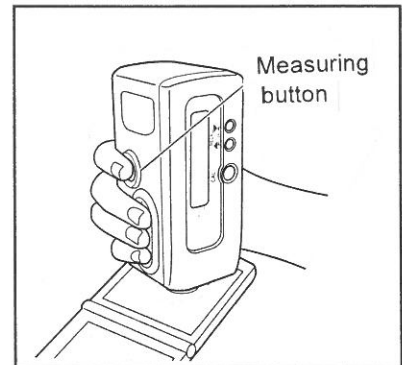

- 4 Press the measuring button. White calibration will be performed and the display will change to the measurement display (showing data if data are stored in memory).



TAKING MEASUREMENTS

- 1 Set the POWER switch of the Color Reader to | (on) and select the display mode. (See page 8)

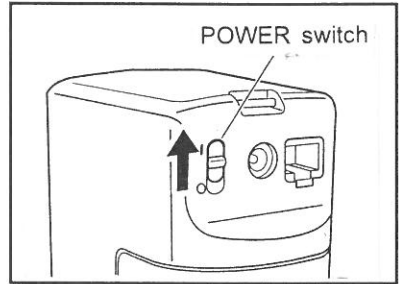

- 2 Perform white calibration. (See previous page).

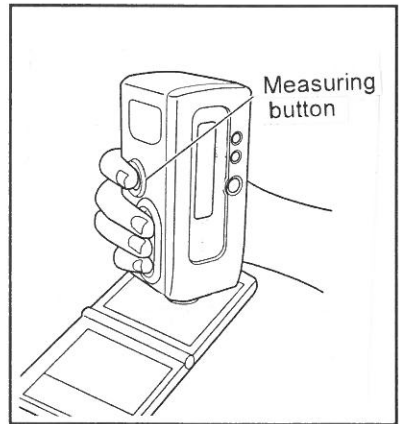

- 3 Place the tip of the Color Reader flat against the color to be measured and press the measuring button. When measurement has been completed, a beep will sound and the measurement results will appear in the display.



- If you want to display Yxy value at CIE, press Yxy key to change the display.

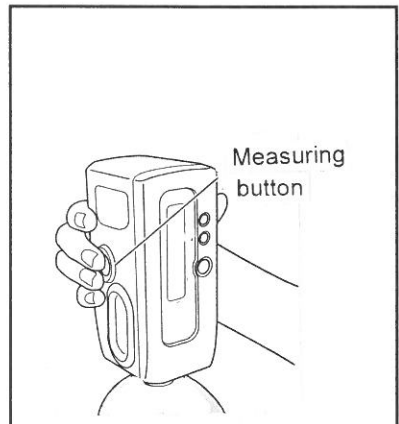
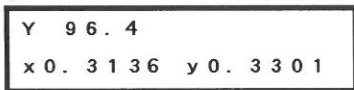

- If the measurement data is over the "range of whiteness" which is regulated as a standard, the values of W and T will be shown as "--" at CIE mode. However the values of W and T at other mode will be calculated regardless of the "range of whiteness".

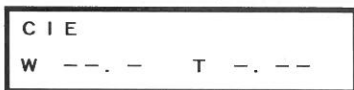

PRINTING MEASUREMENT DATA

By connecting a printer to the Color Reader, measurement data can be printed out at the time of measurement .

Suitable Printers

Printers which have the following specifications can be used with the Color Reader:

Number of printed columns:	At least 27
Data input:	RS-232C standard
Data control:	BUSY
Baud rate:	9600
Character length:	7 bits
Parity:	Even
Number of stop bits:	2 bits
Basic operating codes:	Carriage return CR (0D hexadecimal)

Connections

When connecting a printer, the connections between the Color Reader and the printer should be as follows:

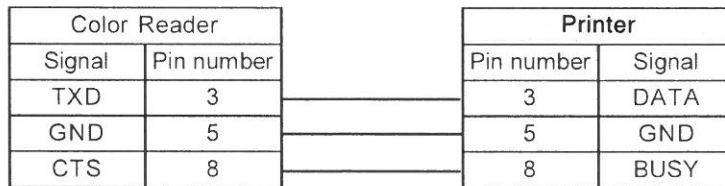

- The connections of Printer Cable CR-A75 (available as an optional accessory) correspond to the above diagram.
- When connecting or disconnecting the Color Reader and the printer, be sure that both units are switched off.
- Always switch on the Color Reader before switching on the printer.

Printing Data at Time of Measurement

- 1 Check that the POWER switch of the Color Reader is set to O (off) and that the printer is switched off, and connect the Color Reader to the printer.
 - When the printer being used is the printer, it should be connected to the Color Reader using Printer Cable CR-A75 (available as an optional accessory).

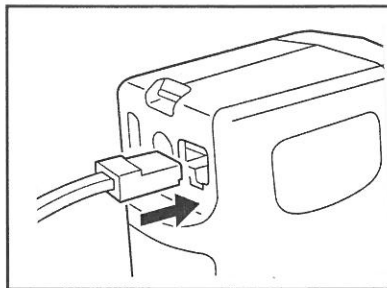

- 2 Set the POWER switch of the Color Reader to I (on) and then switch on the printer.
- 3 After performing white calibration, take measurements according to the procedure on p. 14. The measured data will be printed out each time a measurement is taken.

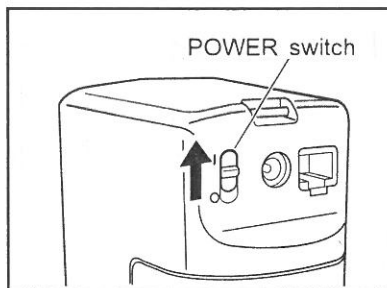

Printout Example

```

CIE
W 95.4 T-0.36
Y 91.1 x0.3127 y0.3289
W --.- T-.- Battery
Y 14.8 x0.3244 y0.3438
    
```

Print out when initial measurement display is displayed

Battery warning

ERROR MESSAGES

- If any of the following messages continue to be displayed after the suggested corrective action has been taken, contact the nearest authorized service facility.

Error message	Cause	Corrective action
Measure Again	Measurement was not taken correctly (Color Reader was moved during measurement, ambient light entered measurement aperture, etc.)	Take measurement again, being sure tip of Color Reader is flat against the specimen and that the Color Reader is not moved until the beep indicating completion of measurement has sounded.
Sample Too Dark	Reflectance of specimen is low.	Specimens with low reflectance cannot be measured.
Change Battery	Battery power is almost exhausted.	Replace batteries or use optional AC adapter.
Illumination Error	Lamp filament is broken or measurement circuit is malfunctioning.	Contact the nearest Konica Minolta authorized service facility.
Cal. Again	White calibration was performed using something other than the white calibration plate.	Use only the white calibration plate included with the Color Reader.

CAUTION

- The Color Reader should be used at temperatures between 0 and 40°C (32 and 104°F). Do not use the Color Reader at temperatures outside this range. Also, do not subject the Color Reader to sudden changes in temperature.
- Do not use the Color Reader in an explosive atmosphere, such as one containing gasoline fumes.
- Do not leave the Color Reader in direct sunlight or near sources of heat, such as stoves, etc. The internal temperature of the Color Reader may become much higher than the ambient temperature in such cases.
- Do not use the Color Reader in extremely dusty areas or in areas filled with smoke or chemical fumes.
- Do not use the Color Reader near equipment which produces a strong magnetic field (such as speakers, large motors, etc.)
- When the Color Reader is not in use, be sure to set the POWER switch to O (off) and cover the measurement aperture with the protective cap.
- Do not mix battery types or ages. Mixing battery types or ages could result in battery leakage, reduced battery life, or damage to the Color Reader.
- **Use only optional AC Adapter AC-A308 to supply power to the Color Reader from an AC outlet. Use the AC Adapter AC-A308 only with the rated power source.**
- Do not subject the Color Reader to strong impact or vibration.
- If the instrument malfunctions, do not disassemble the instrument or attempt to repair it yourself. Any necessary repairs should be performed only by a authorized service facility.

CARE AND STORAGE

- To protect the white surface of the white calibration plate from changing color due to exposure to ambient light, and also to protect it from being scratched or stained, be sure to close the cover of the white calibration plate after use.
- If the Color Reader becomes dirty, it can be cleaned by wiping with a soft, dry cloth. Do not use benzene, paint thinner, or other chemicals to clean the Color Reader.
- If the white calibration plate becomes dirty, it can be wiped with a clean, dry cloth. If the stain is difficult to remove, a soft cloth moistened with lens-cleaning fluid may be used. After cleaning the surface with lens-cleaning fluid, wipe the surface with a cloth moistened with water and then let the surface dry before use. If the white calibration plate is scratched or has a stain which cannot be **removed, it should be replaced. Contact the nearest Konica Minolta authorized service facility to purchase a replacement.**
- The Color Reader should be stored at temperatures between -20 and 40°C (-4 and 104°F). Do not store the Color Reader in areas subject to high temperatures, high humidity, or where condensation may occur.
- Do not leave or store the Color Reader in direct sunlight, inside a closed motor vehicle, in the trunk of a motor vehicle, or in any other area subject to extremely high temperatures.
- Do not store the Color Reader in extremely dusty areas or in areas filled with smoke or chemical fumes.
- If the Color Reader will not be used for more than two weeks, remove the batteries to avoid the possibility of damage due to battery leakage or corrosion.

ACCESSORIES

Standard Accessories

Soft Case CR-A68

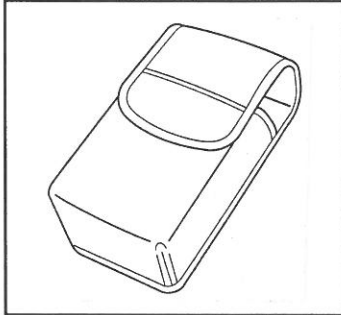

AA-size batteries (4)

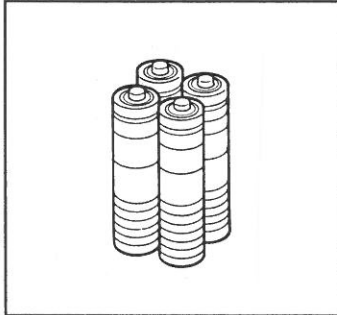

Wrist Strap CR-A73

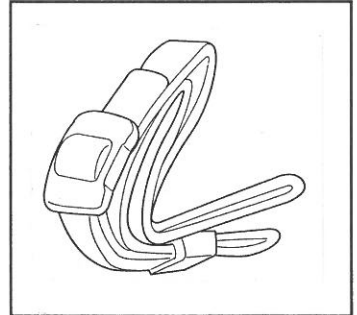

Protective Cap CR-A79

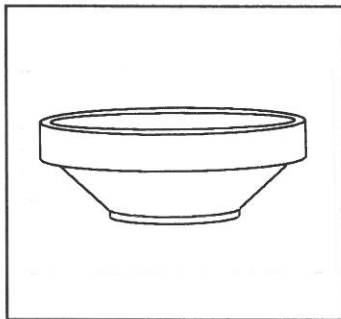

White Calibration Plate CR-A74

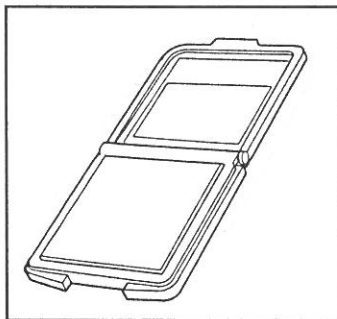

Optional Accessories

Printer Cable CR-A75

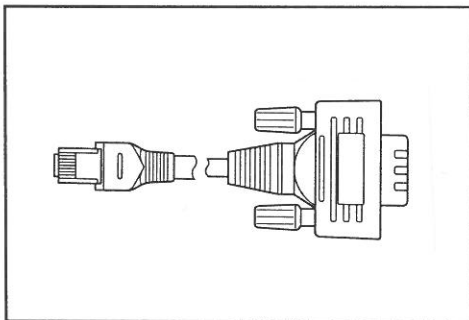

AC Adapter AC-A308

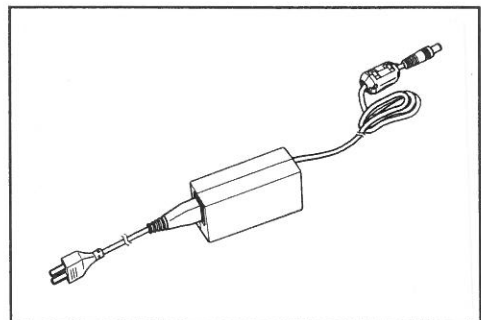

SPECIFICATIONS

Model	CR-14
Illuminating/viewing geometry	8° :de (8° illumination angle/diffuse viewing; specular component excluded)
Measuring area	Approximately Ø8mm
Light source	Gas-filled tungsten lamp
Detector	6 silicon photocells
Display modes	Whiteness Index: CIE, HUNTER, ASTM E313 Yellowness Index: ASTM E313, ASTM D1925 Yxy (Displayable: in CIE display mode)
Repeatability	Standard deviation of whiteness Index: CIE 0.5, HUNTER 0.1 (When measuring white calibration plate)
Minimum interval between measurements	Approx. 1.0 sec.
Power source	Four AA-size batteries or optional AC Adapter AC-A308
Battery life	Alkaline-manganese: Approx. 2000 measurements at 10-sec. intervals
Display	16-character × 2-row dot-matrix LCD
Operation temperature range	0 to 40°C (32 to 104°F); less than 85% relative humidity no condensation
Storage temperature range	-20 to 40°C (-4 to 104°F) no condensation
Dimensions (W × H × D)	59 × 158 × 85mm (2-5/16 × 6-1/4 × 3-3/8 in.)
Weight	360g (12.7 oz.) not including batteries
Standard accessories	White Calibration Plate CR-A74; Soft Case CR-A68; Protective Cap CR-A79; Wrist Strap CR-A73; AA-size batteries (4)
Optional accessories	AC Adapter AC-A308, Printer Cable CR-A75



KONICA MINOLTA