

Display Color Analyzer
CA-527/CA-410 Series
Probe + PC Software
CA-S40 Ver. 2.0

Instruction Manual



Please read before
using the instrument.



KONICA MINOLTA

■ Safety Symbols

The following symbols are used in this manual to prevent accidents that may occur because of incorrect use of the instrument.



**Denotes an instruction regarding a safety warning or note.
Read the instruction carefully to ensure safe and correct use.**



**Denotes an instruction regarding the risk of electric shock.
Read the instruction carefully to ensure safe and correct use.**



**Denotes an instruction regarding the risk of fire.
Read the instruction carefully to ensure safe and correct use.**



**Denotes a prohibited operation.
The operation must never be performed.**



**Denotes an instruction.
This instruction must be strictly adhered to.**



**Denotes a prohibited operation.
Never disassemble the instrument.**



This symbol indicates direct current (DC).

Notes on this Manual

- Copying or reproduction of all or part of the contents of this manual without the permission of KONICA MINOLTA is strictly prohibited.
- The contents of this manual are subject to change without prior notice.
- Every effort has been made in the preparation of this manual to ensure the accuracy of its contents. However, should you have any questions or find any errors, please contact your retailer or a KONICA MINOLTA-authorized service facility.
- KONICA MINOLTA will not accept any responsibility for consequences arising from the use of the instrument.
- The latest instruction manual can be downloaded from the following URL:
http://www.konicaminolta.com/instruments/download/instruction_manual/index.html

Formal designations of application software used in this manual

(Designation in this manual) (Formal designation)









Bluetooth	Bluetooth®
Windows, Windows 10	Microsoft® Windows® 10 Pro Operating System
Windows, Windows 11	Microsoft® Windows® 11 Pro Operating System
macOS, macOS Monterey	Apple® macOS® Monterey
macOS, macOS Ventura	Apple® macOS® Ventura
Excel	Microsoft® Office Excel



Trademarks

- “Microsoft”, “Windows”, “Windows 10”, and “Windows 11” are registered trademarks of Microsoft Corporation in the U.S.A. and other countries.
- “Apple” and “macOS” are registered trademarks of Apple Inc. in the U.S.A. and other countries.
- “Intel” and “Intel Core” are registered trademarks or trademarks of Intel Corporation in the U.S.A. and other countries. Other company names and product names mentioned in this manual are the registered trademarks or trademarks of their respective companies.

Safety Precautions

To ensure correct use of this instrument, read the following points carefully and adhere to them. After you have read this manual, keep it in a safe place where it can be referred to anytime a question arises.

	WARNING (Failure to adhere to the following points may result in death or serious injury.)
	Do not use the instrument in places where flammable or combustible gases (gasoline, etc.) are present. Doing so may cause a fire.
	Firmly push the cable plug completely into the outlet. Incomplete insertion may cause fire or electric shock.
	Always hold the plug itself when disconnecting the cable from an outlet. Pulling on the cable may damage it and cause a fire or electric shock. Also, do not insert or disconnect the plug with wet hands. Doing so may cause electric shock.
	Do not forcibly bend, twist, or pull the cords or cables. Also, do not scratch, or place heavy objects on the cables. Doing so may damage the cable and cause a fire or electric shock.
	Do not disassemble or modify the instrument. Doing so may cause a fire or electric shock.
	Take special care not to allow liquid or metal objects to enter the instrument. Doing so may cause a fire or electric shock. Should liquid or metal objects enter the instrument, turn the power OFF immediately, and contact the nearest KONICA MINOLTA-authorized service facility.
	The instrument should not be operated if it is damaged, or if smoke or odd smells occur. Doing so may cause a fire. In such situations, turn the power OFF immediately, and contact the nearest KONICA MINOLTA-authorized service facility.
	Do not insert or disconnect the plug with wet hands. Doing so may cause electric shock.

	CAUTION (Failure to adhere to the following points may result in injury or damage to the instrument or other property.)
	When cleaning the instrument, disconnect the cable. Failure to do so may result in electric shock.
	Do not place the instrument on an unstable or sloping surface. Doing so may result in the instrument dropping or overturning, causing injury. Be careful not to drop the instrument when carrying it as well.

Introduction

The CA-410 series and the CA-527 are instruments designed to measure the color, luminance, and flicker of various color displays. Please read this manual carefully before using the instrument.

Packing materials of the product

Be sure to keep all packing materials used for shipping the instrument (cardboard box, cushioning material, plastic bags, etc.). This instrument is a precision measuring instrument. When transporting the instrument to a service facility for maintenance or for other reasons, be sure to use the packing materials to minimize shock or vibration. If the packing materials are lost or damaged, contact a KONICA MINOLTA-authorized service facility.

Notes on Use

Operating Environment

- This instrument has been designed exclusively for indoor use. Outdoor use is prohibited.
- This instrument is composed of precision electronic components. Never disassemble the instrument.
- This instrument is a pollution level 2 product (equipment to be used primarily in manufacturing environments, laboratories, warehouses, and similar locations). This instrument should be used in environments where exposure to metallic dust or condensation is not a concern.
- This instrument is an overvoltage category I product (equipment for connection to circuits in which measures are taken to limit transient overvoltage to an appropriately low level).
- This instrument complies with Electrical equipment for measurement, control and laboratory use - EMC(Electromagnetic Compatibility) requirements - Part 1: General requirements (EU Harmonized Standards EN 61326-1:2021). Conformity verification is performed under KONICA MINOLTA's test conditions in an INDUSTRIAL ELECTROMAGNETIC ENVIRONMENT specified in the relevant harmonized standards. The limit of performance degradation when subjected to continuous disturbance during immunity testing is up to twice KONICA MINOLTA's repeatability specifications (Lv, x, y).
- Do not use the instrument at altitudes higher than 2,000 m.
- Take care to prevent foreign matter from entering the instrument. Using the instrument while subjected to intrusion of water or metals is extremely dangerous.
- Using the instrument in direct sunlight or near heating equipment can cause the internal temperature of the instrument to become much higher than the ambient temperature, resulting in malfunction. Do not use the instrument in such areas. Also, use the instrument in a well-ventilated environment.
- Avoid subjecting the instrument to sudden temperature changes and condensation.
- Do not use the instrument in areas where dust, smoke, or chemical gases are present, or in extremely humid environments.
- This instrument should be used in an environment with an ambient temperature between 10 and 35°C and a relative humidity of 85% or less. Use of the instrument outside this range will result in unsatisfactory performance.

System

- Do not subject the instrument to strong vibrations or impacts.
- Do not pull, forcibly bend, or apply excessive force to the connected cables and cords. Doing so may cause the cable or cord to break.
- The instrument should be connected to a power source with as little noise as possible.
- The instrument may cause interference if used near a television, radio, transceivers, etc.
- When restarting the instrument, wait several seconds after turning the power OFF before turning the power ON again.
- Do not turn the power off during writing to the memory such as calibration and measurement.
- The instrument may not operate properly due to the compatibility with the equipment connected to it such as a PC. Please check whether the instrument operates properly by yourself.
- Make sure to disconnect the USB connection between the probe and the PC and to turn off the power when the instrument is not in use.
- Periodic backup of important data and settings to another storage medium is recommended.
- Should the instrument break down, do not try to disassemble and repair the instrument. Consult with your nearest KONICA MINOLTA-authorized service facility.

Lens

- Before measurement, make sure that the lens surface is not dirty. You may not be able to perform correct measurement if there is dirt, dust, or finger mark on it, or if stain remains after cleaning.
- Do not touch the lens surface with hands.
- Avoid subjecting the instrument to sudden temperature changes under a high-humidity environment. It may fog the lens and hinder correct measurement.

Storing the Instrument

- This instrument should be stored at a temperature between 0 and 45°C with a relative humidity of 85% or less and no condensation. Storing the instrument in an environment with high temperatures and high humidity will result in unsatisfactory performance. Storing the instrument at or near room temperature and humidity is recommended.
- Make sure that the instrument is not subjected to condensation when stored. In addition, take care to prevent rapid temperature changes to prevent condensation from occurring when transporting the instrument to the storage location.
- Storing the instrument in direct sunlight or near heating equipment can cause the internal temperature of the instrument to become much higher than the ambient temperature, resulting in malfunction. Do not store the instrument in such areas.
- Do not store the instrument in areas where dust, smoke, or chemical gases are present. Doing so may cause deterioration in performance or a malfunction.
- Do not leave the instrument inside the cab or trunk of a vehicle. Otherwise, the temperature and/or humidity during midsummer or midwinter may exceed the allowable range for storage, resulting in a malfunction.
- Before storing, make sure that the lens is attached with the cap supplied as a standard accessory.

Notes on Cleaning

- If the instrument becomes dirty, wipe it with a soft, dry cloth. Never use organic solvents (such as naphtha or thinner) or other chemicals for cleaning.
- If there is dust or dirt on the optical system of a probe, use a blower to blow it off and then gently wipe it with a soft, dry cloth or with a lens-cleaning cloth. Never use organic solvents (such as naphtha or thinner) or other chemicals for cleaning.
- If you are unable to remove dirt from the instrument or if the instrument becomes scratched, contact a KONICA MINOLTA authorized service facility.

Notes on Transporting

- When transporting the instrument, be sure to use the packing materials to minimize shock or vibration.
- When sending the instrument in for service, package and send the instrument and all accessories.

Maintenance and Inspection

- To maintain measurement accuracy, the instrument should be inspected once a year. For information on inspection, contact the nearest KONICA MINOLTA-authorized service facility.

Disposal Method

- Make sure that the instrument, its accessories, and the packing materials are either disposed of or recycled correctly in accordance with local laws and regulations.

About This Manual

This manual is designed for those who possess basic knowledge of displays and relevant equipment.

Please read this manual carefully before using the instrument.

In the descriptions about probes in this manual, probes are described as "probe" where the type of probe is not specified.

For Those Who Want to Purchase Optional Accessories for This Instrument

This manual also explains how to use optional accessories available for this instrument.

If an explanation of how to use an optional accessory is given in this manual, its product name is also given.

Please read the explanation together with the manual supplied with the accessory.

Table of Contents

Safety Precautions	1
Introduction	2
Configuration of the CA-410 Series and the CA-527	6
1. CA-410 Series	6
2. CA-527	6
3. System Diagram (CA-410 Series)	7
4. System Diagram (CA-527)	8
Probe Guide	9
Probes (Including the CA-527)	10
1. About Probes	10
2. Probe Lineup (Including the CA-527) (All Probes are Provided with Lens Caps)	11
3. Standard Accessories	11
4. Optional Accessories	12
5. Description of Each Part of Probes	14
6. How to Set a Probe	15
7. How to Connect Cables	16
About Zero Calibration	19
1. How to Check Zero Calibration	19
Measurement Functions of Probes	19
1. Measurement Speeds	19
2. Measurement Synchronization Modes	20
3. Measurement Modes	21
User Memory	22
1. About Calibration Channels	22
2. About Targets	22
3. About User Calibration	23

PC Software CA-S40	25
PC Software CA-S40	26
Overview	27
System environment	28
Setup	28
1. Installing the software (Windows)	28
2. Uninstalling the software (Windows)	28
3. Installing the software (macOS)	28
4. Uninstalling the software (macOS)	28
Major functions	29
Operation flow	30
Notes on measurement	31
1. Notes on hardware operation	31
Operation Guide	32
Preparing and starting the software	33
1. Connect the instrument and start the software	33

Measurement	34
1. Chromaticity measurement	34
2. Common operations.....	37
3. Individual functions	37
4. Flicker measurement (JEITA/VESA)	39
5. Flicker measurement (FMA).....	40
6. Waveform measurement	41
7. VRR flicker measurement	
* Only functions when the CA-527 is	
connected	43
Measurement condition settings	46
1. Measurement condition settings <Setting>	
tab.....	46
2. Option settings <Info> tab.....	51
3. Command communication <Command> tab ..	53
User calibration and ND user correction	54
1. About user calibration and ND user correction	
<User Cal> tab.....	54
2. Calibration and correction procedure	54
3. Specifying the calibration coefficients	
<Settings> window	59
Data processor data	60
1. Handling of stored data	60
2. Handling of Log data	61
Appendix	62
Troubleshooting	63
Error message.....	64
Caution.....	65
Instruction.....	68
Information	70

Configuration of the CA-410 Series and the CA-527

1. CA-410 Series

The CA-410 series consists of the following three systems:

● Probes

Sensor units for measuring displays.

Can be connected to a PC to perform measurement (using PC software).

Can be connected to a data processor to perform measurement.

● Data Processor CA-DP40

Can connect up to ten probes simultaneously to perform measurement.

Can be connected to a PC so that it can be controlled from the PC (using PC software).

Note: • Advanced high-sensitivity probes CA-VP427A and CA-VP410A cannot be controlled by the data processor.

● PC software CA-S40

Can control a probe connected to a PC to perform measurement.

Can control a data processor connected to a PC to perform measurement.

The instruction manual for probes and PC software (this manual) contains the following descriptions about probes and the standard PC software, PC Software for Color Analyzer CA-S40:

- Handling procedure and specifications of probes
- How to install the PC software
- How to measure when the probe(s) or the data processor are connected to a PC

2. CA-527

The CA-527 consists of the following two systems:

Memo • The CA-527 color analyzer cannot be controlled by the CA-DP40 data processor.

● CA-527 color analyzer

Sensor units for measuring displays.

Can be connected to a PC to perform measurement (using PC software).

● PC Software CA-S40

Can control a probe connected to a PC to perform measurement.

The instruction manual for probes and PC software (this manual) contains the following descriptions about probes and the standard software, PC Software CA-S40 For Color Analyzers:

- Handling procedure and specifications of probes
- How to install the PC software
- How to measure when the probe is connected to a PC

3. System Diagram (CA-410 Series)

[Probe]

Advanced High Sensitivity Probe
High Sensitivity Probe
 CA-VP427A
 CA-VP427

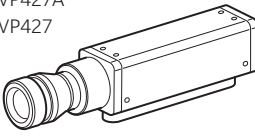

CA-VP410A
 CA-VP410

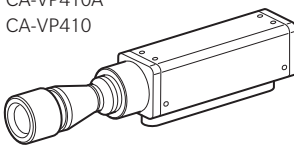

Normal Probe
 * CA-P427

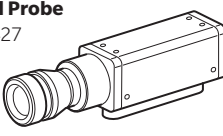

* CA-P410

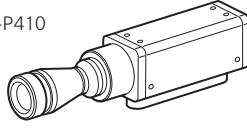

Mini Probe
 * CA-MP410

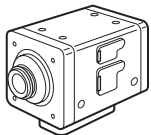

Other Probes
 CA-P427C
 CA-P410C
 CA-VP402
 CA-VP404
 CA-VP410T

* High-luminance models capable of measurement even at luminance levels as high as 30,000 cd/m² are also available.
 ** Advanced high-sensitivity probes CA-VP427A and CA-VP410A cannot be controlled by the data processor.

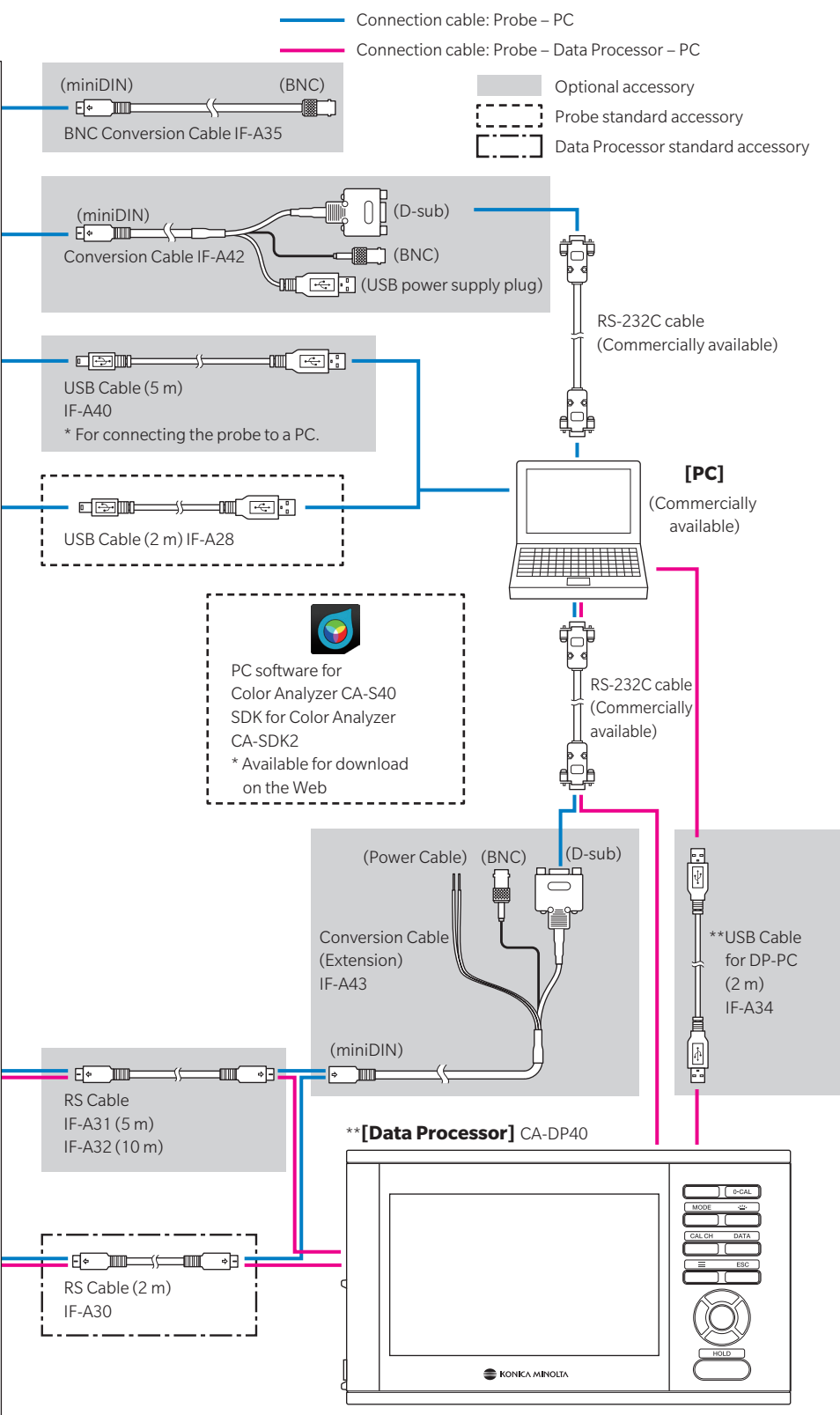

**Lithium-Ion Battery
 CM-A223



**AC Adapter
 AC-A312F

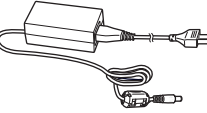

**Bluetooth Module
 CM-A219



Can only be used with a Windows OS

**Carrying Case
 CA-A01



4. System Diagram (CA-527)

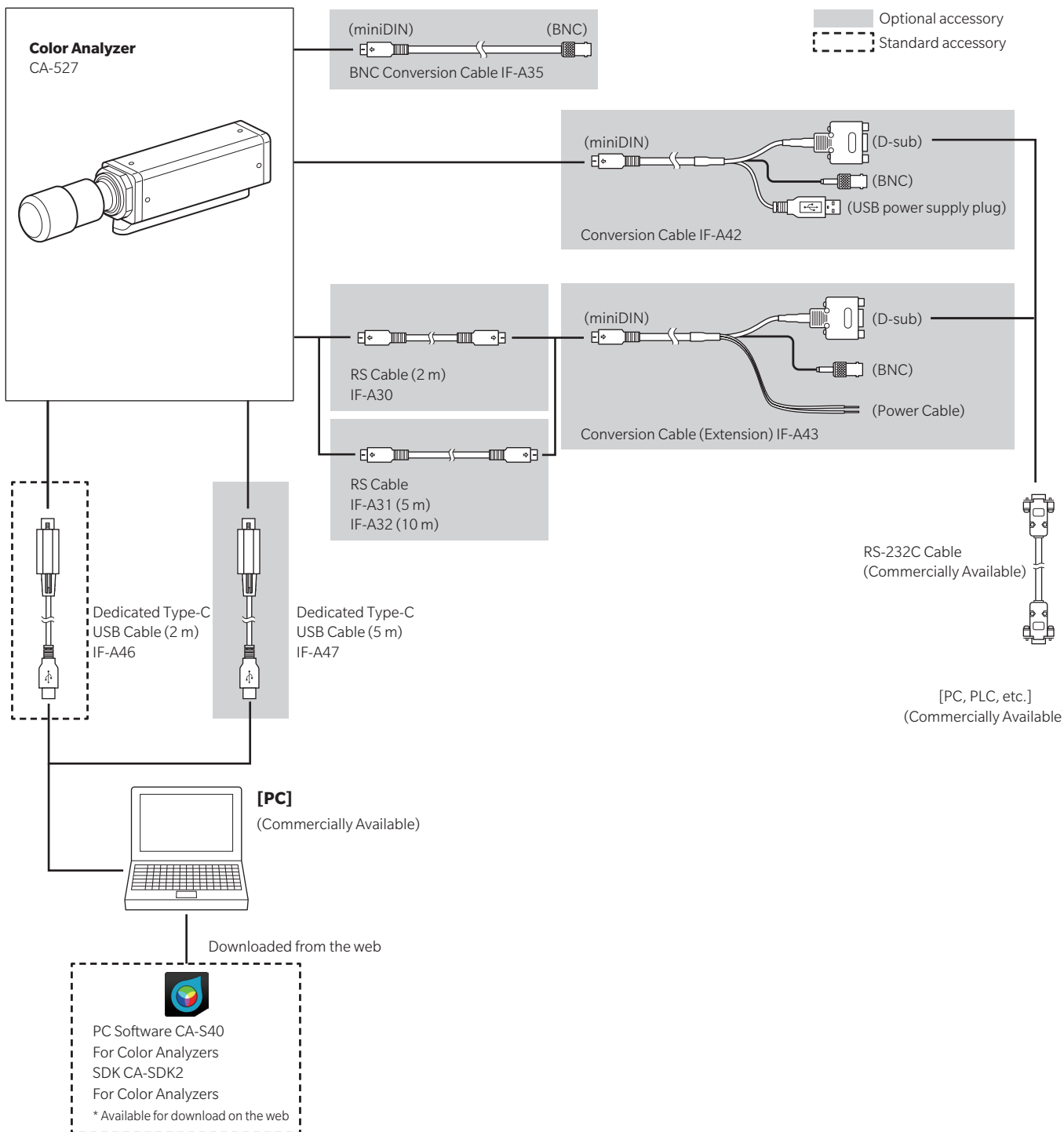

Memo • The CA-527 color analyzer cannot be controlled by the CA-DP40 data processor.

Probe Guide

Probes (Including the CA-527).....	10
1. About Probes	10
2. Probe Lineup (Including the CA-527) (All Probes are Provided with Lens Caps).....	11
3. Standard Accessories	11
4. Optional Accessories	12
5. Description of Each Part of Probes	14
6. How to Set a Probe	15
7. How to Connect Cables.....	16
About Zero Calibration	19
1. How to Check Zero Calibration.....	19
Measurement Functions of Probes.....	19
1. Measurement Speeds.....	19
2. Measurement Synchronization Modes	20
3. Measurement Modes.....	21
User Memory	22
1. About Calibration Channels	22
2. About Targets	22
3. About User Calibration	23

Probes (Including the CA-527)

1. About Probes

A CA-410 series probe or a CA-527 can be used to measure the luminance, chromaticity, and flicker values of displays. A probe (including the CA-527) can be controlled in the following three ways:

- You can connect a probe to a PC and control it from PC software to perform measurement. By using the standard software, PC Software CA-S40 For Color Analyzers, you can select one of the probes connected to a PC via USB and control it to perform measurement.

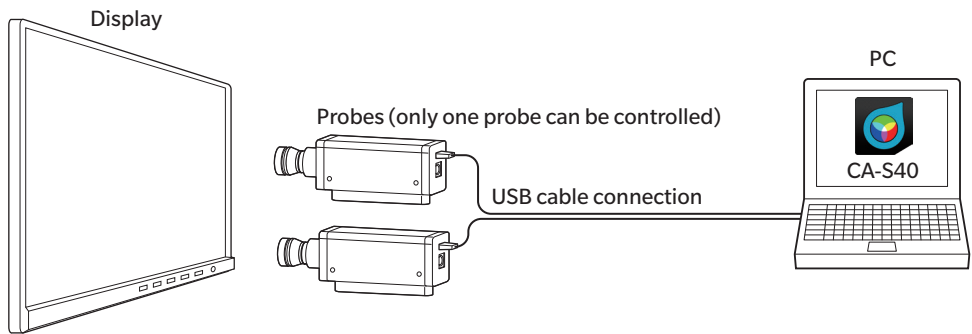

- You can connect a probe to a data processor and control it from the data processor to perform measurement. Multiple probes can be controlled simultaneously to perform measurement.
Note: • Advanced high-sensitivity probes CA-VP427A and CA-VP410A and the CA-527 cannot be controlled by the data processor.

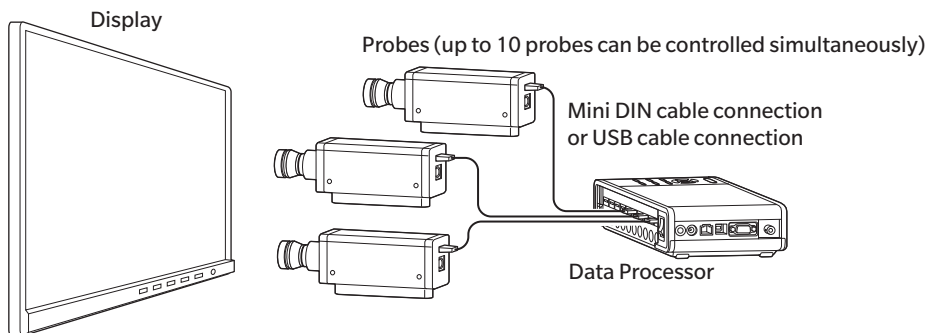

- You can connect a probe to a data processor, connect the data processor to a PC, and control it from PC software to perform measurement. By using the standard software, PC Software for Color Analyzer CA-S40, you can select one of the probes connected to the data processor and control it to perform measurement.
Note: • Advanced high-sensitivity probes CA-VP427A and CA-VP410A and the CA-527 cannot be controlled by the data processor.

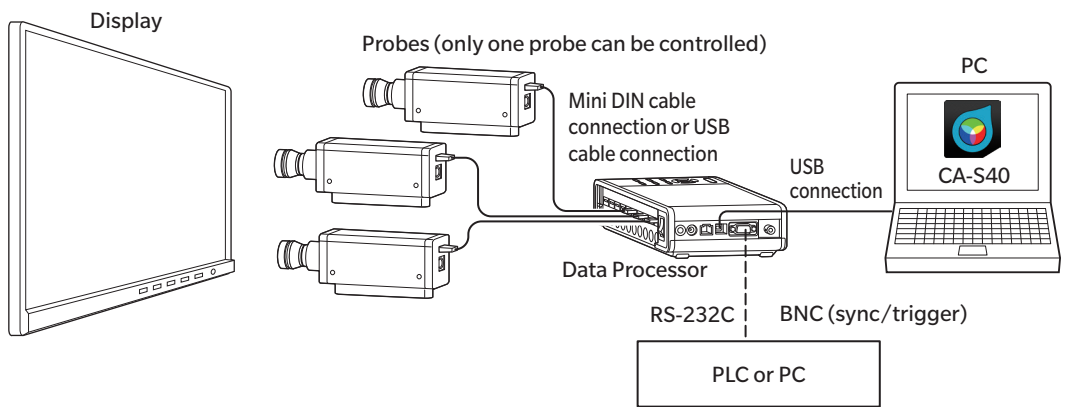

2. Probe Lineup (Including the CA-527)

(All Probes are Provided with Lens Caps)

The following probes are available according to the application.

Model	Name	Description
CA-527	ø27 Color Analyzer	Color analyzer with a measurement area of 27 mm
CA-P427	ø27 Probe	Probe with a measurement area of 27 mm
CA-P427H	ø27 Probe for high luminance	High-luminance probe with a measurement area of 27 mm
CA-P410	ø10 Probe	Probe with a measurement area of 10 mm
CA-P410H	ø10 Probe for high luminance	High-luminance probe with a measurement area of 10 mm
CA-MP410	ø10 mini Probe	Compact probe with a measurement area of 10 mm
CA-MP410H	ø10 mini Probe for high luminance	Compact high-luminance probe with a measurement area of 10 mm
CA-VP427	ø27 High Sensitivity Probe	High-sensitivity probe with a measurement area of 27 mm
CA-VP427A	ø27 Advanced High Sensitivity Probe	Advanced high-sensitivity probe with a measurement area of 27 mm
CA-VP410	ø10 High Sensitivity Probe	High-sensitivity probe with a measurement area of 10 mm
CA-VP410A	ø10 Advanced High Sensitivity Probe	Advanced high-sensitivity probe with a measurement area of 10 mm
CA-P427C	ø27 Probe (CIE 170-2:2015 compliant)	CIE 170-2:2015-compliant probe with a measurement area of 27 mm
CA-P410C	ø10 Probe (CIE 170-2:2015 compliant)	CIE 170-2:2015-compliant probe with a measurement area of 10 mm
CA-VP402	ø2 Small Spot Probe	Probe with a measurement area of 2 mm
CA-VP404	ø4 Small Spot Probe	Probe with a measurement area of 4 mm
CA-VP410T	ø10 LWD Probe (200 mm)	Probe with a measurement area of 10 mm and a measurement distance of 200 mm

- Note:
- High-sensitivity probes CA-VP427 and CA-VP410, advanced high-sensitivity probes CA-VP427A and CA-VP410A, small spot probes CA-VP402 and CA-VP404, and LWD probe CA-VP410T cannot measure flicker in CA-310 Mode.
 - Advanced high-sensitivity probes CA-VP427A and CA-VP410A and the CA-527 cannot be controlled by the data processor.
 - Use of a high-luminance probe is recommended for measuring a display that instantaneously shows high luminance, such as CRTs.
 - The CA-VP402 probe is designed for measurement of displays with a high pixel density, such as micro OLED displays. The pixels within the measurement area may be insufficient when measuring smartphone displays or other displays, and measured values may be unreliable due to the influence of position reproducibility.

3. Standard Accessories

● Hoods and lens caps

Use	Hood		Lens cap	
	Model	Name	Model	Name
For a CA-527 color analyzer	CA-H24	Hood for ø27 probe	CA-H25	Lens Cap
For a ø27 probe	CA-H12	Hood for ø27 Probe	CA-H13	Lens Cap for ø27 Probe
For a ø10 probe	CA-H14	Hood for ø10 Probe	CA-H15	Lens Cap for ø10 Probe
For a ø10 mini probe	CA-H16	Hood for ø10 Mini Probe	CA-H17	Lens Cap for ø10 Mini Probe
For a ø27 high-sensitivity probe and ø27 advanced high-sensitivity probe	CA-H18	Hood for ø27 High Sensitivity Probe	CA-H19	Lens Cap
For a ø10 high-sensitivity probe and ø10 advanced high-sensitivity probe	CA-H20	Hood for ø10 High Sensitivity Probe	CA-H21	Lens Cap
For a ø2 Small Spot Probe	CA-H22	Hood for ø2 Small Spot Probe	CA-H19	Lens Cap
For a ø4 Small Spot Probe	CA-H23	Hood for ø4 Small Spot Probe	CA-H21	Lens Cap
For a ø10 LWD Probe	—	—	CA-H21	Lens Cap

Probes (Including the CA-527)

Memo • Be sure to connect the included USB cable to the product.

● USB cable (2 m) IF-A28 (* For the CA-410 series)

Connects a probe to a data processor or a PC via USB.

How to connect: Refer to page 16.

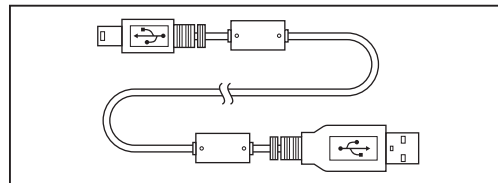

● Dedicated Type-C USB cable (2 m) IF-A46

Connects the CA-527 to a PC.

How to connect: Refer to page 16.

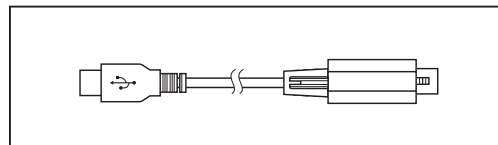

● PC Software for Color Analyzer CA-S40

Controls a probe or data processor connected to a PC via USB to perform measurement.

For how to use it, refer to the instruction manual for the PC software.

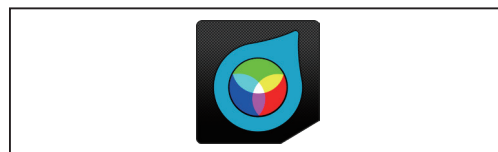

● SDK for Color Analyzer CA-SDK2

A library for users to create programs on their own.

* PC Software CA-S40 and SDK CA-SDK2 are available for download from the following product support webpage:

<https://www.konicaminolta.com/instruments/download/>

● Instruction Manual (this manual)

Please read before using the instrument.

4. Optional Accessories

● Conversion Cable IF-A42

Connects a probe to a PC or PLC (sequencer) via RS-232C and inputs synchronization signals to the probe.

How to connect: Refer to page 16.

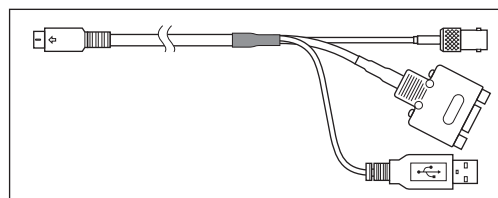

● Conversion Cable (Extension) IF-A43

Connects to a probe via a Probe-DP RS Cable IF-A30/A31/A32 for longer distance connections. Connects to a PC or PLC (sequencer) via RS-232C and inputs synchronization signals to the probe.

How to connect: Refer to page 16.

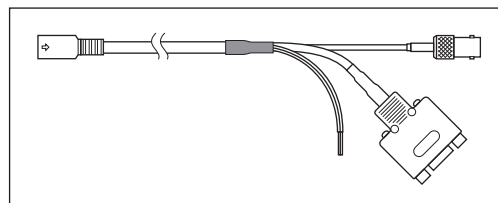

● BNC Conversion Cable IF-A35

Inputs synchronization signals to the probe.

How to connect: Refer to page 18.

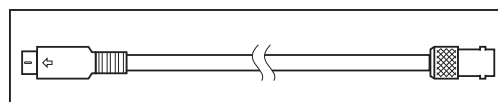

● USB Cable (5 m) IF-A40

For connecting the probe to a PC.

How to connect: Refer to page 16.

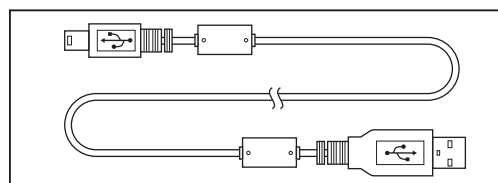

- **Dedicated Type-C USB cable (5 m) IF-A47**

Connects the CA-527 to a PC.

How to connect: Refer to page 16.

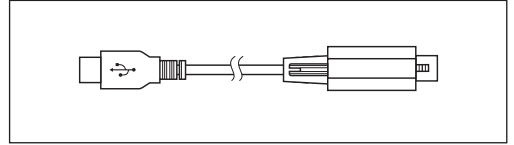

- **RS cable (2 m, 5 m, 10 m) IF-A30, 31, 32**

Connects the CA-527 to a PLC or a similar device via RS-232C.

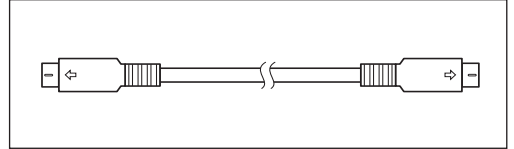

5. Description of Each Part of Probes

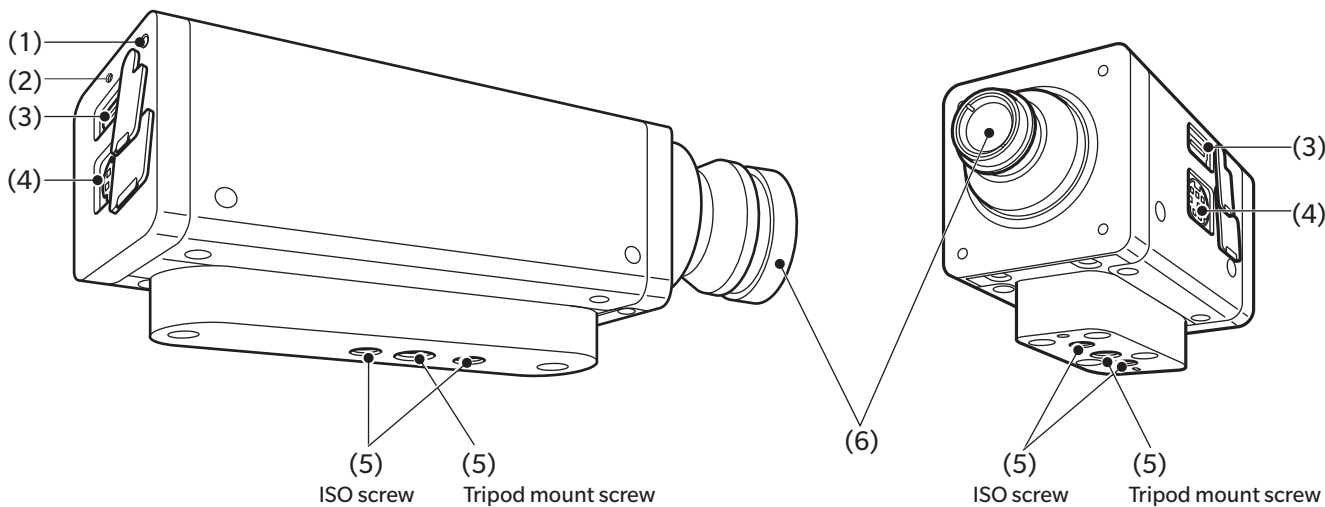

● Probe other than mini

Note: The CA-P427, P427H, P410, P410H, and the CA-527 have another tripod mount screw on the front side of the ISO screw. For details, refer to the dimensions.

● Mini probe

Note: Mini probes have screws for jigs and cable clamps. For details, refer to the dimensions.

(1) Status indicator

Located on the rear of all probes to indicate the status of the probe.

No power supply: Off

During measurement or zero calibration: Off

Memory error: Blinking (On for 0.2 sec, then Off for 0.2 sec)

Zero calibration not performed: Blinking (On for 1 sec, then Off for 0.2 sec)

Measurement possible: On (even when measurement is not possible due to the setting of an invalid synchronization frequency or integration time in INT, EXT, or MANUAL sync mode, without displaying that state)

(2) USB cable locking plug screw hole (CA-527 only)

Insert a locking plug screw into this hole to fix the USB cable IF-A46/47 in place.

(3) USB connector

For USB connection with a data processor or a PC, connect the USB cable IF-A28 (IF-A46 in the case of the CA-527) supplied as a standard accessory.

(4) RS-232C connector

For RS-232C connection to a data processor, connect the mini DIN cable IF-A30/31/32 for the data processor to the RS-232C connector.

Note: • Advanced high-sensitivity probes CA-VP427A and CA-VP410A and the CA-527 cannot be controlled by the data processor.

For RS-232C connection with a PLC or PC, connect an optional conversion cable IF-A42.

Use a conversion cable IF-A42/43 or a BNC conversion cable IF-A35 to input the display's vertical synchronization signals, which are used for measurement in "EXT" measurement synchronization mode.

(5) Screw holes

There are two types of screws for securing a probe:

Tripod mount screw: Used for mounting the probe on a tripod. The depth is 6 mm.

ISO screw: Used for securing the probe to jigs. Use an ISO 5 mm screw and the depth is 6 mm.

- The distance from each screw to the end of the optical column is the same as that for a CA-310 series probe. (Excluding mini probes, the CA-VP402, the CA-VP404, and the CA-VP410T.)
- The position of the optical axis (in the height direction) is the same as that for a CA-310 series probe.

(6) Receptor

Make this part face perpendicular to a display to perform measurement.

6. How to Set a Probe

1 Secure the display.

2 Secure the probe in a way to place its end 30 mm *1 away from the display surface.

Be sure to set it perpendicular to the display.

*1: L = 10 mm for mini probes.

L = 28 mm for the CA-VP402.

L = 200 mm for the CA-VP410T.

*2: No hood is used for the CA-VP410T.

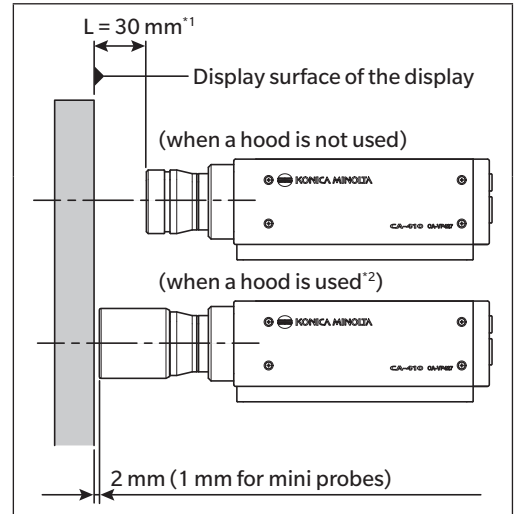

Notes on setting

- When measuring displays with high view angle dependence, you can obtain a higher measurement reproducibility by not changing the setting angle θ for every measurement. In particular, the CA-VP410 high-sensitivity probe, the CA-VP410A advanced high-sensitivity probe, the CA-VP402 and CA-VP404 small spot probes, and the CA-527 have a large aperture angle, which has a greater effect on the viewing angle. When measuring displays with a high view angle dependence, run user calibration and use the probe without rotating it from the calibrated position.
- Use of the hood supplied as a standard accessory not only blocks ambient light but also makes it easier to achieve a proper measurement distance and an angle of 90° .
 - The guaranteed-accuracy measurement distance for a $\phi 27$ probe is $L = 30 \text{ mm} \pm 10 \text{ mm}$.
 - The guaranteed-accuracy measurement distance for a $\phi 10$ probe is $L = 30 \text{ mm} \pm 5 \text{ mm}$.
 - The guaranteed-accuracy measurement distance for a mini probe is $L = 10 \text{ mm} \pm 5 \text{ mm}$.
 - The guaranteed-accuracy measurement distance for the CA-VP402 is $L = 28 \text{ mm} \pm 2 \text{ mm}$.
 - The guaranteed-accuracy measurement distance for the CA-VP404 is $L = 30 \text{ mm} \pm 2 \text{ mm}$.
 - The guaranteed-accuracy measurement distance for the CA-VP410T is $L = 200 \text{ mm} \pm 2 \text{ mm}$.
 - The guaranteed-accuracy measurement distance for the CA-527 probe is $L = 30 \text{ mm} \pm 5 \text{ mm}$.
- When strict low-luminance measurement is required, perform measurement in a dark room with no external light. Even when measuring in a dark room, the ambient light from the display itself may act as an external light. In such situations, light shielding using a hood is recommended. If strict limitations are required, compare measurement results from a general luminance meter such as the CS-2000 or CS-3000, and verify whether using a hood has any effect.

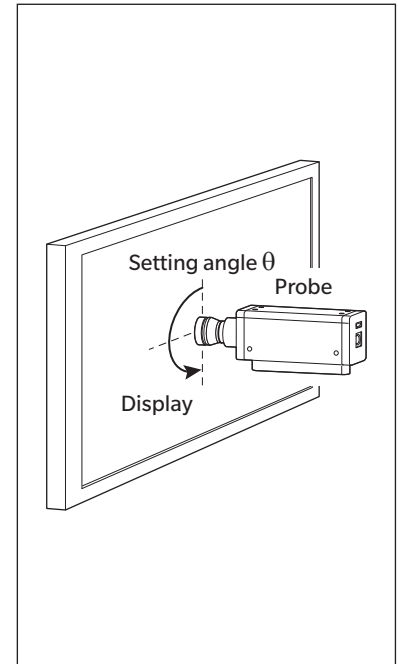

[Relationship between specification table measurement area and guaranteed-accuracy measurement distance]

The "measurement area" indicated in the specification table is a value that satisfies the design value at the nominal guaranteed-accuracy measurement distance.

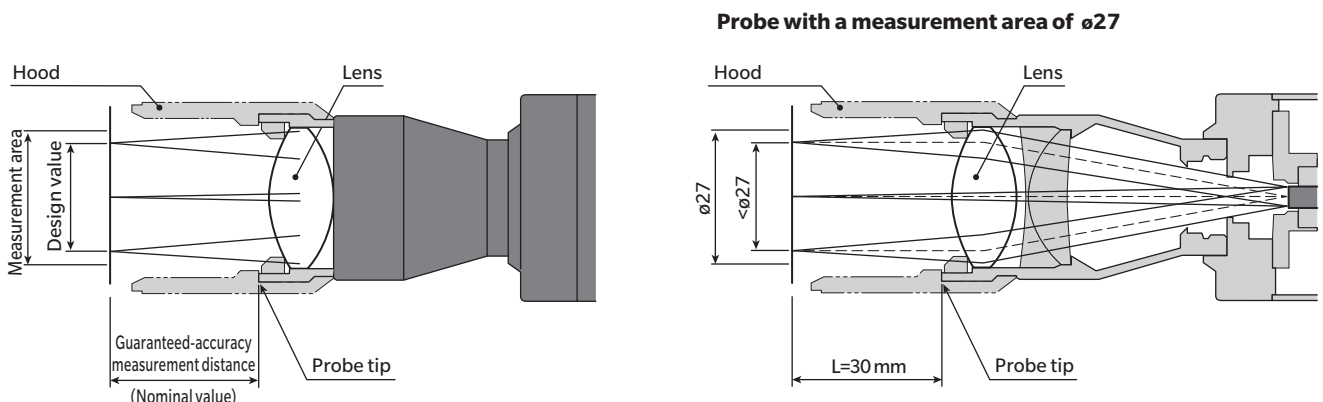

7. How to Connect Cables

A probe has a USB connector for connecting a USB plug and a connector for connecting an RS-232C mini DIN plug. Before connection, make sure that power is not supplied to the probe and the external device. Be sure to connect a cable plug to the specified connector. Be careful not to apply load to the cable connector during wiring. Fixing the cable with a steady load on the connector may result in a communication failure.

Memo / • Be sure to connect the included USB cable to the product.

USB connection to PC

- Connect the USB mini B plug of the supplied USB cable IF-A28 to the USB connector of the probe. Connect the USB plug on the other side of the cable to the USB connector of the PC.

●Using IF-A28

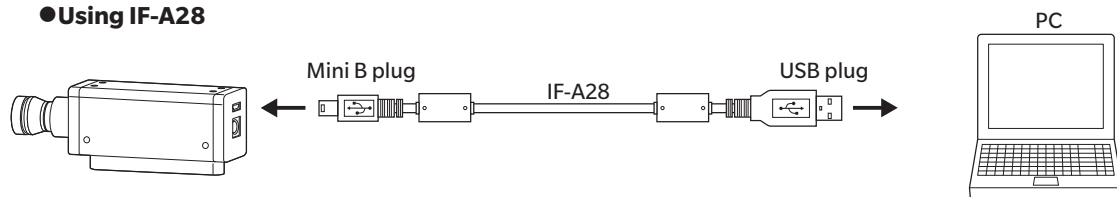

- Connect the USB Type-C plug of the USB cable IF-A46 supplied as standard with the CA-527 to the USB connector of the probe. Connect the USB plug on the other side of the cable to the USB connector of the PC. When connecting the IF-A46, use a flathead screwdriver to tighten the screw of the Type-C locking plug.

●Using IF-A46

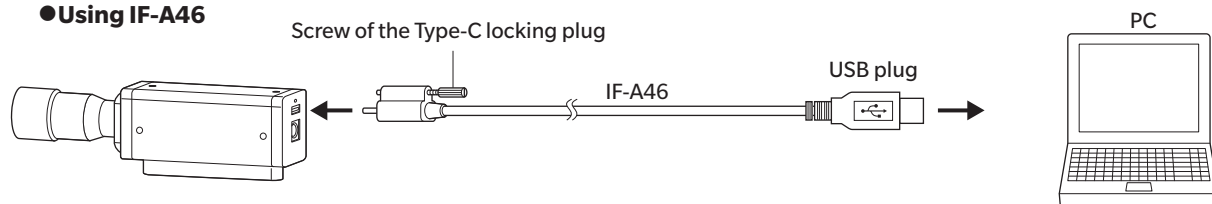

RS-232C connection to PC or PLC

- Connect the mini DIN plug of an optional conversion cable IF-A42 to the RS-232C connector of the probe, and the D-sub plug to the RS-232C connector of the PC or PLC via a cross cable.

●Using IF-A42

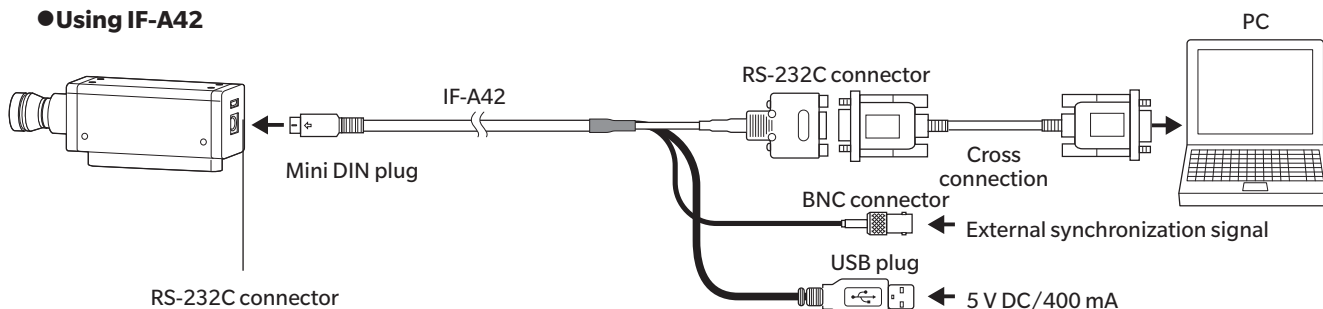

- Connect the mini DIN plug of the IF-A30 cable included with the data processor or an optional IF-A31/A32 cable to the RS-232C connector of the probe. Connect the mini DIN jack of an optional conversion cable IF-A43 to the IF-A30/A31/A32, and the D-sub plug to the RS-232C connector of the PC or PLC via a cross cable.

●Using IF-A43

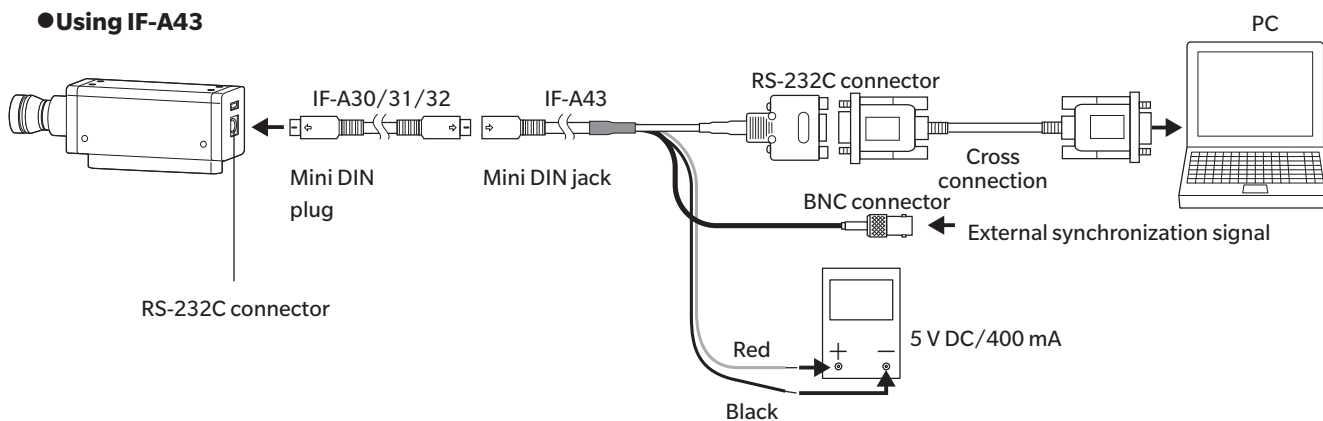

- The baud rate of the probe is set to 38,400 bps. Power must be supplied from the USB plug when using an optional conversion cable IF-A42, or from the power cable when using an optional conversion cable IF-A43. To control a probe from a PC via RS-232C, use the supplied SDK (CA-SDK2). For the specifications of the SDK and how to use it, refer to the instruction manual for CA-SDK2.

Probes (Including the CA-527)

RS-232C connector pin No. and functions

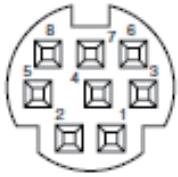

Mini-DIN 8-pin (female)

Pin No.	Pin function	Details
1	ExSync or Trigger IN	3.3 V CMOS input level (input up to 5 V) or 1.8 V CMOS input level (selectable)*, Max. 240 Hz
2	Trigger OUT	5 V CMOS output level
3	External power supply (5 V)	CA410 series: 4.9 V to 5.5 V CA-527: 4.7 V to 5.3 V
4	TxD	
5	GND	
6	RTS	
7	RxD	
8	CTS	

* The 1.8 V CMOS input level can be set for probes with a serial number for which the fourth digit from the left is 2 or higher (XXX2XXXX).

Inputting trigger and external synchronization signals to the probe

Trigger timing diagram

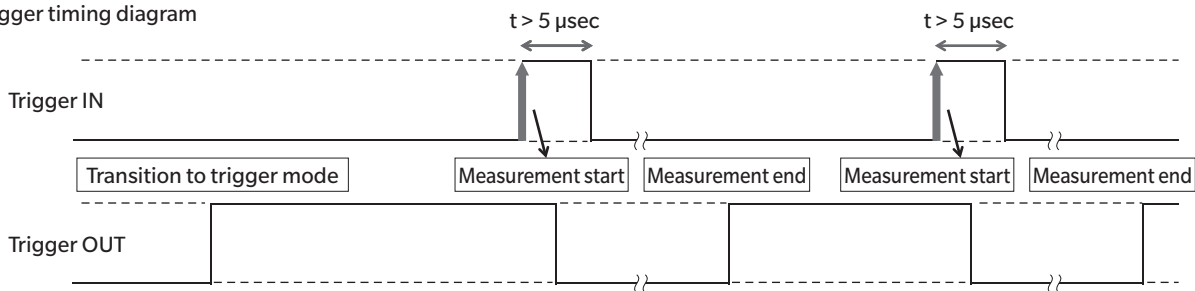

- Input the signals to the BNC plug of an optional conversion cable IF-A42/A43 or an optional BNC conversion cable IF-A35.

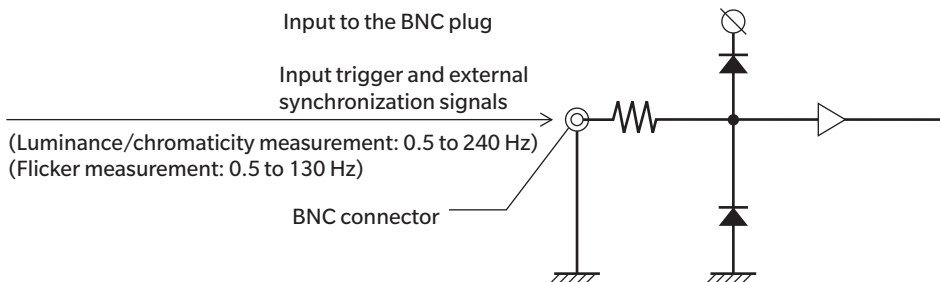

Connecting to a CA-DP40 data processor

Connect using a mini DIN cable or a USB cable.

- For RS-232C connection, connect the mini DIN plug of the RS mini DIN cable IF-A30 (or IF-A31 or IF-A32) for the data processor to the RS-232C connector of the probe and the probe RS-232C connector of the CA-DP40 data processor.

● Connection via a mini DIN cable (using IF-A30/31/32)

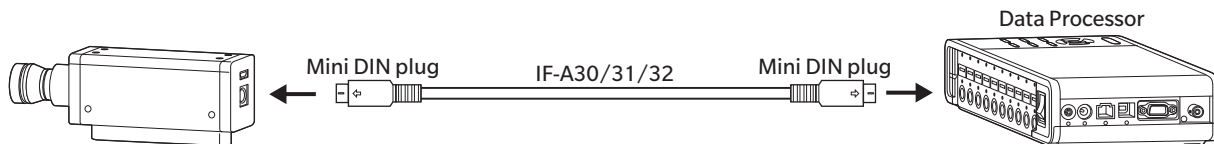

- For USB connection, connect the USB mini B plug of the supplied USB cable IF-A28 to the USB connector of the probe. Connect the USB plug on the other side of the cable to the probe USB connector of the CA-DP40 data processor.

● Connection via a USB cable (using IF-A28)

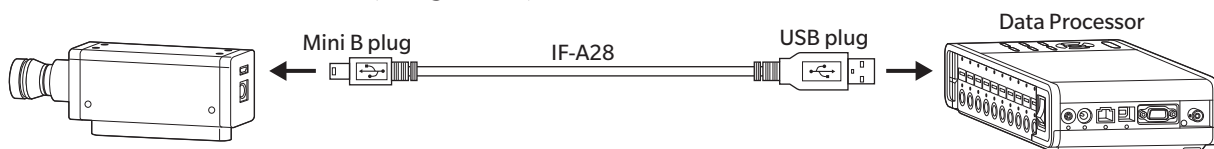

Note: • Advanced high-sensitivity probes CA-VP427A and CA-VP410A and the CA-527 cannot be controlled by the data processor.

About Zero Calibration

Zero calibration performs zero point adjustment while blocking entry of light into the probe's receptor. Be sure to perform zero calibration whenever the instrument is started.

Notes on zero calibration

- Perform zero calibration if the ambient temperature has changed.
- Do not direct the end of the probe toward an illuminant with high luminance during zero calibration.

1. How to Check Zero Calibration

To check whether zero calibration has been performed correctly, block entry of light into the end of the probe using a blackout curtain, etc. so that the receptor is not exposed to light.

- Zero calibration has been performed correctly if zero is displayed for the Lv section on the controller's measured value display. If a value other than zero is displayed, perform zero calibration again.

Measurement Functions of Probes

1. Measurement Speeds

A probe has the following four modes (measurement speeds), which are available according to the purpose. A probe outputs every measured value and a PC or data processor connected to it can retrieve all of them through communication. Generally, however, not all measured values are displayed but values are displayed at an appropriate interval.

FAST mode

Requires short measurement time, but may compromise measurement repeatability for low-luminance measurements.

SLOW mode

Repeats FAST mode measurements several times. Use this mode when you want to perform measurement with high repeatability.

AUTO mode

Switches FAST, SLOW, and setting with a further longer integration time automatically depending on the luminance level. Normally, this is the recommended setting.

LTD.AUTO mode

Switches between FAST and SLOW settings automatically depending on the luminance level.

Notes on selecting the measurement speed

- The currently selected measurement speed setting is stored in the probe. The set measurement speed will be used at the next start-up.

2. Measurement Synchronization Modes

Measurement synchronization modes are designed to select an integration time according to the vertical scanning frequency of a display. The time required for one measurement depends on the measurement speed setting, and is an integer multiple of the integration time plus the time required for communication, calculation, etc. Select a mode suitable for the type of the display to be measured.

Measurement synchronization mode	Description of mode	Integration time (Double-Frame)	Vertical scanning frequency	Display's vertical synchronization signal input
NTSC	Mode for measuring NTSC displays	33.3 ms	59.94 Hz	Not required
PAL	Mode for measuring PAL and SECAM displays	40.0 ms	50 Hz	Not required
EXT	Mode for measuring while synchronizing with the display's vertical synchronization signal input (refer to page 18 for how to input vertical synchronization signals)	(1 vertical scanning period) ×2	0.50 to 240.00 Hz (For FMA: 0.50 to 130.00 Hz)	Required
UNIV	Mode that allows measurement with an integration time of 100 ms Available when the display's vertical scanning frequency is unknown or when input of the vertical synchronization signal is not possible. (When the light source fluctuates sharply due to PWM control, etc., fluctuations in the measured values may increase.)	100 ms	—	Not required
INT	When the display's vertical synchronization signal is known, set that information so that it can be used for measurement.	(Set vertical scanning period) ×2	Settable range 0.50 to 240.00 Hz (For FMA: 0.50 to 130.00 Hz)	Not required
MANUAL	Mode that allows you to specify the integration time	Settable range 4.0 to 4000.0 ms (For FMA: 7.7 to 4000.0 ms)	—	Not required

- Memo** /
- On a flickering LCD, the screen is fluctuating at half the frequency of the vertical scanning frequency. When you measure a display in this state, the luminance and the chromaticity vary if you set the same integration time as the vertical scanning frequency.
When measuring with the measurement synchronization mode set to MANUAL, set the integration time double (or another even multiple of) the vertical scanning frequency to ensure stable LCD measurement.
 - The integration time can also be set to Single-Frame (half the integration time with Double-Frame) when the measurement mode is NTSC, PAL, EXT, or INT.
Note: Integration time is fixed to Double-Frame when using a data processor.

Relationship between measurement speed and measurement synchronization mode

The measurement time (integration time) is determined by the selected measurement synchronization mode.

Also, the measurement speed (number of measurements/outputs possible per second) is determined by the measurement synchronization mode and the following conditions:

- Luminance of the display to be measured
- Measurement mode
- Data output method (RS-232C or USB)
- Baud rate (for RS-232C)
- Number of probe to be used

Typical measurement speeds are described in the specifications.

3. Measurement Modes

A probe has the following measurement modes:

Measurement mode	Description of mode
xyLv mode	Mode for displaying and outputting chromaticity coordinates x, y and luminance Lv
TduvLv mode	Mode for displaying and outputting correlated color temperature T, color difference from blackbody locus duv, and luminance Lv
u'v'Lv mode	Mode for displaying and outputting u'v' chromaticity diagram coordinates (CIE 1976 UCS chromaticity diagram) and luminance Lv
Flicker mode	Displays the flicker amount in the contrast method (AC/DC). The unit is “%”.
	Displays the flicker amount in the JEITA/VESA method. The unit is “dB”.
XYZ mode	Mode for displaying and outputting tristimulus values XYZ
λ dPeLv mode	Mode for displaying and outputting dominant wavelength λ d, excitation purity Pe, and luminance Lv

* Under the initial settings, the mode is set to xyLv mode at the start-up.

User Memory

1. About Calibration Channels

A probe has calibration channels from CH00 to CH99 (100 channels in total).

The following can be set for each of CH00 to CH99:

- (1) Correction coefficient for user calibration
- (2) Target
- (3) ID

CH00 is a channel for calibration in accordance with the Konica Minolta calibration standard. It can only be used for setting IDs.

Users can use CH01 to CH99 for calibration or saving targets.

Under the initial settings, CH01 to CH99 are also provided with the same Konica Minolta calibration value as with CH00. Each channel can also be assigned with an ID.

How the memory is used during user calibration

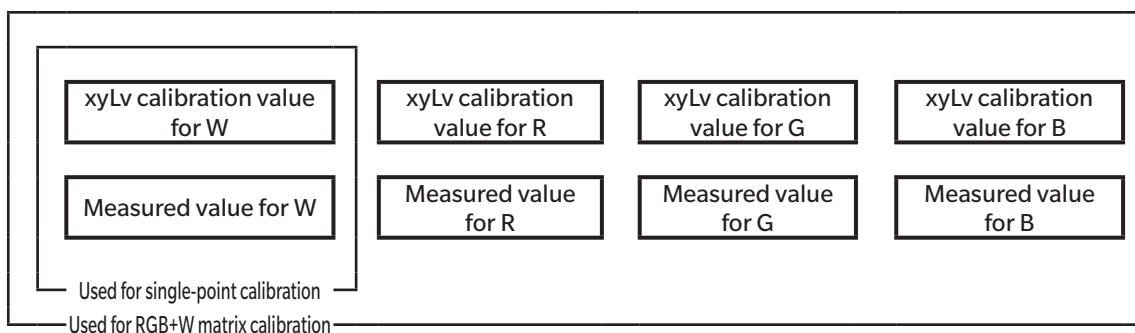

2. About Targets

Targets become the base color for measuring how different another measurable color is, which is required for color difference display. Targets can be set for each probe of each calibration channel.

Targets are set after the following operations:

- (1) User calibration: After user calibration, the calibration value is set as a target at the same time.
- (2) Setting/changing a target: Setting and changing targets are CA-DP40 functions.

To be performed in the following cases:

- To set a target in calibration channel CH00
 - To set a different color from user calibration as a target in a user-calibrated calibration channel
 - To perform measurement without performing user calibration but in accordance with the Konica Minolta calibration standard and to use color difference display
-
- If a correction coefficient for user calibration is input, a target is set at the same time, which erases the previously set target.
 - To change a set target, set/change a target. Changing a target does not change the correction coefficient set for user calibration.

In a same calibration channel, the target is saved to common channel, irrespective of measurement mode.

As a result, the target set last is saved, irrespective of measurement mode.

For one calibration channel and one probe number:

- The correction coefficient for user calibration is common to xyLv mode, TduvLv mode, u'v'Lv mode, and XYZ mode.
- The target is common to all measurement modes.

3. About User Calibration

- User calibration allows users to set their own correction coefficients to the calibration channel of the probe by measuring any display colors and setting calibration values (x, y, Lv) to the instrument.
Afterward, the value corrected with the specified correction coefficients will be displayed/output for every measurement.
- Two types of user calibration can be performed for a CA-410 series probe: single-point calibration and RGB+W matrix calibration.
- On the CA-527, you can perform ND user correction by selecting the [with ND Calibration] check box before performing single-point calibration or RGB+W matrix calibration.
- RGB+W matrix calibration has been performed when the instrument is shipped from the factory.
- User calibration is performed independently for each probe.
- User calibration can be performed for every calibration channel (except for CH00).
- When a probe is used for the first time after being shipped from the factory, measurement is performed in accordance with the Konica Minolta calibration standard in all calibration channel. You can use user calibration to apply the following corrections to measurements based on the specified correction coefficients.
 - (1) Corrects the difference in the reading due to the deviation of spectral response from the CIE 1931 color-matching function.
 - (2) Corrects the difference in the readings between probes when multiple probes are used for measurement.
- When user calibration is performed, the color is set to the same calibration channel as its target at the same time. Targets become the base color for displaying how different another measurable color is, which is used as the base for color difference display.

When multiple probes are used

When using multiple probes for measurement, you can correct the difference in the readings by performing user calibration as follows:

When the target color value for the display to be measured is known

Make a standardized color display on a standard display and perform user calibration for all probes.

When the target color value for the display to be measured is not known

- (1) Determine one master probe.
- (2) Set the measurement mode to xyLv mode, make the master probe face perpendicular to the display on which the target color is displayed, and perform measurement.
- (3) Record the measured value.
- (4) Using the display on which the target color is displayed and the value displayed in (3), perform user calibration for other probes.

PC Software

CA-S40

PC Software CA-S40	26
Overview	27
System environment	28
Operating requirements.....	28
Instruments controlled	28
Language.....	28
Setup	28
Major functions	29
Operation flow	30
Notes on measurement.....	31
Operation Guide	32
Preparing and starting the software.....	33
Measurement.....	34
Measurement condition settings.....	46
User calibration and ND user correction	54
Data processor data.....	60
Appendix.....	62
Troubleshooting	63
Error message	64
Caution	65
Instruction	68
Information.....	70

PC Software CA-S40



Safety Precautions

Before using the software, please read this manual as well as the instruction manuals of your instrument and personal computer (PC) carefully to ensure safe and correct use.

Introduction

PC Software CA-S40 For Color Analyzers is software that loads and saves measurements and data on a computer connected with the probe or data processor of Display Color Analyzer CA-527 or the CA-410 series via a USB cable. Please note that this manual assumes that the reader is familiar with the basic operations of Windows.

Software License Agreement

The terms of the license agreement for this software are provided in the [Software License Agreement] dialog box displayed during the installation process. This software can be used only if you agree to all the terms of the agreement. KONICA MINOLTA holds the copyrights to the CA-527 and CA-410 USB drivers and this manual.

Notes on Use

- This software is application software for use with Windows 10, Windows 11, macOS Monterey, and macOS Ventura. Please note that this software does not include any OS.
- One of the above OS must be installed on the PC in order to use this software.
- To connect the CA-527 or CA-410 series probe or data processor to a PC, you need the dedicated USB driver.
- This software can only control probes or data processors of the CA-527 or CA-410 series connected by USB. It is not possible to control the probe or data processor of the CA-527 or CA-410 series connected by anything other than USB with this software. It does not support the CA-210 or CA-310 series.
- Make sure that the connector is oriented correctly and connected securely.
- Do not touch or otherwise dirty the terminal portion of the connector or subject the terminals to unreasonable force.
- Use a cable with a suitable length. Putting tension on the cable may cause connection failure or wire breakage.
- Disconnect the connection cable only by holding the plug or the connector. Also, do not pull the cable itself or bend it with unreasonable force.

Every effort has been made in the preparation of this product to ensure the accuracy of its contents. However, should you have any questions or find any errors, please contact your retailer or a KONICA MINOLTA-authorized service facility.

About this manual

The screen capture shots in this manual are examples and may be slightly different from actual screen images. Windows screens are shown in most cases. Menu items, button names, etc. and their respective functions are the same under macOS even if their position on the screen is slightly different.

Overview

System environment.....	28
Operating requirements.....	28
Instruments controlled.....	28
Language.....	28
Setup	28
1. Installing the software (Windows)	28
2. Uninstalling the software (Windows).....	28
3. Installing the software (macOS)	28
4. Uninstalling the software (macOS)	28
Major functions	29
Operation flow.....	30
Notes on measurement	31
1. Notes on hardware operation.....	31

System environment

Operating requirements

OS	Windows® 10 Pro 64bit Windows® 11 Pro macOS® Monterey macOS® Ventura
	<ul style="list-style-type: none">The PC's system configuration must be either that recommended for the above OS or have the following specifications, whichever is higher.
PC	Computer equipped with Intel Core i series, or equivalent or higher processor Computer equipped with an Apple Silicon M1 chip, or equivalent or higher processor (Apple silicon native support)
RAM	4 GB or more
Hard disk	More than 500 MB of available space
Display resolution	1440 x 900 or higher, 16-bit color or higher
Other	USB 2.0 or above required to connect the instrument

Instruments controlled

CA-410 data processor:	CA-DP40
CA-410 probe:	CA-P427 / P427H / P410 / P410H / MP410 / MP410H / VP427 / VP427A / VP410 / VP410A / P427C / P410C / VP402 / VP404 / VP410T
Display color analyzer:	CA-527

Language

Display language	English
-------------------------	---------

Setup

1. Installing the software (Windows)

Double-click [setup.exe] in the Windows folder where the file was downloaded. Proceed as instructed on the screen. When you agree to the license agreement, the installation process starts and the following folders are created under the [Program Files (x86)] folder. The program and manual are installed, and the CA-S40 startup menu is registered in the Start menu.
[Program Files (x86)] – [KONICA MINOLTA] – [CA-S40]

2. Uninstalling the software (Windows)

Open [Control Panel] - [Uninstall a program], select CA-S40 from the list, and double-click it or click [Uninstall].

3. Installing the software (macOS)

Double-click [setup.pkg] in the Mac folder where the file was downloaded. Proceed as instructed on the screen. When you agree to the license agreement, the installation process starts and the following folders are created under the [Application] folder. The program and manual are installed, and the CA-S40 startup menu is registered in the Launchpad.
[Application] – [KONICA MINOLTA] – [CA-S40]

4. Uninstalling the software (macOS)

Right-click the CA-S40 application and click [Move to Trash].

Major functions

Display	(Color)	Lv, x, y, Lv, u', v', Lv, Tcp, duv, X, Y, Z, Lv, λd, and Pe values, chromaticity diagram, and trend graph
	(JEITA/VESA)	Flicker value (dB); frequency and trend graph; spectral intensity value and graph; and waveform graph
	(FMA)	Flicker value (%) and trend graph
	(Waveform)	Flicker value MAX (dB) and frequency; waveform graph; and power spectrum graph
	(VRR)	Flicker value (%) and VRR flicker trend graph

About displayed values

- Although the CA-S40 offers a higher calculation accuracy through internal calculations using more decimal places than found in the displayed values, some calculations, such as rounding, and those during color space conversion may result in a different minimum decimal place from the output of the instrument by one digit. In addition, plotted positions may also differ from those obtained from the displayed values for the same reason.

Instrument control	Single measurement Continuous measurement Interval measurement Color and FMA Number of measurements: 1 to 4,000 times/Measurement interval: 0 to 7,259 sec Number of measurements: 4,001 to 40,000 times/Measurement interval: 1 to 7,259 sec JEITA/VESA and Waveform Number of measurements: 1 to 4,000 times/Measurement interval: 0 to 7,259 sec VRR Number of measurements: 1 to 100 times/Measurement interval: 0 to 7,259 sec Instrument settings Retrieval of data stored in the instrument User calibration Data processors cannot be connected when using ver. 1.1 or earlier of the CA-S40 for macOS.
Target	Writing of a target to the instrument
Data list	Listing of measurement data Edit (delete, copy)
External input/output	Saving in text/CSV format, copying lists to the clipboard

Operation flow

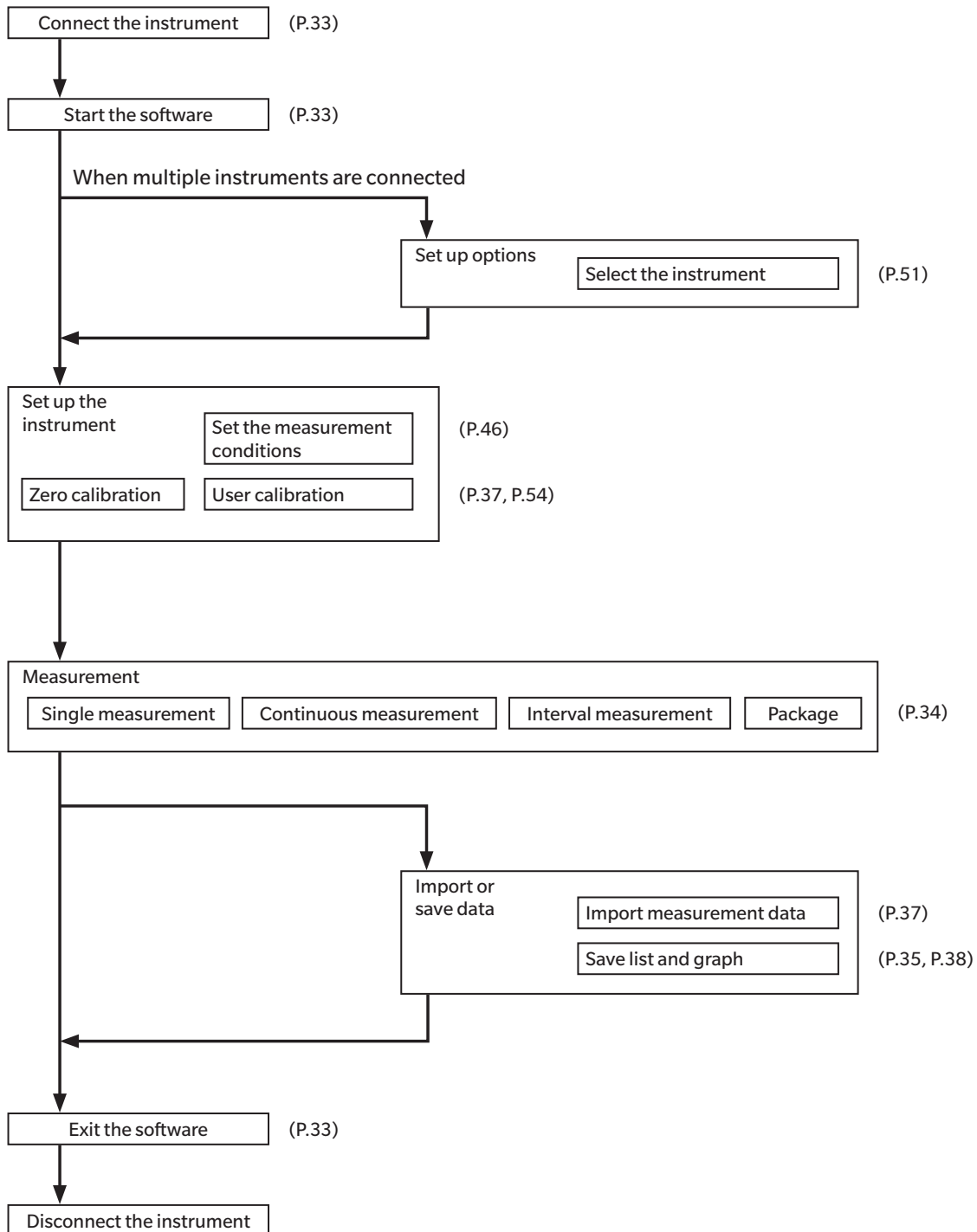

Notes on measurement

1. Notes on hardware operation

- Use the USB cable to connect the instrument. This software can only control probes or data processors of the CA-527 or CA-410 series connected by USB. It is not possible to control the probe or data processor of the CA-527 or CA-410 series connected by anything other than USB with this software. Also, the CA-210/310 series can not be used with this software.
- The CA-VP410A advanced high-sensitivity probe, the CA-VP402 and CA-VP404 small spot probes, and the CA-527 have a large aperture angle, which creates a higher dependence on panel directivity. When measuring panels with high directivity, run user calibration and use the probe without rotating it from the calibrated position.

Operation Guide

Preparing and starting the software	33
1. Connect the instrument and start the software.....	33
Measurement	34
1. Chromaticity measurement	34
1-1. Screen layout	34
1-2. Measurement type	36
1-3. Data display	36
1-4. Color display window	36
2. Common operations	37
3. Individual functions	37
3-1. Gamma measurement (only for chromaticity measurement)	38
4. Flicker measurement (JEITA/VESA)	39
5. Flicker measurement (FMA)	40
6. Waveform measurement.....	41
7. VRR flicker measurement * Only functions when the CA-527 is connected.....	43
Measurement condition settings	46
1. Measurement condition settings <Setting> tab	46
1-1. Measurement mode settings [Mode tab - Mode Settings]	47
1-2. Calibration channel selection [Mode tab - Memory Info.]	48
1-3. JEITA/VESA frequency characteristics settings [Weighting Factor tab].....	48
1-4. Frequency search [SYNC Assist tab - Settings].....	50
2. Option settings <Info> tab	51
2-1. Selecting the date display format and luminance unit	51
2-2. Instrument selection CA Info.	51
2-3. Switching between data processor and probe	52
3. Command communication <Command> tab.....	53
User calibration and ND user correction	54
1. About user calibration and ND user correction <User Cal> tab	54
2. Calibration and correction procedure.....	54
2-1. RGB+W matrix calibration / Single-point calibration.....	55
2-2. ND user correction * Only functions when the CA-527 is connected.....	57
2-3. ID setup	58
2-4. Selecting between user calibration and ND user correction	58
3. Specifying the calibration coefficients <Settings> window.....	59
3-1. Selecting a calibrated channel	59
Data processor data.....	60
1. Handling of stored data	60
2. Handling of Log data.....	61

Preparing and starting the software

1. Connect the instrument and start the software

Connect the instrument

- (1) Connect the instrument (CA probe or data processor) to the PC's USB port. When connecting the instrument, connect it to a USB port that can supply power to the probe. When a message appears prompting for the installation of the USB driver, install the USB driver in the [Driver] folder.
- (2) Check whether the probe's LED indicator blinks.
- (3) Go to [Start menu] - [KONICA MINOLTA] - [CA-S40] and click CA-S40 to start the software.
 - When only one instrument is connected, the measurement screen appears. (See 1-1. Screen layout on P.34)
 - When multiple instruments are connected, the instrument selection screen appears. Select one instrument. (See 2-2. Instrument selection CA Info. on P.51)
 - When no instrument is connected, the error screen appears.
 - When the software starts and the instrument to be used has been chosen, the information of the instrument is displayed in the status bar, indicating that it is ready to be operated from the PC.
 - If a probe that has not been calibrated to its zero point is directly connected to the PC, the internal shutter closes automatically to start zero calibration.
 - When zero calibration is completed, the LED indicator changes from blinking to lighting up steadily.

Notes: The probe operates on USB bus power and requires 5 V and 300 mA. It is recommended that an AC power supply is used for the PC as necessary. It is also recommended that the instrument be disconnected whenever it is not in use.

- (4) Click [Settings] and set the measurement conditions.

Disconnect the instrument

Exit the software and disconnect the instrument from the PC.

Precautions for connecting the instrument

- When the instrument's communication is controlled by another PC or other software, CA-S40 cannot control its communication.
Make sure that the instrument's communication is not controlled by other software. If it is, exit that software as necessary. If the instrument is connected to another PC, disconnect that connection to ensure that it is only connected to the intended controlling PC.
- Connection-related problems (*) may occur and an error message such as "CA device not connected" may be displayed even after an instrument has been connected successfully and proper communication has been established. In this case, restart CA-S40 after checking that the cable is connected and that the instrument (if a data processor is connected) is turned on. Also, the instrument (data processor or probe) may not operate if the operating system on your PC is started (or restarted) after the PC is connected to the instrument using a cable. In this case, exit CA-S40 and, if the instrument is a data processor, turn it off and then on again, and if the instrument is a probe, disconnect and reconnect it to the PC before restarting CA-S40.
 - * Ex. • When CA-S40 is operated after one of the probes is disconnected from the data processor while the CA-S40 is running with one or more probes connected to the data processor
 - When the [ESC] key of the data processor is pressed while CA-S40 is running
- If your PC enters power-saving mode while connected to a measurement instrument (such as a probe or data processor) via USB, communication operations, such as for continuous measurement, may stop. When using the PC in a high communication load situation, such as with continuous measurement, change the power-saving mode settings in the PC control panel to prevent Windows from entering power-saving mode.
- A Firewall alert may be displayed when CA-S40 is started for the first time after installation. In this case, click "Allow access" to grant access because CA-S40 does not connect to an external network.
- If you start the CA-S40 while the data processor startup screen is displayed, connection may not be possible. Please start up the CA-S40 after the data processor starts up and zero calibration is completed.

Measurement

1. Chromaticity measurement

Click the [Color] tab to display the following screen. On this screen, you can measure chromaticity and display the results in the selected color space. User calibration and gamma measurement can also be performed.

1-1. Screen layout

The screenshot displays the 'Color' tab of the software. At the top, there are tabs for 'Color', 'JEITA', 'FMA', 'Waveform', and 'VRR'. Below these are 'Current Data' fields for X, Y, Z, L_{v,xy}, u', v', Tcp, duv, and Δd, Pe. A central table shows measurement data for 10 points (No. 59-68) with columns for X, Y, Z, x, y, L_v, u', v', Tcp, duv, Δd/Δc, Pe, Δt, ErrCode, Sync Mode, Meas Speed, and Averaging Times. To the left is a color space diagram (CIE 1931) with a color bar. Below the table is a graph showing L_v (cd/m²) vs. No. with curves for L_v, x, and y. At the bottom, there are 'Color Window' controls (R: 255, G: 255, B: 255) and a 'Measure' button. Red callouts (1) through (16) point to various UI elements.

- (1) Function selection
Chromaticity measurement (Color), Flicker (JEITA/VESA), Flicker (FMA), Waveform, Flicker VRR
- (2) Instrument information
Information about the instrument that is connected to the PC is displayed.
- (3) Probe information
Probe information is displayed when a data processor is connected. Click here to select the probe.
- (4) Measurement information
This section displays the synchronization mode, measurement speed, calibration mode, and measurement status.
- (5) Help function
The instruction manual, saved on the PC when the software was installed, opens.
- (6) License information
Click here to open a screen that shows the software name and version along with copyright information.
- (7) Individual functions (pop-up)
Zero calibration, settings, data import from data processor, user calibration, gamma measurement
- (8) Measurement start/pause/stop button (Windows: This operation can be performed with the Ctrl + M shortcut key.)
- (9) Color space selection tab
- (10) Latest data display
This area shows the latest data in the color space specified in the color space selection tab above.

(11) Chromaticity diagram

After selecting a graph area,

- Use the mouse wheel to zoom in and zoom out.
- Drag to move the display area.
- Double-click to return to the original scale.
- Right-click on the graph to display the following menu, which allows you to copy the graph to the clipboard or a file.

Right-click → to Clipboard → Background Color: Black
 Background Color: White
 → to File → Background Color: Black
 Background Color: White

* When the chromaticity diagram is enlarged or reduced during a continuous measurement or interval measurement, the plotting may momentarily stop. (Measurement is continuing)

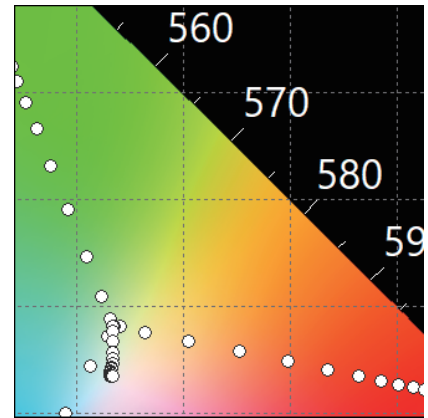

(12) Data display toggling

Toggles between showing both the data list and trend graph, data list only, and trend graph only

(13) Data list (displayed when [List+Trend Graph] or [List] is selected for data display)

- Right-click on the list to display the following menu, which allows you to copy items and selected data to the clipboard or delete selected measurements.

Right-click → Title to Clipboard
 to Clipboard
 Line Clear

- [Δt] in the list shows the temperature change inside the probe from when zero calibration was performed.
- [ErrCode] in the list shows the following statuses: [ErrCode] in the list shows the following statuses: (Refer to page 71 for information on other error codes.)
 - 0: Successfully processed.
 - 1: The currently selected calibration channel uses user calibration data or target data that has been set using a different probe.
 - 2: The temperature inside the probe has changed 6°C or more since zero calibration. It is recommended that zero calibration be performed because an error has occurred due to shift of the zero point.
 - 3: 1 and 2 have occurred simultaneously.
 - 4: The brightness of the measurement target is lower than the measurable range of the instrument.
 - 5: 2 and 3 have occurred simultaneously.
 - 6: 2 and 4 have occurred simultaneously.
 - 7: 1, 2, and 4 have occurred simultaneously.

(14) Trend graph (displayed when [List+Trend Graph] or [Trend Graph] is selected for data display)

Measured values are plotted on the graph in chronological order.

- Right-click on the graph to display the following menu, which allows you to copy the graph to the clipboard or a file.

Right-click → to Clipboard → Background Color: Black
 Background Color: White
 → to File → Background Color: Black → Image Size: 50%
 Image Size: 100%
 Image Size: 150%
 Image Size: 200%
 Background Color: White → Image Size: 50%
 Image Size: 100%
 Image Size: 150%
 Image Size: 200%

(15) Color display window settings

Displays the RGB-specified color window

(16) Data save and clear

Click [Save to CSV] to save the data to a file. Click [Clear] to clear data. The data is saved in CSV format.

Measurement

1-2. Measurement type

1) Select the measurement type.

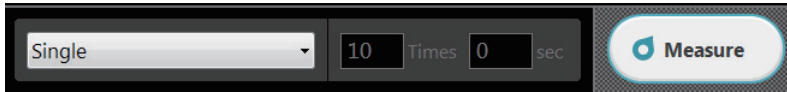

- Single: Single measurement
- Continuous: Continuous measurement (graph scrolls)
 - * Displays up to 100 data sets and deletes data from the oldest.
- Interval: Interval measurement, which performs the specified number of measurements at the specified interval.
- Package: Package measurement minimizes the communications time between PC and data processor and maximizes the measurement function when data processor is used. The times of measurements can be set up to 20.

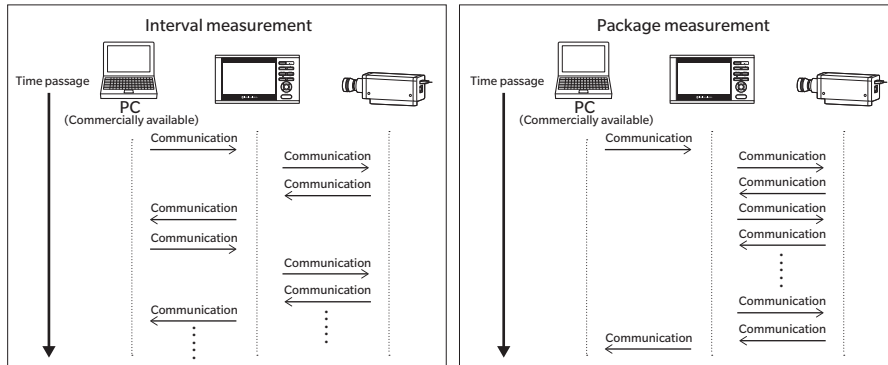

2) Click  to start measurement.

* When using continuous measurement or interval measurement, the button display changes to “Hold”, which you click to pause or stop the measurement.

1-3. Data display

The most recent measurement results are displayed in the [Current Data] field and added to the data list and trend graph. Use the tab in (9) to select the color space to be used for display.

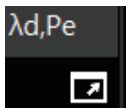
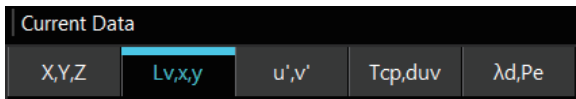

The trend graph is also displayed in the selected color space. Click the pop-up mark as shown on the left to display an enlarged view of “Current Data” in a pop-up window.

1-4. Color display window

You can display the color that you defined using the RGB levels in a pop-up window to be measured using the instrument. You can also change the RGB settings while having this window open.

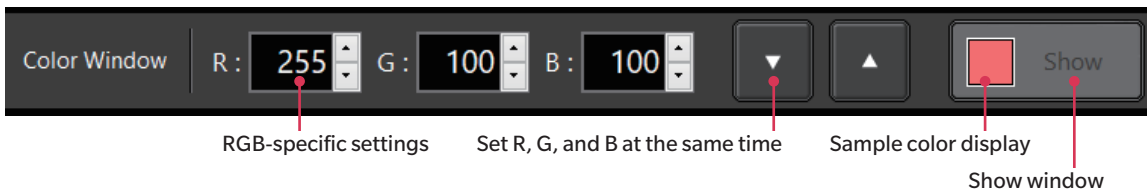

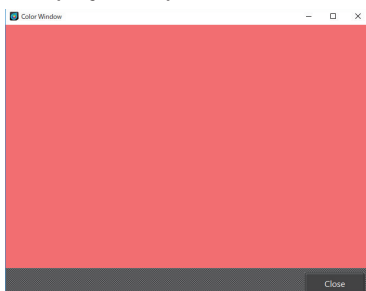

* Display example

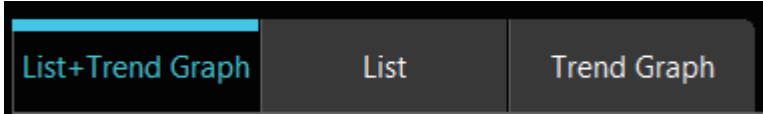

2. Common operations

- 1) On each measurement screen, you can toggle between “Data List” display and “Trend Graph” display.



- 2) Click  to start the measurement with the settings applied.
 3) Click [Save to CSV] to save the data to a file. Click [Clear] to clear data.



* The data is saved in CSV format.

- 4) “Right-click” functions
 Right-click on the data list or graph to display a pop-up menu from which you can copy the data or graph to the clipboard.
 <Example>
 You can also specify the background color (B/W) and size for the graph that you want to save.

3. Individual functions

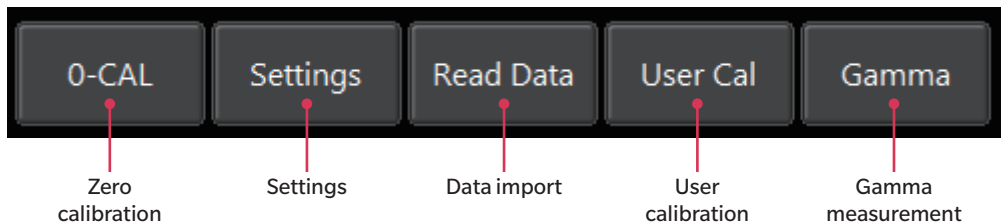

Zero calibration [0-CAL]

- When you click [0-CAL], the shutter inside the probe automatically closes, and zero calibration starts.
- It is recommended that zero calibration be used after start-up or whenever there is a change in ambient temperature or a temperature change inside the instrument due to using it for long periods.

Settings [Settings]

- The pop-up window for setting the measurement conditions appears.
- You can set the measurement speed and the calibrated channel.

Data import [Read Data]

- This function imports the data from the data processor.

User calibration [User Cal] (only for chromaticity measurement)

- The pop-up window for user calibration appears. (See User calibration and ND user correction on P.54)
- The calibration channel (CH00 to CH99) data is read before displaying the pop-up window.

Gamma measurement [Gamma] (only for chromaticity measurement)

- The pop-up window for gamma measurement appears. (See 3-1. Gamma measurement (only for chromaticity measurement) on P.38.)

Measurement

3-1. Gamma measurement (only for chromaticity measurement)

- Click [Gamma] among the individual functions to bring up the pop-up window for gamma measurement. Here, you can measure the color output intensity for each color's input tone.
- When measuring, configure the settings related to the color and tone to be measured.
- Click the measurement start button. The measurement results are displayed in the graph as gamma curve and chromatic difference curve.
- The obtained chromaticity data is displayed on the chromaticity measurement screen and can be saved.

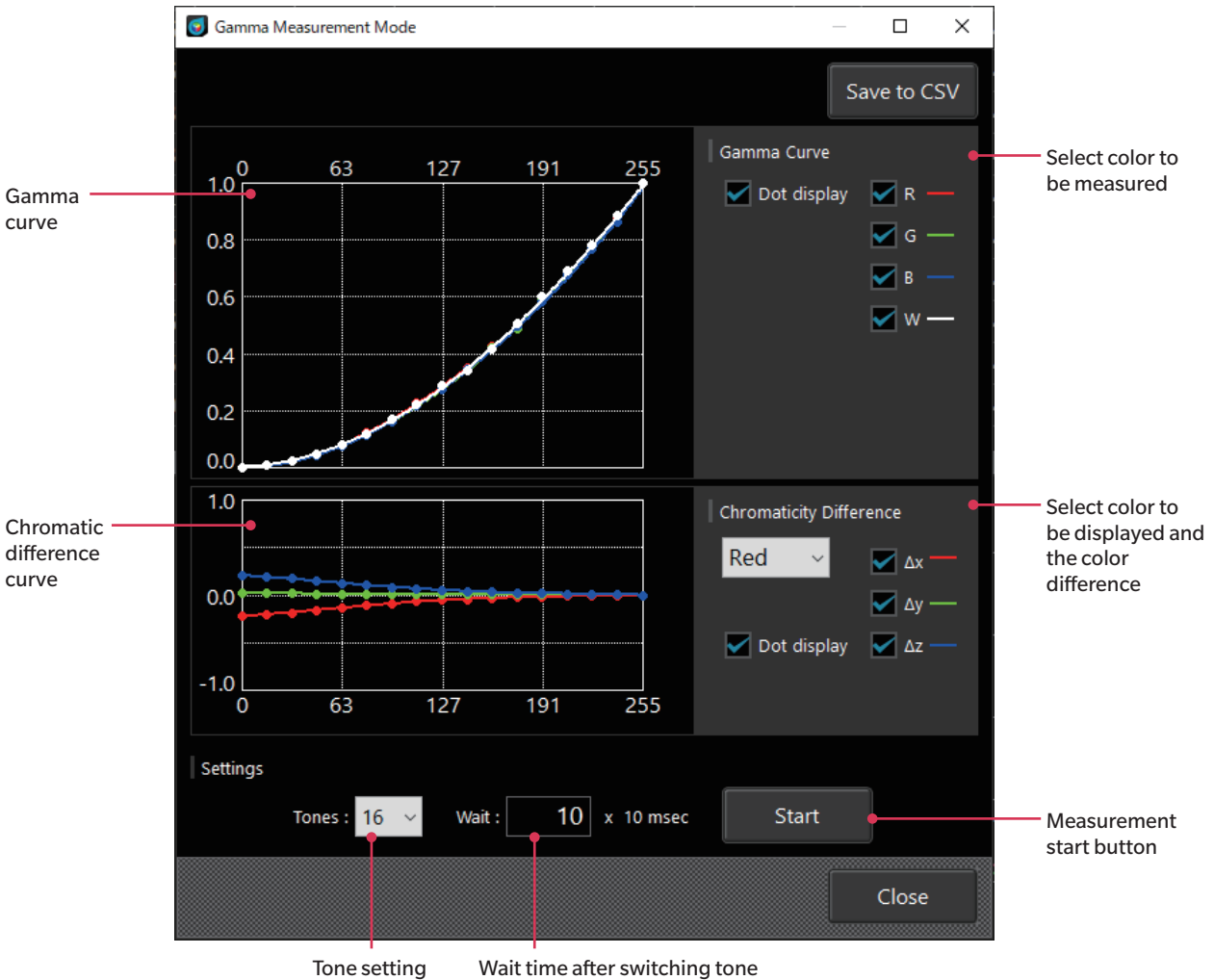

Right-click on the gamma curve or chromatic difference curve (chromatic difference for each tone when the 255 gradation value is set to 0) graph to display the following menu, which allows you to copy the graph and data to the clipboard or a file.

- Right-click on a graph → to Clipboard → Plot data (for Excel)
- Background Color: Black
- Background Color: White
- to File → Plot data (for Excel)
- Background Color: Black → Image Size: 50%
- Image Size: 100%
- Image Size: 150%
- Image Size: 200%
- Background Color: White → Image Size: 50%
- Image Size: 100%
- Image Size: 150%
- Image Size: 200%

4. Flicker measurement (JEITA/VESA)

(Refer to "1. Measurement condition settings <Setting> tab" for information on switching between JEITA and VESA.)

Click the [JEITA] or [VESA] tab to bring up the following screen, where you can set the JEITA/VESA frequency resolution. Click [Measure] to start measurement. The JEITA/VESA flicker measurement values, frequency and frequency characteristics, and waveform are displayed.

Calculation frequency specification

* Only when the CA-527 is connected

Measured value (dB)

Frequency (Hz)

Frequency characteristics

Waveform

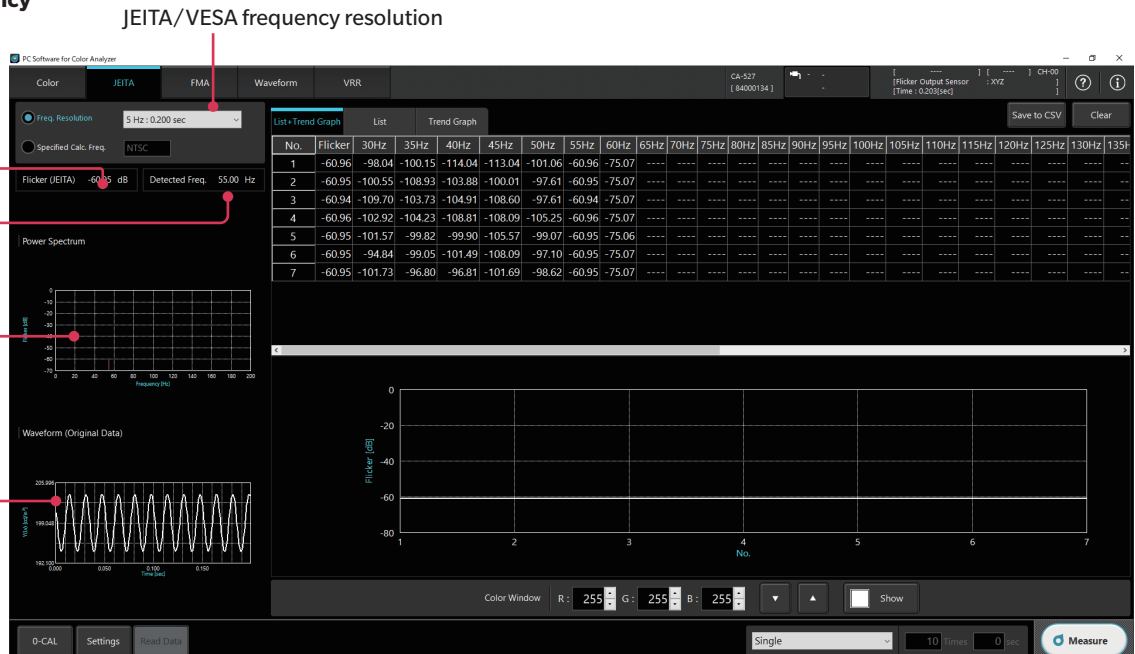

Right-click on the graph to display the following menu, which allows you to copy the graph and data to the clipboard or a file. You can also change the scale on the Waveform graph. The right-click functions accessible by right-clicking over the list or trend graph are the same as those for chromaticity measurement.

Power Spectrum graph

- Right-click → to Clipboard → Background Color: Black
- Background Color: White
- to File → Background Color: Black → Image Size: 50%
- Image Size: 100%
- Image Size: 150%
- Image Size: 200%
- Background Color: White → Image Size: 50%
- Image Size: 100%
- Image Size: 150%
- Image Size: 200%

Waveform graph

- Right-click → Change Scale
- to Clipboard → to Excel
- Background Color: Black
- Background Color: White
- to File → CSV
- Background Color: Black → Image Size: 50%
- Image Size: 100%
- Image Size: 150%
- Image Size: 200%
- Background Color: White → Image Size: 50%
- Image Size: 100%
- Image Size: 150%
- Image Size: 200%

Measurement

Aliasing Noise

During JEITA/VESA flicker measurement, when measuring a light source that includes a harmonic component such as a rectangular wave light source, aliasing noise may occur in the low-frequency range, which can be displayed as the JEITA/VESA flicker value. Peaks that vary greatly on the Power Spectrum graph when changing the JEITA/VESA frequency resolution setting by one step likely are being influenced by aliasing noise.

Set the sampling frequency for JEITA/VESA flicker measurement as follows (typical examples).

JEITA/VESA frequency resolution	Sampling frequency	
	Flicker (CA-310 Mode)*	XYZ (Wide Frequency Mode)*
0.1 Hz	409.6 Hz	1638.4 Hz
0.5 Hz	1024 Hz	1024 Hz
1 Hz	1024 Hz	1024 Hz

* “Flicker (CA-310 Mode)” and “XYZ (Wide Frequency Mode)” are flicker measurement operation mode names for PC Software CA-S40. “XYZ (Wide Frequency Mode)” can only be used when no CA-DP40 data processor is connected.

5. Flicker measurement (FMA)

Click the [FMA] tab to bring up the following screen and click [Measure] to start measurement. The FMA flicker measurement values are displayed.

When performing flicker measurement (FMA), make sure the measurement mode is set correctly (refer to page 47).

To measure waveforms with a vertical synchronization frequency that exceeds 240 Hz (flicker frequency exceeds 120 Hz), set the INT setting frequency of measurement mode to 240 Hz.



Right-click on the list or graph to copy the graph and data to the clipboard or a file. The right-click menu is the same as that for chromaticity measurement.

6. Waveform measurement (Also refer to “1. Measurement condition settings <Setting> tab”)

Click the [Waveform] tab to bring up the following screen where you can set various parameters. Click [Measure] to start measurement. The flicker measurement values and other measurement results will be displayed in a waveform graph and power spectrum graph.

With the CA-410 series probe connected

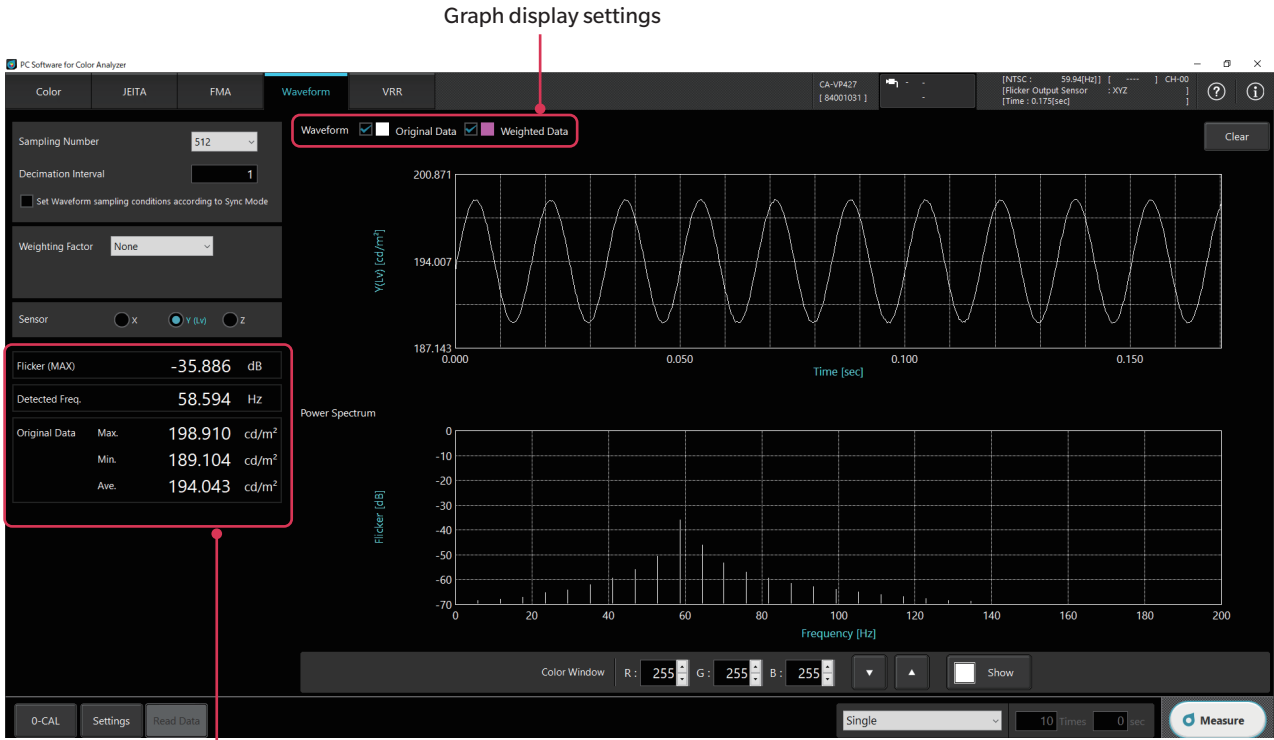

Measurement result

- Set Waveform sampling conditions according to Sync Mode
 - : When checked, sampling will be performed according to the input Sync Mode (refer to page 47). As such, configuration of Sampling Number or Decimation Interval will not be possible.
 - Sampling Number : Sets the number of measurements to perform.
 - Decimation Interval : Sets the number of intervals for measurement.
- The measurement time is defined as follows.
- $$\text{Measurement time} = \text{Flicker measurement speed} \times \text{Sampling number} \times \text{Decimation interval}$$
- The possible range of calculating the flicker value differs depending on the measurement time while adhering to the following.
- (1 / measurement time) to 200 Hz
- Weighting Factor : Sets a filter for the measured value. (NONE/IEC/JEITA(VESA)/ICDM/LowPass/User)
 - No filter will be applied if “None” is selected. The graph will display original data only.
 - When “IEC,” “JEITA (VESA*1),” or “ICDM” is selected, a filter adjusted to the frequency response characteristics of the human eye is used.
 - *1 This varies depending on what is selected with Settings > Flicker Standards.
 - When “LowPass” is selected, the user can set the LowPass filter to between 0 to 1500.
 - When “User” is selected, the user can load a custom filter to be used for measurement from the [Weighting Factor] tab in the [Settings] tab.

The data will be displayed as weighted data with the filter applied. Users can select to display the graph using the check box in the graph display settings.
 - Sensor : Sets the sensor when “XYZ (Wide Frequency Mode)” is selected for the flicker measurement operation mode. (X/Y(Lv)/Z)
 - When “Flicker (CA-310 Mode)” is selected for the operation mode, only sensor Y can be used.
- Measurement results such as flicker measurement values and Power Spectrum graph data are subject to a filter and considered Weighted Data.

Measurement

With the CA-527 connected



- Set Waveform sampling conditions according to Sync Mode
 - : When checked, sampling will be performed according to the input Sync Mode (refer to page 47). As such, configuration of Sampling Number or Sampling Freq. will not be possible.
- Sampling Number : Sets the number of measurements to perform.
- Sampling Freq. : Sets the sampling frequency.
 - When "Flicker (CA-310 Mode)" is selected for the flicker measurement operation mode: 2747.6 to 200000.0 Hz
 - When "XYZ (Wide Frequency Mode)" is selected for the flicker measurement operation mode: 2000.0 to 3000.0 Hz
- Weighting Factor : Sets a filter for the measured value. (NONE/IEC/JEITA (VESA)/ICDM/LowPass/User)
 - No filter will be applied if "None" is selected. The graph will display Original Data only.
 - When "IEC," "JEITA (VESA*1)," or "ICDM" is selected, a filter adjusted to the frequency response characteristics of the human eye is used.
 - *1 This varies depending on what is selected with Settings > Flicker Standards.
 - When "LowPass" is selected, the user can set the LowPass filter to a value between 0 and 1,500.
 - When "User" is selected, the user can load a custom filter to be used for measurement from the [Weighting Factor] tab in the <Setting> tab.

The Data will be displayed as Weighted Data with the filter applied. Users can select to display the graph using the check box in the graph display settings.
- Waveform:
 - You can select the following items for the "Original" waveform (before the application of Weighting Factor) and the "Weighted" waveform (after the application of Weighting Factor) in the Waveform graph.
 - When "Flicker (CA-310 Mode)" is selected for the flicker measurement operation mode
 - Y(Lv)
 - When "XYZ (Wide Frequency Mode)" is selected for the flicker measurement operation mode
 - X
 - Y(Lv)
 - Z
 - X
 - Z

7. VRR flicker measurement (Also refer to “1. Measurement condition settings <Setting> tab”) * Only functions when the CA-527 is connected

Click the [VRR] tab to bring up the following screen where you can set various parameters. Click [Measure] to start measurement. The flicker measured values and other measurement results will be displayed in a VRR flicker trend graph.



The VRR Flicker function can only be used when the CA-527 is connected.

Sampling Freq.: Enter the sampling frequency for VRR Flicker measurements.

The settable range for [Sampling Freq.] varies depending on the flicker measurement operation mode, as shown below.

- Flicker (CA-310 Mode): 2747.6 to 200000.0 Hz
- XYZ (Wide Frequency Mode): 2000.0 to 3000.0 Hz

Measurement Time: Enter the measurement time for VRR Flicker measurements.

The settable range for [Measurement Time] is shown below.

However, the lower limit of [Measurement Time] must be greater than or equal to the value entered for [Window for VRRF].

Flicker measurement operation mode	Sampling frequency setting value [Hz]		Measurement time settable range [sec]	
			Lower limit	Upper limit
Flicker	Min.	2747.6	0.100	109.186
	Max.	200000.0	0.100	1.500
XYZ	Min.	2000.0	0.100	150.000
	Max.	3000.0	0.100	100.000

Window for VRRF: Enter the interval (time) during which to calculate Trend values for VRR Flicker measurements.

The settable range for [Window for VRRF] is shown below.

0.100 to 0.500

Use the three check boxes at the top of the screen to show/hide the trend graphs.

- Original Data
- Weighted Data
- VRRF Trend

Measurement

Right-click on the graph to copy the graph and data to the clipboard or a file.

You can also change the scale on the VRR flicker graph. The right-click functions accessible by right-clicking over the list or trend graph are the same as those for chromaticity measurement.

VRR flicker trend graph

Right-click → Change Scale
to Clipboard → to Excel
Background Color: Black
Background Color: White
to File → CSV
Background Color: Black → Image Size: 50%
Image Size: 100%
Image Size: 150%
Image Size: 200%
Background Color: White → Image Size: 50%
Image Size: 100%
Image Size: 150%
Image Size: 200%

When you select “Change Scale,” the following dialog box appears.

Because there will be two Y axes on the Waveform VRRF Trend graph, adjust the scale for the three axes.

Use Axis to select the axis to adjust. Then, select Auto or Manual to adjust the scale.

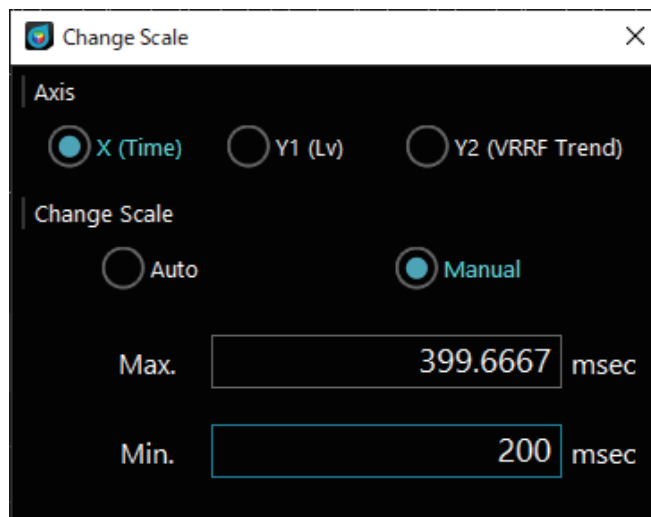

No.	Sampling Freq.	Measurement Time	Window for VRRF	VRR Flicker Trend			Weighted Data			Date	Time
				Max.	Min.	Ave.	Max.	Min.	Ave.		
1	3000.0	1.000	0.150	0.06	0.04	0.05	198.975	198.854	198.911	2023/12/25	20:09:47
2	3000.0	1.000	0.150	0.06	0.04	0.05	198.977	198.863	198.918	2023/12/25	20:09:51
3	3000.0	0.500	0.150	0.05	0.05	0.05	198.978	198.867	198.925	2023/12/25	20:10:03
4	3000.0	0.500	0.100	0.05	0.04	0.05	198.964	198.863	198.914	2023/12/25	20:10:17
5	3000.0	0.500	0.100	0.05	0.04	0.05	198.954	198.849	198.903	2023/12/25	20:10:18
6	3000.0	0.500	0.100	0.06	0.04	0.05	198.961	198.841	198.908	2023/12/25	20:10:21

- No.: Sequential number in the measurement history list
- Sampling Freq.: Sampling frequency calculated from the measurement time
- Measurement Time: Time specified with the [Measurement Time] field
- Window for VRRF: VRRF Trend calculation interval (time) specified with the [Window for VRRF] field
- VRR Flicker Trend:
 - Max.: VRRF Trend maximum
 - Min.: VRRF Trend minimum
 - Ave.: VRRF Trend average
- Weighted Data:
 - Max.: Maximum luminance (Lv) after Weighting Factor application
 - Min.: Minimum luminance (Lv) after Weighting Factor application
 - Ave.: Average luminance (Lv) after Weighting Factor application
- Date: Date at the end of measurement
- Time: Time at the end of measurement

Up to 100 measurements can be displayed in the measurement history list.

- Single Measure / Interval Measure

When there are more than 100 measurements, data is deleted from the oldest measurements.

You can click [Save to CSV] to save all the data in the measurement history list to a file in CSV format.

When a CA-410 series probe is connected, the VRR Flicker function cannot be used, so related functions are grayed out.



The following parts are grayed out.

- Sampling Freq.
- Measurement Time
- Window for VRRF
- [Original Data] check box
- [Weighted Data] check box
- [VRRF Trend] check box
- [Measure] button

Click [Settings] among the individual functions to bring up the following pop-up window for setting the measurement conditions and optional items.

1. Measurement condition settings <Setting> tab

Settings

Setting Info Command CA-527 [84000134]

Mode Weighting Factor Sync Assist

Mode Settings

Sync Mode: NTSC
 PAL
 UNIV
 INT 40.00 Hz [Scan]
 EXT 3.3 V
 MANUAL 4.0 msec

Measurement Speed: SLOW
 FAST
 LTD.AUTO
 AUTO

Integration Time: Single-Frame
 Double-Frame

Averaging Times: 1

Flicker Standards: JEITA

Flicker Output Sensor: Flicker (CA-310 Mode)
 XYZ (Wide Frequency Mode)

Memory Info.

CH ID: CH00 <CH00>

Target x	Target y	Target Lv [cd/m ²]
0.31270	0.32900	100.000

Shutter: (valid when using XYZ sensor)
 Open
 Close

OK Cancel Apply

Measurement mode

Calibration channel information

1-1. Measurement mode settings [Mode tab - Mode Settings]

○ Sync Mode : Select the mode for synchronized measurement. (NTSC/PAL/UNIV/INT/EXT/MANUAL)

Measurement synchronization mode	Description of mode	Integration time		Vertical scanning frequency	Vertical synchronization signal input
		Single-Frame	Double-Frame		
NTSC	Mode for measuring NTSC displays	16.7 ms	33.3 ms	59.94 Hz	Not required
PAL	Mode for measuring PAL and SECAM displays	20.0 ms	40.0 ms	50 Hz	Not required
EXT	Mode for measuring while synchronizing with the display's vertical synchronization signal input	1 vertical scanning period	(1 vertical scanning period) x 2	0.50 to 240.00 Hz*1	Required
UNIV	Mode that allows measurement with an integration time of 100 ms Available when the display's vertical scanning frequency is unknown or when input of the vertical synchronization signal is not possible. (When the light source fluctuates sharply due to PWM control, etc., fluctuations in the measured values may increase.)	—	100 ms	—	Not required
INT	When the display's vertical synchronization signal is known, set that information so that it can be used for measurement.	Set vertical scanning period	(Set vertical scanning period) x 2	Settable range (Flicker mode for FMA: 0.50 to 130.00 Hz) Use the [Scan] button*2 to measure frequency, or use the [SYNC Assist] tab to search for the optimum frequency.	Not required
MANUAL	Mode that allows you to specify the integration time	—	Settable range 4.0 to 4000.0 ms (For FMA, 7.7 to 4000.0 ms)	—	Not required

*1 For waveform measurement: 0.50 to 400.00 Hz. The frequency varies for FMA depending on the operation mode.
Flicker mode: 0.50 to 130.00 Hz, XYZ mode: 0.50 to 400.00 Hz.

*2 The [Scan] button is enabled when INT is selected.

The Scan function measures the display to detect the light emission frequency (10.00 to 240.00 Hz). When the [Scan] button is pressed, a white window and a dialog confirming the start of measurement are displayed. Set the probe to a position where the white window can be measured, and then press the [Yes] button.

Note: The probe firmware version must be Ver. 1.3 or higher.

Note: This function cannot be used when using a data processor.

○ Measurement Speed : Select the measurement speed. (SLOW/FAST/LTD.AUTO/AUTO)

- Selecting FAST can shorten measurement time, but may compromise measurement repeatability for low-luminance measurements.
- Selecting SLOW repeats FAST measurements several times to ensure measurement with high repeatability.
- When AUTO is selected, measurements are automatically selected between SLOW, FAST, and setting with a further longer integration time depending on the luminance level.
- When LTD.AUTO is selected, measurements are automatically selected between SLOW and FAST depending on the luminance level.

Notes: For the first measurement or when the brightness of the measurement target changes from the that in the previous measurement, the switching of ranges may result in longer measurement time.

○ Averaging Times : Set the number of measurements taken to average for obtaining a single measurement value. (1 to 20)

○ Flicker Output Sensor : Select the operation mode for flicker measurement.

(Flicker (CA-310 Mode) / XYZ (Wide Frequency Mode))

- "Flicker (CA-310 Mode)" is the same operation mode as flicker measurement (JEITA/VESA screen, Waveform screen) in conventional CA-310 and CA-S40 (up to Ver. 1.2) products. In this mode, the measurement range for the measurement target (flicker frequency) is 0.25 to 65 Hz, and the flicker measurement speed is 33.333 μ s. This mode is selectable only when probes other than CA-VP427A, CA-VP410A, CA-VP404, CA-VP402 or CA-VP410T are connected.
- In "XYZ (Wide Frequency Mode)" operation mode, the measurement range for the measurement target (flicker frequency) is 0.25 to 200 Hz. The flicker measurement speed is 333.333 μ s. This mode can be selected when any probe is connected.

○ Integration Time : Select the shortest measurement time for synchronized measurement.

- When Single-Frame is selected, measurement takes half the normal amount of time (Double-Frame).
- When Double-Frame is selected, measurement takes the normal amount of time.

Note: The probe firmware version must be Ver. 1.2 or higher.

Note: Integration time is fixed to Double-Frame when using a data processor.

○ Flicker Standards : Select either JEITA or VESA for the flicker measurement standard.

Measurement condition settings

○ Shutter:

You can select Close mode to reduce residue during measurement when using the CA-527. One example application is prioritizing low-luminance performance. Use Close mode when it is necessary to measure immediately after changing from close to the upper limit of the guaranteed-accuracy luminance range to close to the lower limit of this range. The Close mode setting is not recorded. The next time the CA-S40 starts, it will return to Shutter Open mode.

1-2. Calibration channel selection [Mode tab - Memory Info.]

- CH ID : Select a calibrated channel. Measurement values are corrected using the calibration coefficient of the selected calibration channel. If you do not need such correction, select CH00. The target saved to the selected calibration channel is displayed.

1-3. JEITA/VESA frequency characteristics settings [Weighting Factor tab]

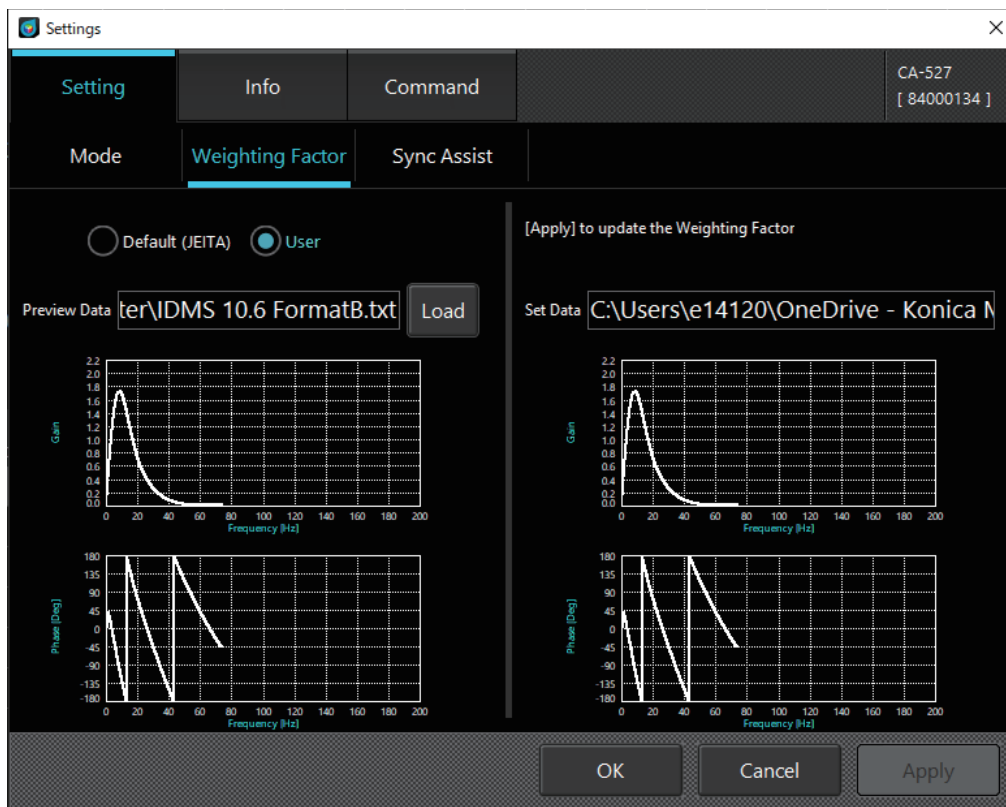

○ Weighting Factor: Specify the frequency characteristics for JEITA/VESA flicker measurements.

- When "Default (JEITA/VESA)" is selected, a CA-310-compatible filter compliant with JEITA/VESA standards and adjusted to the human eye is used.
- When "User" is selected, the filter created by the user is used. In the text file (.txt) for the filter, include the starting frequency, end frequency, frequency pitch, and number of data sets on the first line. Then, include the frequency values on the following lines in tab-delimited format. You can use the way that you write the frequencies to select from three formats. Click [Load] to navigate to the reference folder and load the created filter file to draw the graph. This user-created filter will be applied to flicker measurement (JEITA/VESA) results and Waveform measurement results when "User" is selected under Weighting Factor. Note that 0 Hz (DC component) will be calculated as 1.0.

Click [OK] to confirm the settings or click [Cancel] to cancel the edit and close the pop-up.

* For reference, files with the frequency response characteristics of the human eye ([IEC 62341-6-3.txt], [IDMS 10.6 FormatA.txt], and [IDMS 10.6 FormatB.txt]) are stored in [KONICA MINOLTA] – [CA-S40] – [Template].
The tables from IEC 62341-6-32017/COR1:2019 and ICDM Information Display Measurements Standard Version 1.2.

[Format A]

In this format, each frequency has a gain value and a phase value.

Values can be written in the normal fixed decimal point format (example: 0.1755) or the exponential format (example: 1.755E-01).

Text file content:	Example of text file content: Fixed decimal point format	Upper/lower limits:
<pre><Starting frequency> <End frequency> <Frequency pitch> <Number of data sets> <Frequency> <Gain> <Phase></pre>	<pre>0.01 75 0.01 7500 0.01 0.1755 0.8862 0.02 0.1756 1.7716 0.03 0.1758 2.6554 0.04 0.1761 3.5366 0.05 0.1763 4.4146</pre>	<pre>Starting frequency: 0.01 - 999.99 Hz End frequency: 0.02 - 1000.00 Hz Frequency pitch: 0.01 - 10.00 Hz Number of data sets: 2 - 100000 Gain: 0.0000 - 10.0000 Phase: -180° - +180°</pre>

[Format B]

In this format, the gain and phase values are represented as complex numbers. For imaginary units, “i” or “j” can be used. The complex numbers are converted to gain and phase, and then Weighting Factor is applied.

The same as format A, values can be written in the fixed decimal point format or the exponential format.

Text file content:	Example of text file content: Fixed decimal point format	Upper/lower limits:
<pre><Starting frequency> <End frequency> <Frequency pitch> <Number of data sets> <Frequency> <Complex number></pre>	<pre>0.01 75 0.01 7500 0.01 0.1754778629+0.002714457i 0.02 0.1755134512+0.0054287557i 0.03 0.1755727632+0.0081427376i 0.04 0.1756557966+0.0108562444i 0.05 0.1757625478+0.0135691177i</pre>	<pre>Starting frequency: 0.01 - 999.99 Hz End frequency: 0.02 - 1000.00 Hz Frequency pitch: 0.01 - 10.00 Hz Number of data sets: 2 - 100000 Complex number: $0 \leq \sqrt{a^2 + b^2} \leq 10$ when complex numbers are represented in the format a + bi</pre>

[Old format (compatible with Ver. 1.8)]

Only gain is handled for each frequency. The phase is set to 0 for all frequencies.

Text file content:	Example of text file content:	Upper/lower limits:
<pre><Starting frequency> <End frequency> <Frequency pitch> <Number of data sets> <Frequency> <Gain></pre>	<pre>0.01 65 0.01 6500 0.01 1.0 0.02 1.0 65 0.0</pre>	<pre>Starting frequency: 0.01 - 999.99 Hz End frequency: 0.02 - 1000.00 Hz Frequency pitch: 0.01 - 10.00 Hz Number of data sets: 2 - 100000 Gain: 0.0000 - 10.0000</pre>

Measurement condition settings

1-4. Frequency search [SYNC Assist tab – Settings]

If “INT” is selected as the sync mode, and if the user has some idea of vertical synchronization frequency of the display (measurement target), using the following procedure to set the internal synchronization frequency correctly up to the second decimal place makes it possible to perform measurement with good repeatability.



- (1) Set the number of measurements to perform for Sampling Number.
- (2) Set the known vertical synchronization frequency for the display (measurement target) for Frequency, and click [Measure]. During measurement, the standard deviation $2\sigma_{Lv}$ is calculated from the measured values obtained from the number of measurements for Sampling Number, and the results are plotted on the graph. The most recent $2\sigma_{Lv}$ value is also displayed as the Current Value.
It is possible to change Frequency during measurement.
- (3) While changing Frequency, watch the graph to determine which frequency shows the smallest $2\sigma_{Lv}$ value.
- (4) When the optimum frequency has been found, stop measurement and return to the [Mode] tab. The obtained vertical synchronization frequency will be displayed in the [INT] column of [Sync Mode].
If [Measurement Speed] in the [Mode] tab has been changed, it will be necessary to obtain the optimum frequency again in the [SYNC Assist] tab after confirming the setting by clicking [OK].

2. Option settings <Info> tab

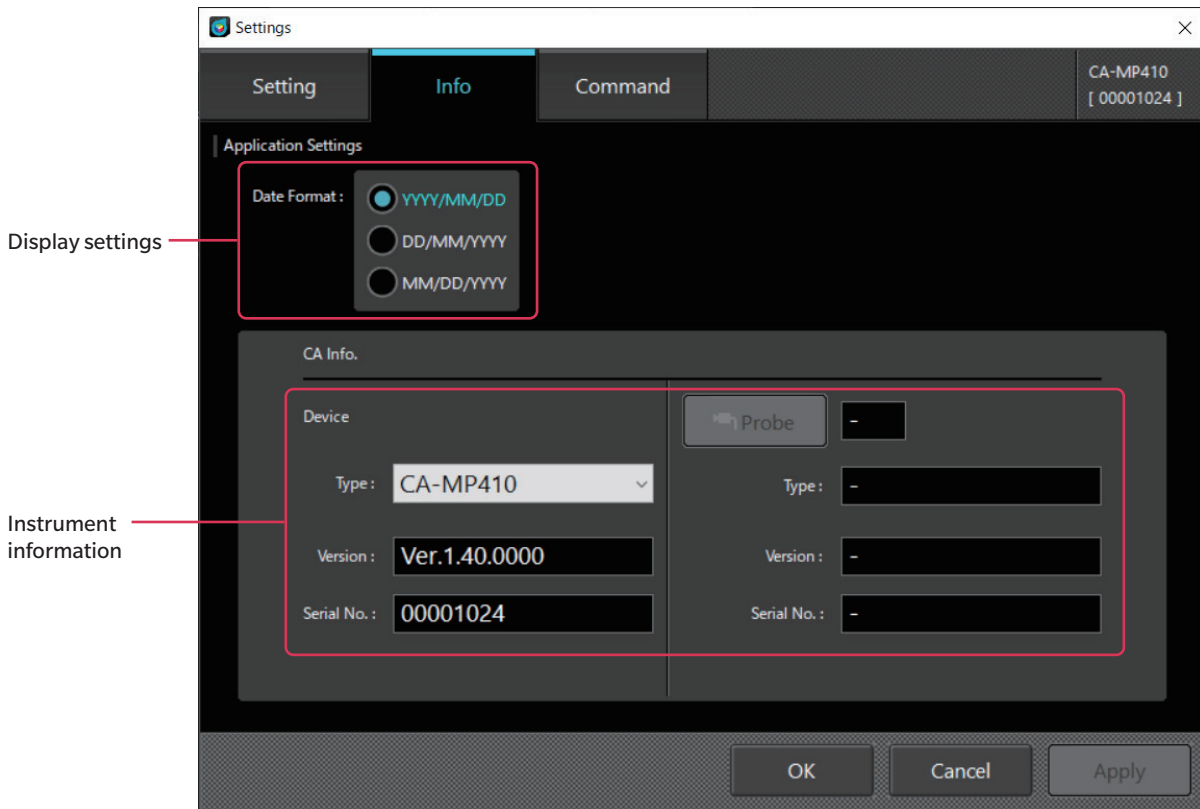

2-1. Selecting the date display format and luminance unit

Application Settings

- Date Format : Select a date display format.
- Luminance Unit : Select a luminance unit.

If the selection of [Luminance Unit] is not displayed on the screen, exit the software, and restart the software after adding “/u” as the startup option for the software execution file “CA-S40.”

2-2. Instrument selection CA Info.

This screen appears first when the software is started with multiple instruments connected to the PC. Information about the selected instrument is displayed.

Device:

Among the instruments connected to the PC, select the one to be used in the drop-down menu. Information about the selected instrument (firmware version and serial number) is displayed.

If a data processor is selected as the instrument to be used, then also select the probe connected to the data processor in the [Probe] field on the right.

Information about the selected probe (firmware version and serial number) is displayed.

- Type : Displays the type of instrument connected.
- Version : Displays the firmware version of the selected instrument.
- Serial No. : Displays the serial number of the selected instrument.

Click [OK] to confirm the settings or click [Cancel] to cancel the edit and close the pop-up.

Measurement condition settings

2-3. Switching between data processor and probe

How to switch from "Type" on the Settings-Info screen

- (1) Select the data processor in "CA Info" - "Device" - "Type".
- (2) Click the [Probe] button on the "CA Info". (Select the device connected to the data processor.)
- (3) Select an area that is not any probe on the Select Probe screen and click [OK] to switch to the data processor.
Select the probe you want to connect to on the Select Probe screen and click [OK] to switch to the probe.

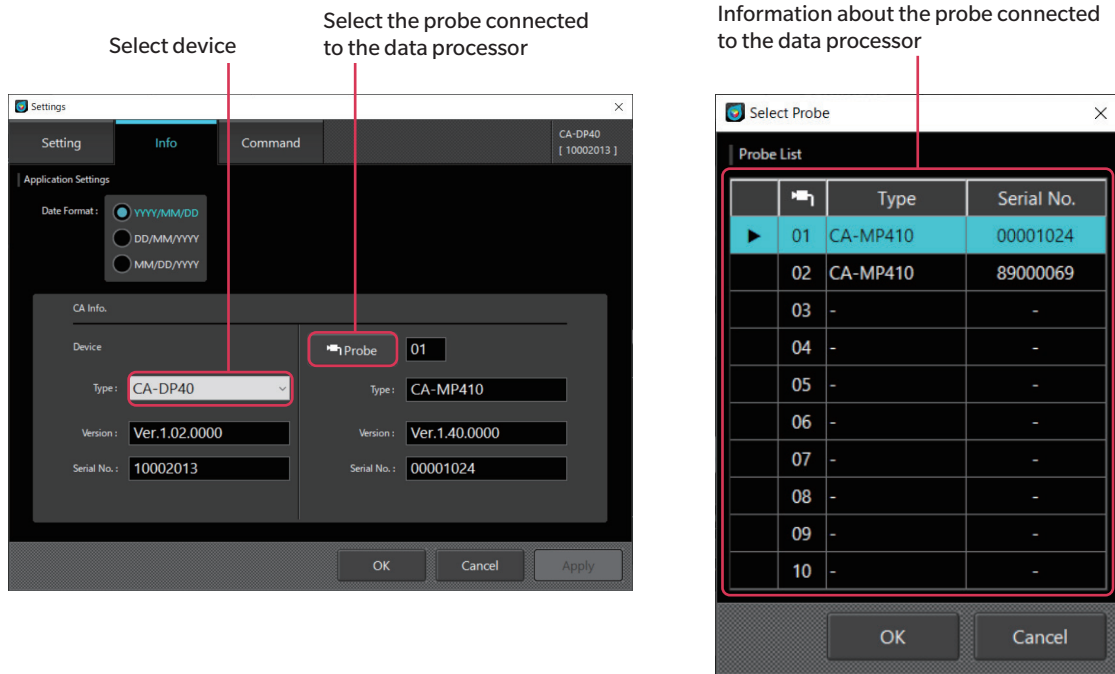

How to switch on the status bar

- (1) Select the measuring device switching button on the status bar.
- (2) Select an area that is not any probe on the Select Probe screen and click [OK] to switch to the data processor.
Select the probe you want to connect to on the Select Probe screen and click [OK] to switch to the probe.

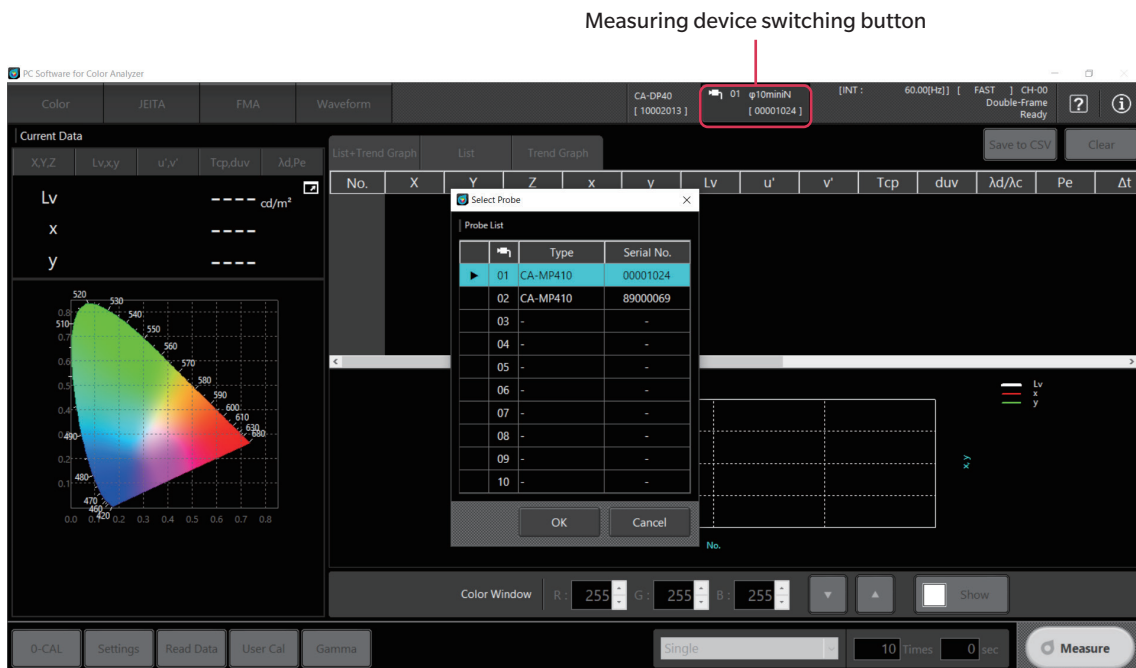

3. Command communication <Command> tab

The user can check the operations of communication commands when developing original software.
The specifications of communication commands are available for download from the following webpage:
<https://www.konicaminolta.com/instruments/download/>

Memo / • The communication specifications vary between the CA-410 series and the CA-527. Download the communication specifications for the instrument you are using.

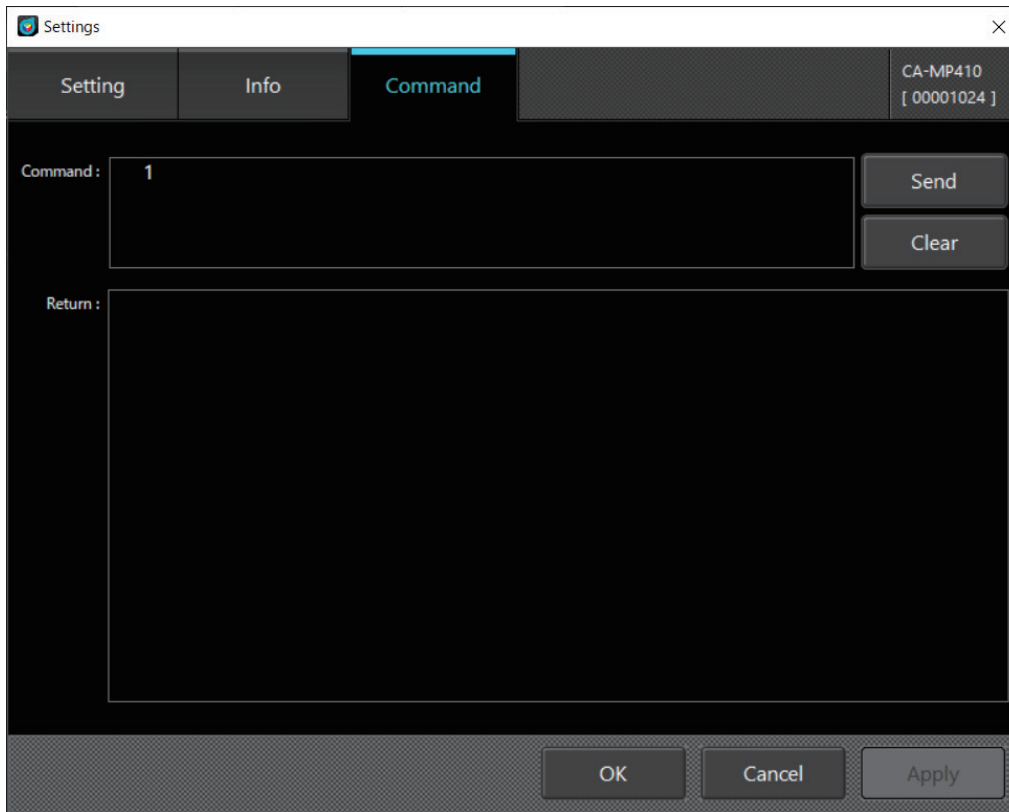

○ Command : Enter a command to be sent and click [Send] to send it to the instrument.

○ Return : Displays the command reception result from the instrument.

* This function is used for checking command communication operation. Restart CA-S40 after executing command communication to update the CA-S40 settings to reflect the changes from command communication.

User calibration and ND user correction

1. About user calibration and ND user correction <User Cal> tab

[User calibration]

- User calibration allows users to set their own correction coefficients to the calibration channel of the probe by measuring any colors and setting calibration values to the probe. After setting, the values corrected with the specified correction coefficients can be displayed and output for every measurement.

[ND user correction (CA-527 function)]

- The CA-527 has a wide guaranteed-accuracy luminance range and, to enable this range, is equipped with an ND filter. If there is a difference between the characteristics of the light source you want to measure and Konica Minolta's standard light source, inserting and removing the ND filter may lead to subtle misalignment in the linearity.
- ND user correction sets to the calibration channel of the probe coefficients for correcting subtle misalignment in the linearity caused by inserting and removing the ND filter for the light source you want to measure.

Memo

- When running ND user correction and user calibration separately, be sure to run ND user correction first.
- As user calibration with a CA-410 series probe, you can select single-point calibration or RGB+W matrix calibration.
- On the CA-527, you can perform ND user correction by selecting the [with ND Calibration] check box before performing single-point calibration or RGB+W matrix calibration.
- User calibration and ND user correction can be performed for every calibration channel (except for CH00).
- User calibration and ND user correction cannot be performed for CH00 because it is calibrated in accordance with the Konica Minolta calibration standard.
- You can use user calibration to apply the following corrections to measurements based on the specified correction coefficients.
 - Correct the difference in the reading due to the inconsistencies in the spectral response of the light-receiving element of the probe.
 - Correct the difference in the readings between probes used simultaneously.

2. Calibration and correction procedure

- Click the [User Cal] button on the chromaticity measurement screen to open the [User Calibration Mode] dialog and the [Color Window].
- The calibration channel (CH00 to CH99) data is read from the probe and displayed in the dialog.
- As calibration channel data, the ID, calibration probe, calibration mode, ND user correction mode, Lv, x, y, calibration date/time, and comments are displayed.
- A user calibration coefficient is written to the specified calibration channel. If a coefficient is already written in that calibration channel, it is overwritten.
- The target value used is written to a calibration channel as its target. If target data is already written in that calibration channel, it is overwritten.
- Performing zero calibration by clicking the [0-CAL] button is recommended before running a calibration.
- Data written to the calibration channel can be saved and read as a file using the [Load] and [Save] buttons next to the selected channel display.

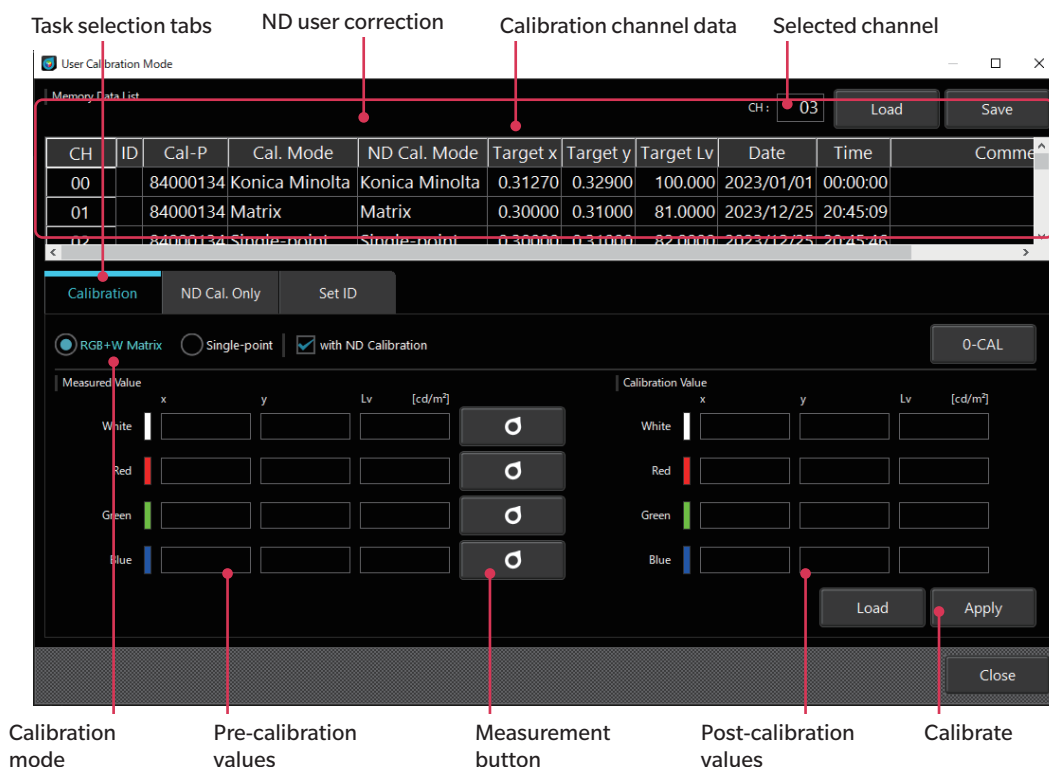

2-1. RGB+W matrix calibration / Single-point calibration

- (1) Select the [Calibration] tab.
- (2) Select the calibration channel to be calibrated. (CH01 to CH99)
 - Click over the calibration channel data.
- (3) Select [RGB+W Matrix] or [Single-point] as the calibration mode.
 - When [RGB+W Matrix] is selected, White, Red, Green, and Blue are measured (in no particular order). When [Single-point] is selected, only White is measured.
- (4) When the measurement button to the right of each color in the [Measured Value] area is clicked, the [Color Window] changes to the target color, and a dialog confirming the start of measurement is displayed.



- (5) Place the probe on the color display dialog and press the [OK] button.

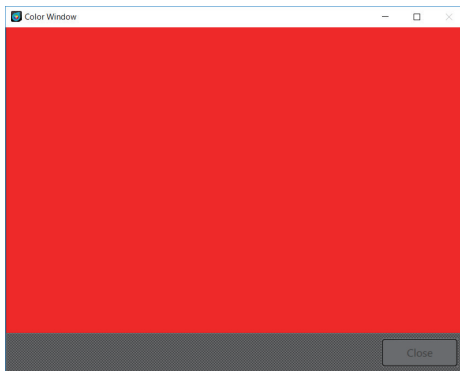
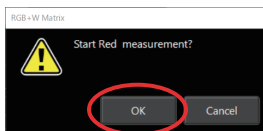

- (6) Measurement is performed, and the measured value is displayed in the [Measured Value] area.

Measured value

CH	ID	Cal-P	Cal. Mode	ND Cal. Mode	Target x	Target y	Target Lv	Date	Time	Comme
00	84000134	Konica Minolta	Konica Minolta	Konica Minolta	0.31270	0.32900	100.000	2023/01/01	00:00:00	
01	84000134	Matrix	Matrix	Matrix	0.30000	0.31000	81.0000	2023/12/25	20:45:09	
02	84000134	Single-point	Single-point	Single-point	0.30000	0.31000	82.0000	2023/12/25	20:45:46	

Measured Value	x	y	Lv [cd/m²]
White			
Red	0.45253	0.34636	22.2745
Green			
Blue			

User calibration and ND user correction

- (7) Enter the target values to correct and display in the [Calibration Value] field.
To load target values saved to a tab-delimited text file, click the [Load] button.

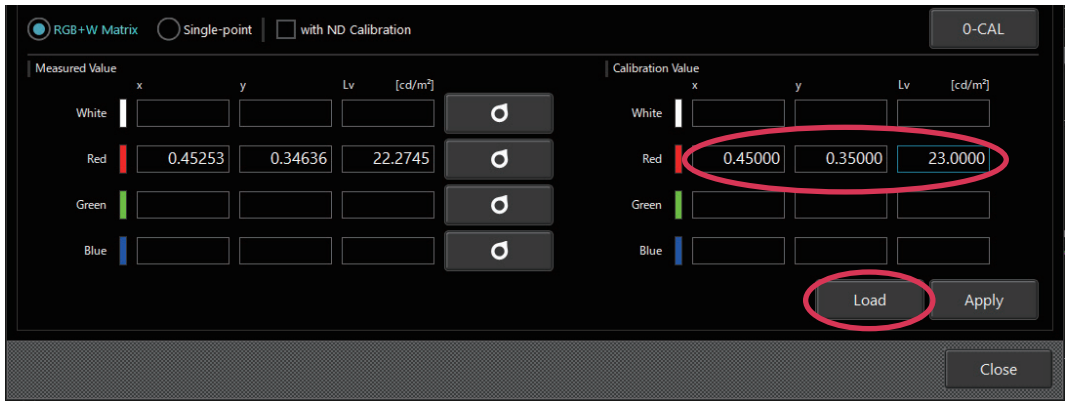

Text file content:

```
<White x value> <White y value> <White Lv value>
<Red x value> <Red y value> <Red Lv value>
<Green x value> <Green y value> <Green Lv value>
<Blue x value> <Blue y value> <Blue Lv value>
```

Text file content (Example):

```
0.3130 0.3230 99.6200
0.6520 0.3460 21.3200
0.3070 0.6380 74.0000
0.1500 0.0340 4.3000
```

* Use only "." for decimal points.

* Digit separators are not supported.

Reading will be successful even if a blank exists in the 4 × 3 format, but an error will occur if anything other than a numeric value is included.

When a 4 × 3 format file is loaded with single-point calibration, only the first row (white values) will be used.

- (8) After performing measurement and entering targets for all of Red, Green, Blue, and White, click the [Apply] button.
- To stop calibration, click [Close]. The change is not applied until the [Apply] button is clicked.

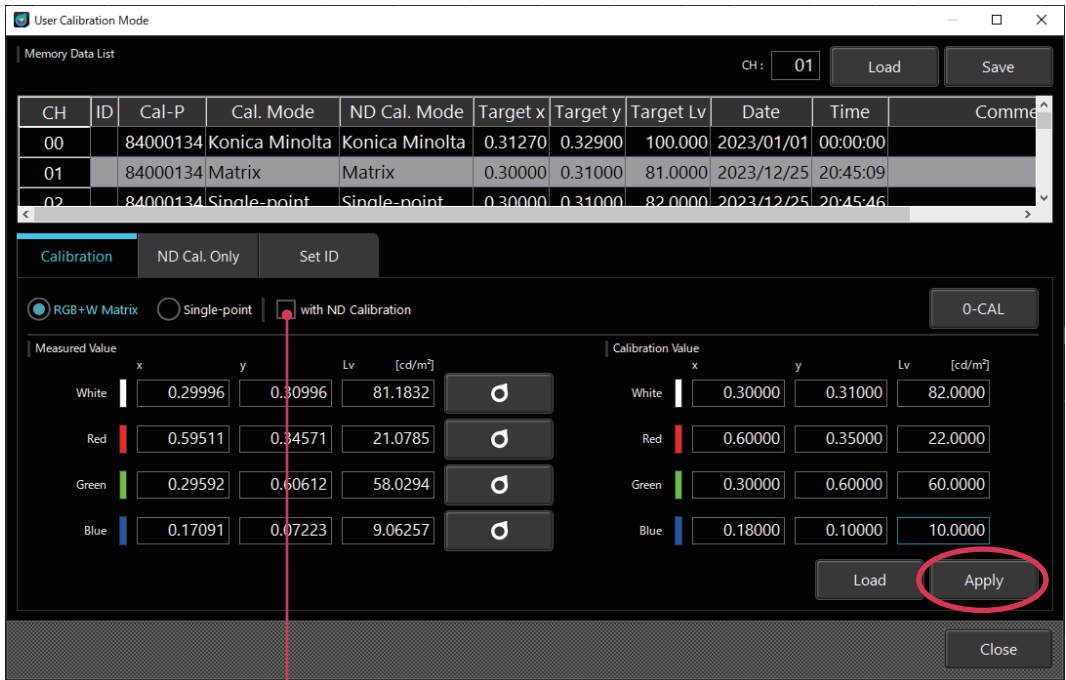

with ND Calibration

Memo • On the CA-527, you can also perform ND user correction by selecting the [with ND Calibration] check box.

2-2. ND user correction * Only functions when the CA-527 is connected

Use this function if you only want to run ND user correction.

- (1) Select the [ND Cal. Only] tab.
- (2) Select [RGB+W Matrix] or [Single-point] as the calibration mode.
 - When [RGB+W Matrix] is selected, White, Red, Green, and Blue are measured (in no particular order). When [Single-point] is selected, only White is measured.
- (3) Measurement is performed, and the measured value is displayed.

[Individual] measurement

- Calibration is performed while the measurement of each color is checked, the same as user calibration.
- When the measurement button to the right of each color is clicked, the [Color Window] changes to the target color, and a dialog box confirming the start of measurement is displayed.
- Click [OK] to start measurement.

[All] measurement

- All the colors are measured as a batch.
- The measurement order is White, Red, Green, Blue.
- When the measurement button to the right of each color is clicked, the [Color Window] changes to the target color, and a dialog box confirming the start of measurement is displayed.
- The measurement status is displayed as follows.

---- : Not performed

COMP : Normal completion

NOT COMP : Completion due to error

When [All] measurement is performed

: If [Individual] measurements have already been performed, all their results are discarded, and the status of each color is set to "----: Not performed."

When [Individual] measurement is performed

: If [All] measurement has already been performed, its results are discarded, and the status is set to "----: Not performed."

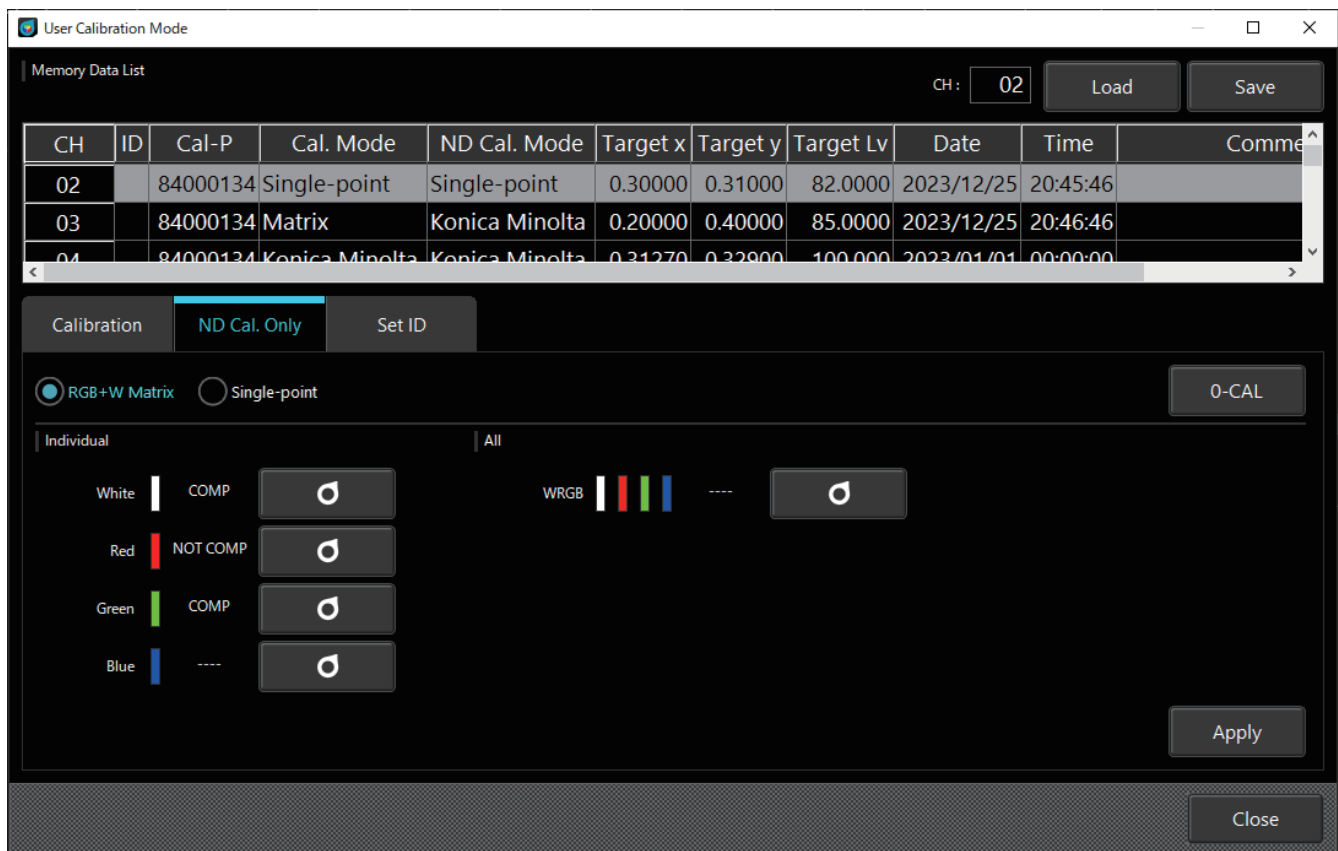

User calibration and ND user correction

2-3. ID setup

You can add an ID and comment to a calibration channel to make it easier to distinguish.

- (1) Select the [Set ID] tab.
- (2) Select a calibration channel. (CH00 to CH99)
 - Click over the calibration channel data.
- (3) Enter an ID in the ID text box. You can enter a comment in the Comment text box.
 - You can enter up to 10 alphanumeric characters for an ID and up to 50 alphanumeric characters as a comment.
- (4) Click [Apply]. The change is not applied until you click [Apply].
- (5) The entered ID and comment are applied.

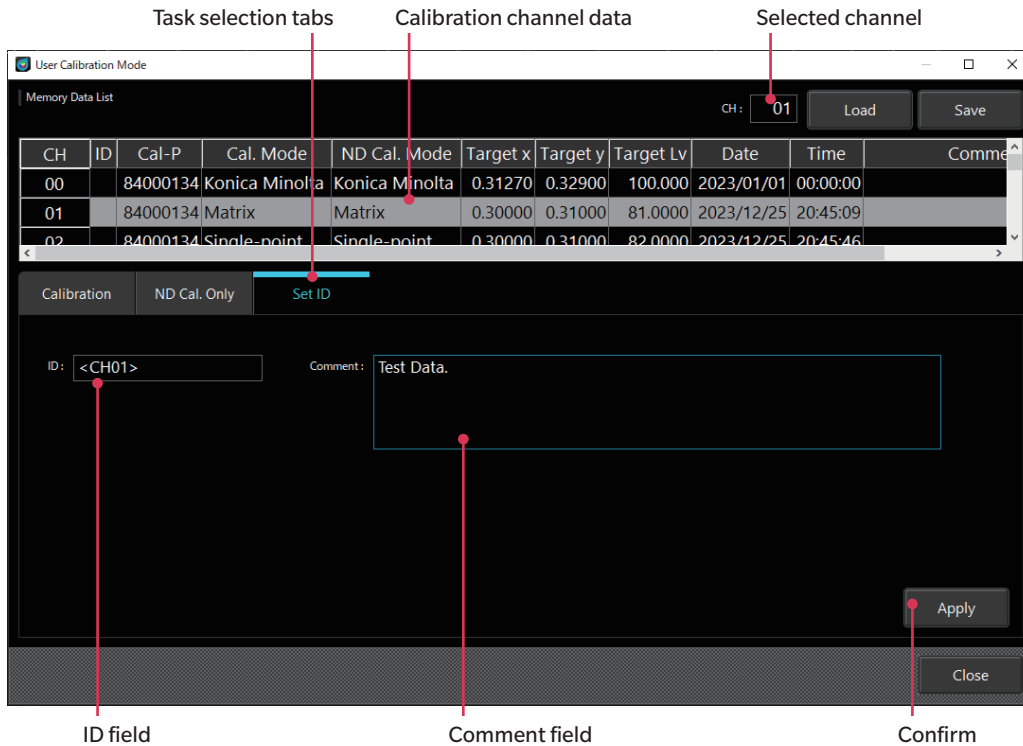

2-4. Selecting between user calibration and ND user correction

[1. When measuring with a user-provided light source as the standard]

Select the [Calibration] tab, and then select the [with ND calibration] check box.

ND user correction is performed together with user calibration.

- Memo** /
- When running ND user correction and user calibration separately, be sure to run ND user correction first.
 - If the luminance of the light source cannot be changed to approximately 600 cd/m² or less, clear the [with ND calibration] check box and only perform user calibration. However, the subtle misalignment in the linearity caused by inserting and removing the ND filter will be the same as before calibration.
 - If you only want to correct the subtle misalignment in the linearity caused by inserting and removing the ND filter, you can also perform only ND user correction as indicated in [2.] below.

[2. When using Konica Minolta's standard light source as the standard or when you do not have your own standard light source]

Select the [ND Cal. Only] tab. Only ND user correction is performed.

<Notes on user calibration>

- Correction coefficients are used for all measurement modes (Lv xy, Lv u' v', Lv Tcp duv, XYZ, and Lvλd Pe).
- You cannot perform user calibration for channel CH00.
(CH00 is a channel for performing measurement in accordance with the Konica Minolta calibration standard.)
- Performing RGB+W matrix calibration for a preset channel erases the last-set value.
- Performing RGB+W matrix calibration for a single-point-calibrated channel erases the correction coefficients for the last single-point calibration and sets correction coefficients for RGB+W matrix calibration.
- The target value used is written to a calibration channel as its target. If target data is already written in that calibration channel, it is overwritten.

3. Specifying the calibration coefficients <Settings> window

To perform measurement using your own correction coefficients, specify which calibration channel's correction coefficients you want to use. Specify [CH00] to perform measurement without performing correction but in accordance with the Konica Minolta standard.

3-1. Selecting a calibrated channel

- (1) Click [Settings] to bring up the following pop-up window for setting the measurement conditions and optional items.
- (2) In the [CH ID:] field under [Memory Info.] in the [Setting] tab, select a calibrated calibration channel. The target saved to the calibration channel is displayed in the pane below for your review.
- (3) Click [OK] to confirm the calibration channel for which the correction coefficients are to be used. The pop-up closes. Click [Cancel] to close the pop-up without confirming the calibration channel.

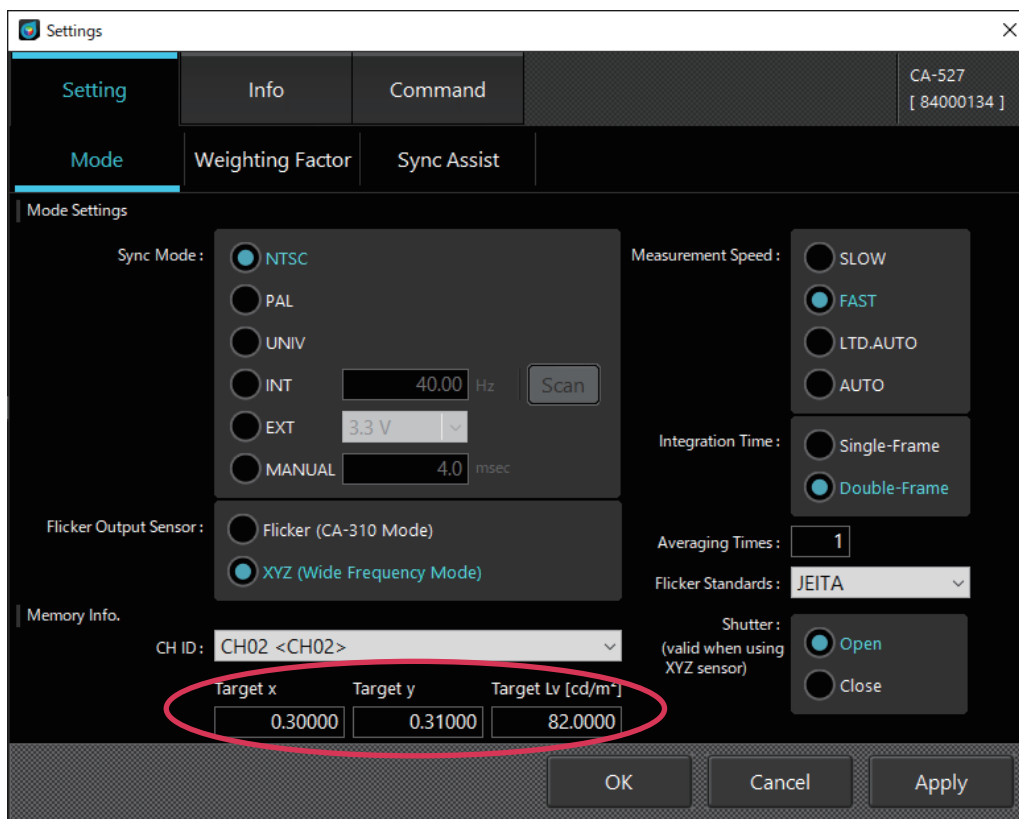

Data processor data

1. Handling of stored data

The stored data are the measurement results stored in the data processor.

You can measure a single data using up to 10 probes and 100 Data can be registered.

- (1) When Data is selected in the Data list on the [Measurement Data] tab
 - When you click the [File Save] button, all the measurement results of the probe used for measurement in the selected Data are saved.
 - Click [Data Delete] to erase all measurement results of the selected Data.
 - Click [All Delete] to erase all Data.
- (2) When Probe is selected in the Data list on the [Measurement Data] tab
 - When you click the [File Save] button, the measurement results of all Data measured with the selected probe are saved.
 - Click [Data Delete] to erase Data on the selected probe.
 - When you click [All Delete], all data will be deleted on the screen and in the data processor.

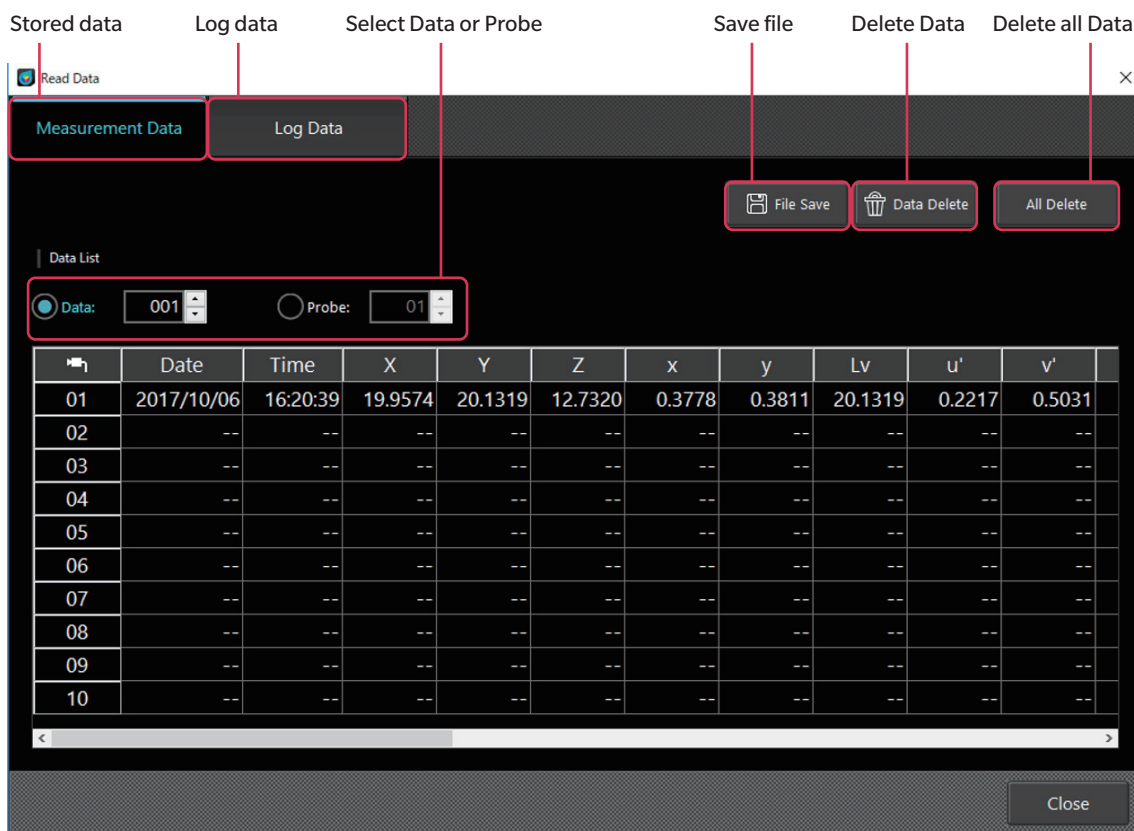

2. Handling of Log data

One Log Data has the Data of the number of probes for the measured times.

Log No. / date and time measurement started / date and time measurement stopped / data number tabs are displayed on the Log Data screen.

- Select the Log No. you want to save and click the [File Save] button to save the measurement result of the selected Log No.
- When you click [All Delete], all data will be deleted on the screen and in the data processor.

The screenshot shows a software interface for handling log data. At the top, there are two tabs: "Measurement Data" and "Log Data". The "Log Data" tab is active. Below the tabs, there are two buttons: "File Save" and "All Delete". A "Data List" table is displayed below the buttons. The table has four columns: "Log No.", "Start Date Time", "Stop Date Time", and "Data Num". The table contains 13 rows of data. The first four rows have specific dates and times, while the remaining rows have "--" in the date and time columns. A "Close" button is located at the bottom right of the screen.

Labels above the screenshot indicate the following elements:

- Stored data (points to the Measurement Data tab)
- Log data (points to the Log Data tab)
- Save file (points to the File Save button)
- Delete all Data (points to the All Delete button)

Log No.	Start Date Time	Stop Date Time	Data Num
001	2017/10/05 19:02:24	2017/10/05 19:02:34	2
002	2017/10/06 16:20:39	2017/10/06 16:20:39	1
003	2017/10/06 16:24:19	2017/10/06 16:24:49	4
004	2017/10/11 10:52:03	2017/10/11 10:52:23	3
005	--	--	--
006	--	--	--
007	--	--	--
008	--	--	--
009	--	--	--
010	--	--	--
011	--	--	--
012	--	--	--
013	--	--	--

Appendix

Troubleshooting	63
Error message	64
Caution	65
Instruction.....	68
Information	70

Troubleshooting

- If you perform a linearity evaluation of the light source to measure and find there is misalignment (continuity changes) in the linearity of the measurement results, check the information in [User calibration and ND user correction], and then perform various calibrations.

Error message

The operation is not correct. Follow the instructions displayed immediately.

Message	Details
--Failed to write or read memory. --Reconnect the probe.	A memory error has occurred inside the probe. If this condition persists after reconnecting, contact a service center to deal with the possible malfunction.
--System error --Restart application and a device	A program operation error has occurred inside the probe or SDK. If this condition persists after restarting, contact a service center to deal with the possible malfunction.
--SDK has problem --Restart SDK.	A program operation error has occurred inside the SDK. If this condition persists after restarting, contact a service center to deal with the possible malfunction.
Unknown error.	An unknown error code has been returned from the SDK. Due to the possibility of having an incompatible version, re-installation is recommended.
Cannot calibrate selected channel.	The selected channel cannot be calibrated. If the channel in question is not CH00, that channel may be locked. Contact a service center.
--Calibration type of the arbitrary Calibration and the ND filter are different.	The calibration type of the specified ND filter is different.

Caution

The setting or operation is not correct.

Message	Details
Cannot open the manual. Make sure that a PDF reader is installed and it is set as the default app for PDFs.	PDF viewer software for displaying the instruction manual cannot be opened. Check whether PDF viewer software is installed and set to default.
Cannot find the manual. Please check your app installation.	The instruction manual is not found. The manual may have been moved from the correct folder path. Re-install CA-S40.
Failed to connect to selected probe. Please check probe connection.	This message appears when connection to a probe fails while a data processor is connected. Check the connection with the probe, and establish the connection again after restarting CA-S40.
CA device not connected. Please connect device.	This message appears when CA-S40 is started without connecting a probe/ data processor. Restart CA-S40 after checking the connection.
Y(Luminance) [Max] input value error. Please input -999999999999.0 to 999999999999.0.	This is an error in the manual setting of the vertical axis scale in the Waveform graph. The maximum value must be greater than -999999999999.0, but less than 999999999999.0.
Y(Luminance) [Min] input value error. Please input -999999999999.0 to 999999999999.0.	This is an error in the manual setting of the vertical axis scale in the Waveform graph. The minimum value must be less 999999999999.0, but greater than -999999999999.0.
[Max] and [Min] cannot be the same.	The maximum and minimum values may not be the same.
Failed to re-connect to device. Please disconnect and connect the device again.	Reconnection to the device failed. The device must be reconnected.
Failed to connect to device. Please check device connection.	Reconnection of the device failed. Check the device connection status.
Cannot complete measurement. (ERROR: [SDK error message])	Measurement failed. Follow the instructions in the error message.
Device connection failed. Please check selected device.	Reconnection of the device failed. Check the device connection status.
Cannot calibrate CH00. Select other CH.	CH00 cannot be calibrated. Specify a different channel for calibration.
[WHITE/RED/GREEN/BLUE Lv] input value error. Please input 0.00001 to 99999.0	True value input of Lv for one of the RGBW colors is out of range. Input a value between 0.00001 and 99999.0.
[WHITE/RED/GREEN/BLUE x] input value error. Please input 0.00001 to 0.99999.	True value input of x for one of the RGBW colors is out of range. Input a value between 0.00001 and 0.99999.
[WHITE/RED/GREEN/BLUE y] input value error. Please input 0.00001 to 0.99999.	True value input of y for one of the RGBW colors is out of range. Input a value between 0.00001 and 0.99999.
[WHITE/RED/GREEN/BLUE x] or [WHITE/RED/GREEN/BLUE y] input value error. Make sure $x+y \leq 1$.	True value input of x or y for one of the RGBW colors is out of range. Check whether $x + y$ is 1 or less.
Invalid memory channel ID. ID is too long (Max of 10 characters only).	Memory ID input character count exceeds character limit.
Invalid memory channel comment. Comment is too long (Max of 50 characters only).	Comment input character count exceeds character limit.
Loaded file is invalid. Please select .dat file.	Loaded calibration data file has incorrect data format.
[Times] input value error. Please input a valid number.	A non-numeric value is entered for the number of measurements for interval measurement. Use only numeric values.

Caution

Message	Details
[Times] input value error. Please input 0 - 40000 measurements.	An out-of-range value is entered for the number of measurements for interval measurement. Use a value within the specified range.
[sec] input value error. Please input a valid number.	A non-numeric value is entered for the measurement interval time for interval measurement. Use only numeric values.
[sec] input value error. Please input 0 - 7259 sec.	The measurement time interval input is out of range when the interval count is specified within 1 to 4000. Enter a value within 0 to 7259 seconds.
[sec] input value error. Please input 1 - 7259 sec.	The measurement time interval input is out of range when the interval count is specified within 4001 to 40000. Enter a value within 1 to 7259 seconds.
[Wait] input value error. Please input a valid number.	A non-numeric value is entered for the inter-tone wait time for gamma measurement. Use only numeric values.
[Wait] input value error. Please input 0 - 36000 x 10 msec.	An out-of-range value is entered for the inter-tone wait time for gamma measurement. Enter a value within 0 to 36000.
INT Sync Mode setting is invalid. Please go to Settings and set INTvalue to 0.50 - 130.00 Hz.	Sync Mode INT out of range is entered for FMA measurement. Enter a value within 0.50 Hz to 130.00 Hz.
MANUAL Sync Mode setting is invalid. Please go to Settings and set MANUAL value to 7.7 - 4000.0 msec.	Sync Mode INT out of range is entered for FMA measurement. Enter a value within 7.7 to 4000.0 msec.
[INT] input value error. Please input a valid number.	A non-numeric value is entered for Sync Mode INT. Use only numeric values.
[Window for VRRF] input value error. Please input a valid number.	A non-numeric value is entered for Window for VRRF. Use only numeric values.
[Measurement Time] input value error. Please input a valid number.	A non-numeric value is entered for Measurement Time. Use only numeric values.
[Sampling Freq.] input value error. Please input a valid number.	A non-numeric value is entered for Sampling Freq. Use only numeric values.
[Measurement Time] and [Window for VRRF] input values error. Please input Measurement Time bigger than Window for VRRF.	Invalid values were entered for Measurement Time and Window for VRRF. Enter in Measurement Time a value that is greater than or equal to the value entered in Window for VRRF.
[INT] input value error. Please input 0.50 - 240.00 Hz.	An out-of-range value is entered for Sync Mode INT for colorimetry. Use a value within the specified range.
[INT] input value error. Please input 0.50 - 130.00 Hz.	An out-of-range value is entered for Sync Mode INT for FMA measurement. Use a value within the specified range.
[MANUAL] input value error. Please input a valid number.	A non-numeric value is entered for Sync Mode MANUAL. Use only numeric values.
[MANUAL] input value error. Please input 4.0 - 4000.0 msec.	An out-of-range value is entered for Sync Mode MANUAL for colorimetry. Use a value within the specified range.
[MANUAL] input value error. Please input 7.7 - 4000.0 msec.	An out-of-range value is entered for Sync Mode MANUAL for FMA measurement. Use a value within the specified range.
[Averaging Times] input value error. Please input a valid number.	A non-numeric value is entered for averaging times. Use only numeric values.
[Averaging Times] input value error. Please input 1 - 255.	An out-of-range value is entered for the number of averaging measurements. Use a value within the specified range.
File format is incorrect. Please input a valid file.	Weighting factor data could not be read. Check the file format.
Cannot get the saved weighting factor data.	Weighting coefficient data for flicker that has been read cannot be acquired. Load the weighting coefficient data file again.
File path does not exist. Please input a valid path.	File path is incorrect. Specify the correct path.

Message	Details
User-defined weighting factor data was not loaded. The previous setting will be retained. Do you want to proceed?	File cannot be loaded because of an error in the file format. Use the current settings or try applying the settings again.
The weighting factor setting will be reverted to the previous setting. Do you want to proceed?	Settings reverted to the original setting.
Cannot overwrite existing file. Check that it is not in use.	Data cannot be saved to file due to reasons such as the save file is currently in used. Check the file.
--No sync_signal. --Input an external synchronization signal.	Vertical synchronization signals are not input in external synchronization mode. Check the signal transmitter and the connection status.
--Data value is too high. --Set a color within CA's measuring range.	The brightness of the measurement target exceeds the upper limit. Either adjust the brightness so that it is within the measurable range or use a high-luminance probe.
--Failed to calculate color temp. --Retry the measurement.	Retry the measurement.
--FMA Flicker Value is out of range.	Retry the measurement.
X(Time) [Min] cannot be greater than [Max].	This is an error in the manual setting of the horizontal axis scale in the Waveform graph. The minimum value must be less than the maximum value.
EXT Sync Mode setting is invalid. Please input a VSYNC signal of 0.50 - 240.00 Hz at the 1.8 V CMOS input level.	The external synchronization signal is invalid. (The external synchronization signal is set to less than 0.5 Hz or greater than 240 Hz.) Input a VSYNC signal between 0.50 and 240.00 Hz using the 1.8 V CMOS input level.
EXT Sync Mode setting is invalid. Please input a VSYNC signal of 0.50 - 240.00 Hz at the 3.3 - 5.0 V CMOS input level.	The external synchronization signal is invalid. (The external synchronization signal is set to less than 0.5 Hz or greater than 240 Hz.) Input a VSYNC signal between 0.50 and 240.00 Hz using the 3.3 to 5.0 V CMOS input level.
EXT Sync Mode setting is invalid. Please input a VSYNC signal of 0.50 - 130.00 Hz at the 1.8 V CMOS input level.	The external synchronization signal is invalid. (The external synchronization signal is set to less than 0.5 Hz or greater than 130 Hz.) Input a VSYNC signal between 0.50 and 130.00 Hz using the 1.8 V CMOS input level.
EXT Sync Mode setting is invalid. Please input a VSYNC signal of 0.50 - 130.00 Hz at the 3.3 - 5.0 V CMOS input level.	The external synchronization signal is invalid. (The external synchronization signal is set to less than 0.5 Hz or greater than 130 Hz.) Input a VSYNC signal between 0.50 and 130.00 Hz using the 3.3 to 5.0 V CMOS input level.
EXT Sync Mode setting is invalid. Please input a VSYNC signal of 0.50 - 400.00 Hz at the 1.8 V CMOS input level.	The external synchronization signal is invalid. (The external synchronization signal is set to less than 0.5 Hz or greater than 400 Hz.) Input a VSYNC signal between 0.50 and 400.00 Hz using the 1.8 V CMOS input level.
EXT Sync Mode setting is invalid. Please input a VSYNC signal of 0.50 - 400.00 Hz at the 3.3 - 5.0 V CMOS input level.	The external synchronization signal is invalid. (The external synchronization signal is set to less than 0.5 Hz or greater than 400 Hz.) Input a VSYNC signal between 0.50 and 400.00 Hz using the 3.3 to 5.0 V CMOS input level.
--Device not found. --Check Device.	No device could be found. Check the device connection status.
There is no periodicity. Please use the reference frequency (20.00 Hz) when you cannot find the frequency by Waveform measurement.	No periodicity could be detected. If the frequency cannot be determined using Waveform measurement, please use the reference value (UNIVERSAL: 20.00 Hz).
The detected frequency is out of specification range.	No periodicity could be found within the range of detection. Use Waveform measurement to determine the frequency.
Loaded file is invalid. Please check the contents of the file.	The file format is incorrect.
Failed to load memory data.	The file may be corrupted.

Instruction

The flow of operation is displayed. Perform the operation according to the information displayed.

Message	Details
Please wait for a moment.	A task is running. Please wait until the task is completed.
Transferring to datalist...	Continuous/Interval measurement data is being transferred from the buffer to the list. Please wait until the task is completed.
Please perform 0-CAL.	This message appears when zero calibration is required. Perform zero calibration according to the information displayed.
Continuous measurement in progress. Please stop measurement first.	This message appears when you try to exit the application while Continuous measurement is running. Exit the application after stopping the measurement.
Interval measurement in progress. Please stop measurement first.	This message appears when you try to exit the application while Interval measurement is running. Exit the application after stopping the measurement.
Closing the application will clear all measurement data. Do you want to proceed?	This message appears when you try to exit the application when there is still measurement data. If the measurement data needs to be saved, use the [Save to CSV] button to save the data before exiting the application.
The device was changed. Do you want to apply the current settings including memory CH to the new device?	This message appears when a new device has been connected to the application. If you want to use the settings for an existing device, click [Yes]. If you want to use the settings in the new device, click [No].
Start 0-CAL?	This message appears when the zero calibration button is pressed. Press [No] if you are not running the zero calibration.
Please input a valid number.	This message appears when an invalid value (such as characters) is entered for true value input for calibration. Enter a numeric value.
Start [WHITE/RED/GREEN/BLUE] measurement?	A message is displayed prompting whether or not to perform monochromatic measurement for calibration. While this message is displayed, you can change the position of the Color Window for measurement.
Start Target setting?	This message prompts whether or not to set the target.
The work is processing. Switch to other tab?	Switching to another tab results in the loss of edits and measurement data. If necessary, finish the tasks before switching tabs.
Delete data from all probes?	This message asks for confirmation whether to delete the data in the selected channel that saves measurement data.
Delete all data?	This message asks for confirmation whether to delete all data in the channels that save measurement data.
Overwrite [file name]?	This message asks for confirmation whether to overwrite the file for channels that save measurement data.
Executing continuous measurement will clear previous measurement data. Do you want to proceed?	This message appears when you try to run a continuous measurement while there is measurement data. If the measurement data is necessary, save it before running the measurement.
Executing interval measurement using the supplied interval times parameter will cause the list to exceed the limit. This requires clearing all previous measurement data. Do you want to proceed?	This message appears when you try to run an interval measurement while there is measurement data. If the measurement data is necessary, save it before running the measurement.
Executing package measurement will clear previous measurement data. Do you want to proceed?	This message appears when you try to run a package measurement while there is measurement data. If the measurement data is necessary, save it before running the measurement.
Executing Gamma measurement will clear previous measurement data. Do you want to proceed?	This message appears when you try to run a gamma measurement while there is measurement data. If the measurement data is necessary, save it before running the measurement.
Executing measurement will clear gamma measurement data. Do you want to proceed?	This message appears when you try to run another measurement while there is gamma measurement data. If the measurement data is necessary, save it before running the measurement.

Message	Details
Entering gamma measurement mode will clear previous measurement data. Do you want to proceed?	This message appears when you try to open the gamma measurement window while there is measurement data. If the measurement data is necessary, save it before running the measurement.
Closing the window will clear Gamma measurement data and graphs. Do you want to proceed?	This message appears when you try to close the gamma window while there is gamma measurement data. If the measurement data is necessary, save it before running the measurement.
Changing frequency resolution will clear previous flicker measurement data. Do you want to proceed?	This message appears when trying to change the JEITA/VESA frequency resolution conditions while there is JEITA/VESA measurement data. If the measurement data is necessary, save it before running the measurement.
Would you like to adjust the brightness for ND calibration? Current luminance: [luminance] cd/m ² Target brightness: [brightness] cd/m ² Saturation: [saturation] %	This message appears when the luminance is not appropriate during ND user correction. Refer to Target brightness and adjust the brightness so that Saturation does not exceed 100%.
Changing JEITA measurement mode will clear current JEITA data. Is this okay?	This message appears when you try to change the measurement mode while there is JEITA measurement data. If the measurement data is necessary, save it before running the measurement.
Changing VESA measurement mode will clear current VESA data. Is this okay?	This message appears when you try to change the measurement mode while there is VESA measurement data. If the measurement data is necessary, save it before running the measurement.
The work is processing. Switch to Single-point Calibration?	Switching to single-point calibration results in the loss of edits and measurement data. If necessary, finish the tasks before switching the calibration.
The work is processing. Switch to RGB+W Matrix Calibration?	Switching to RGB+W matrix calibration results in the loss of edits and measurement data. If necessary, finish the tasks before switching the calibration.
Executing measurement will clear the oldest data. Do you want to proceed?	This message appears when you run a measurement while there is measurement data. If the measurement data is necessary, save it before running the measurement.
Data size will exceed max capacity of 40000. To continue measurement, please delete data from the list.	This message appears when the number of measurements reaches the maximum limit. Save the data first, and then clear it.
Delete data?	This message appears when deleting list data. If you need the data, save it first.
Start Gamma Measurement? Tone: [User specified tone] Wait Time: [User specified time] msec	Start gamma measurement? Tone: [User-specified tone] Wait time: [User-specified time] msec
The device was changed. Do you want to apply current settings including memory CH to the new device?	The settings from the previously connected device can be applied to the newly connected device.
Please specify image format	Specify the image format.
Cannot save current data in file **	Measurement values cannot be saved.
Trigger measurement will be performed. In this application, commands up to the line where "TMS,1" is entered will be sent. After that, reception of trigger measurement results will be performed repeatedly.	Perform trigger measurement. In this application, commands up to the line where "TMS,1" is entered will be transmitted (commands entered after that line will be invalid). After that, the trigger measurement results are received repeatedly.
The amount of data that can be received in trigger mode has been exceeded. Instrument will exit from trigger mode.	The amount of data that can be received in trigger mode has been exceeded. The device will exit trigger mode.
Please remove the cap.	Remove the lens cap.
All measurements are not possible. Please perform Individual measurement.	Batch measurement is not possible. Perform individual measurements.

Information

Updated information is provided.

Message	Details
New CA device is connected.	This message appears when a different device is connected after the USB connection has been disconnected or when there is a device switchover from the Settings screen.
New probe is connected.	This message appears when a separate probe is selected while a data processor is connected.
Another PC Software for Color Analyzer instance is already running.	This message indicates a repeated launch attempt. Multiple copies of the software cannot run simultaneously.
Re-connection to device in progress...	Re-connection to the device is in progress. Wait without unplugging the USB flash drive.
0-CAL in progress. . .	Zero calibration is in progress.
Measurement is cancelled.	The measurement has been canceled.
RGB+W Matrix is successfully applied.	RGB+W matrix calibration has been successfully completed.
Single-point is successfully applied.	Single-point calibration has been successfully completed.
Set Target is successfully applied.	Color difference target has been successfully set.
ID and Comment are successfully applied.	ID and comment have been successfully set.
Calibration measurement failed.	Measurement for calibration failed.
Target measurement failed.	Measurement for setting the target failed.
Read data in progress. . .	Data processor data is being read.
Saving Log Data No. ([saved] / [all]): Overall ([saved] / [all])	Log data is being saved.
No data selected.	Data has not been selected.
Cannot delete measurement data.	Measurement data cannot be deleted.
No data to save.	There is no data to be saved.
Gamma measurement cancelled.	Gamma measurement has been canceled.
Interval measurement in progress...	Interval measurement is in progress.
Package measurement in progress...	Package measurement is in progress.
JEITA flicker measurement in progress...	JEITA measurement is in progress.
Reading memory...	Memory is being read.
Please check the boxes corresponding to the colors to be measured.	No color has been selected to be measured. Check the check boxes of the colors to be measured.
Color measurement in progress...	Color measurement is in progress.
FMA measurement in progress...	FMA measurement is in progress.
VESA measurement in progress...	VESA measurement is in progress.
Waveform measurement in progress...	Waveform measurement is in progress.
Updating lists might take a few minutes.	It may take several minutes for the list to refresh.
ND calibration factor measurement was not completed successfully. W: [COMP/NOT COMP] R: [COMP/NOT COMP] G: [COMP/NOT COMP] B: [COMP/NOT COMP] ND calibration factor is not updated.	ND calibration coefficient measurement did not complete normally. W: [complete/not complete] R: [complete/not complete] G: [complete/not complete] B: [complete/not complete] ND calibration coefficients have not been updated.
ND calibration factor measurement was not completed successfully. W: [COMP/NOT COMP] ND calibration factor is not updated.	ND calibration coefficient measurement did not complete normally. W: [complete/not complete] ND calibration coefficients have not been updated.
VRR measurement in progress...	VRRF flicker measurement is in progress.

List display color, error code: List color displayed on data processor, error code

List display color	Error Code	Meaning
White	—	—
Blue	1:Different from cal Probe	The probe(s) being used are different from when user calibration / target setting and measurement was performed.
Blue	2:Δt out of range	The temperature inside the probe has changed more than the specified amount since zero calibration.
Blue	3:Δt out of range	Error code 1 and error code 2 occurred at the same time.
Blue	4:Below measurement range	Measurement is out of measurement range.
Blue	5:Out of measurement range	Error code 1 and error code 4 occurred at the same time.
Blue	6: Δt out of range	Error code 2 and error code 4 occurred at the same time.
Blue	7: Δt out of range	Error code 1, error code 2, and error code 4 occurred at the same time.
Yellow	10:Problem with CA device	There is a problem with the CA device.
Yellow	20:Out of EXT range	External synchronization signal is invalid. (External synchronization signal is set to less than 0.5 Hz or over 240 Hz.)
Yellow	50:FMA value over 999.9%	The measured value in flicker mode exceeds 999.9%.
Yellow	51:Out of EXT range for FMA	Synchronization signal is invalid in FMA flicker mode. (The synchronization signal is set at less than 0.5 Hz or over 130 Hz.)
Yellow	53:Not flicker probe	CA-VP 410 , CA-VP410A, CA-VP427, CA-VP427A, CA-VP404, CA-VP402 or CA-VP410T is connected in flicker mode.
White	64:Low Battery	Battery level is low.
Blue	65:Low Battery + other errors	Error code 1 and error code 64 occurred at the same time.
Blue	66:Low Battery + other errors	Error code 2 and error code 64 occurred at the same time.
Blue	67:Low Battery + other errors	Error code 1, error code 2, and error code 64 occurred at the same time.
Blue	68:Low Battery + other errors	Error code 4 and error code 64 occurred at the same time.
Blue	69:Low Battery + other errors	Error code 1, error code 4, and error code 64 occurred at the same time.
Blue	70:Low Battery + other errors	Error code 2, error code 4, and error code 64 occurred at the same time.
Blue	71:Low Battery + other errors	Error code 1, error code 2, error code 4, and error code 64 occurred at the same time.

* If correlated color temperature or dominant wavelength cannot be calculated, "----" is displayed as measured value.

* If there is a colorimetric value that has not been measured when reading the data of the data processor, its colorimetric value will be displayed as "-9999", "- 99999999", etc.

Information

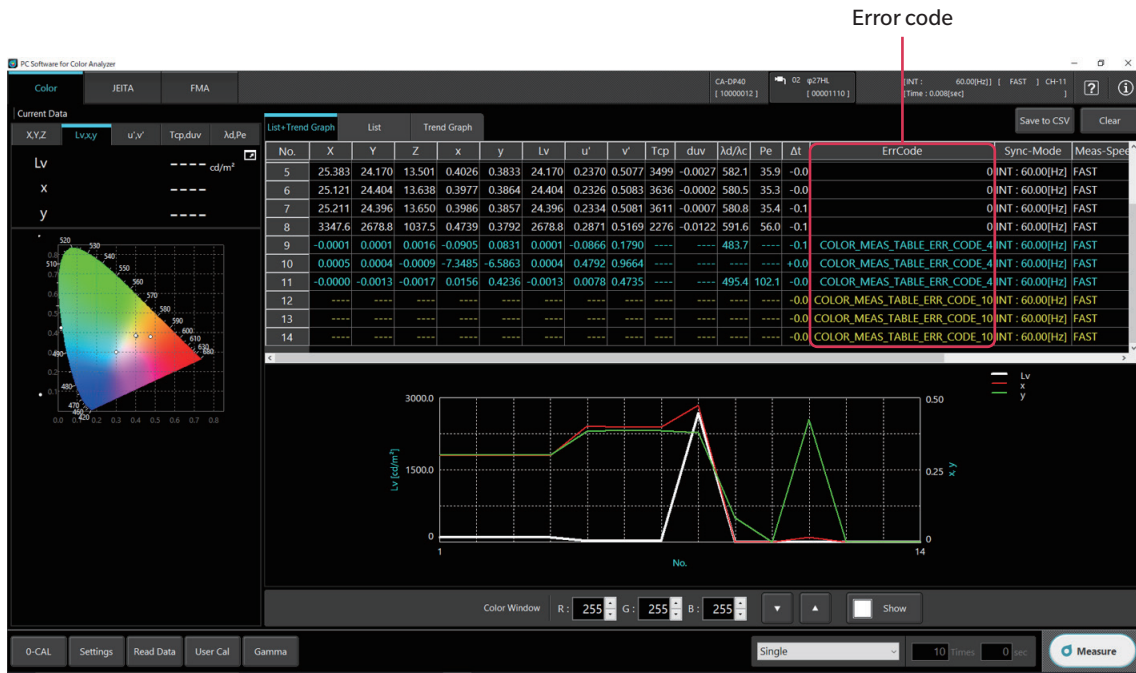

For the error code displayed on the List in yellow, the error message shown in the table below is displayed after measurement is completed.

Error message	Meaning
Problem with CA device. Please check configuration or device conditions.	There is a problem with the CA device. Check the settings and the CA device status.
Invalid external synchronization signal (External synchronization signal set to less than 0.5 Hz, over 240 Hz).	External synchronization signal is invalid. (External synchronization signal is set to less than 0.5 Hz or over 240 Hz.)
Over measurement range.	The tristimulus value of the measurement subject is too large.
Measurement value is over 999.9% in flicker mode.	The measured value exceeds 999.9% in FMA measurement.
External synchronizing signal is over 130 Hz in the FMA flicker mode.	Frequency input exceeded 130 Hz in FMA measurement.
Flicker measurement is being attempted using a Probe CA-VP410, CA-VP410A, CA-VP427, CA-VP427A, CA-VP404, CA-VP402, or CA-VP410T.	CA-VP 410, CA-VP410A, CA-VP427, CA-VP427A, CA-VP404, CA-VP402 or CA-VP410T is connected in flicker mode.

< CAUTION >

KONICA MINOLTA WILL NOT BE LIABLE FOR ANY DAMAGES RESULTING FROM THE MISUSE, MISHANDLING, UNAUTHORIZED MODIFICATION, ETC. OF THIS PRODUCT, OR FOR ANY INDIRECT OR INCIDENTAL DAMAGES (INCLUDING BUT NOT LIMITED TO LOSS OF BUSINESS PROFITS, INTERRUPTION OF BUSINESS, ETC.) DUE TO THE USE OF OR INABILITY TO USE THIS PRODUCT.



KONICA MINOLTA



KONICA MINOLTA

Main Specifications of Display Color Analyzer CA-527

CA-527



Measurement area		Φ 27 mm			
Accuracy guaranteed measurement distance		30 ± 5 mm			
Luminance	Accuracy guaranteed range *7		0.0001 to 10,000 cd/m ²		
	Accuracy (for white)*1, *3	> 0.0001 cd/m ²	± 9 %		
		> 0.001 cd/m ²	± 2 %		
		> 0.01 cd/m ²	± 1.5 %		
		> 0.1 cd/m ²	± 1.5 %		
		> 1 cd/m ²	± 1.5 %		
	Repeatability (2σ) *1	AUTO	> 0.0001 cd/m ²	10 %	
		> 0.001 cd/m ²	1 %		
		> 0.01 cd/m ²	0.30 %		
		> 0.1 cd/m ²	0.12 %		
> 1 cd/m ²		0.10 %			
> 10 cd/m ²	0.10 %				
Chromaticity	Accuracy guaranteed luminance range*7		0.001 to 10,000 cd/m ²		
	Accuracy (for white)*1, *3	> 0.001 cd/m ²	± 0.003		
		> 0.01 cd/m ²	± 0.002		
		> 0.1 cd/m ²	± 0.002		
		> 1 cd/m ²	± 0.002		
		> 10 cd/m ²	± 0.002		
	Repeatability (2σ) *1	AUTO	At 100 cd/m ² (for monochrome)*2	> 100 cd/m ²	± 0.003
		> 0.001 cd/m ²	0.0030		
		> 0.01 cd/m ²	0.0009		
		> 0.1 cd/m ²	0.0004		
> 1 cd/m ²		0.0002			
> 10 cd/m ²	0.0002				
Flicker (CA-310 Mode) *6	Flicker (Contrast)	Measurement luminance range *7		0.5 to 10,000 cd/m ²	
		Measurement target (Flicker frequency)		0.25 to 65 Hz	
		Accuracy	30 Hz, AC/DC 10% sine wave	± 0.3 %	
			60 Hz, AC/DC 10% sine wave	± 0.3 %	
	Repeatability (2σ)	20-65 Hz, AC/DC 10% sine wave	0.3 %		
	Flicker (JEITA)	Measurement luminance range *7		0.5 to 10,000 cd/m ²	
		Measurement target (Flicker frequency)		0.42 to 65 Hz	
		Accuracy	30 Hz, AC/DC 4% sine wave	± 0.35 dB	
			30 Hz, AC/DC 1.2% sine wave	± 0.35 dB	
	Repeatability (2σ)	30 Hz, AC/DC 4% sine wave	0.1 dB		
	30 Hz, AC/DC 1.2% sine wave	0.3 dB			
	Waveform	Measurement luminance range *7		0.1 to 10,000 cd/m ²	
Sampling frequency		200 kHz Changeable			
Repeatability (2σ)		Lv: 0.1cd/m ² , fs: 3kHz, fc: 1kHz	1.8 %		
Measurement luminance range *7		0.5 to 10,000 cd/m ²			
Sampling frequency		200 kHz Changeable			
VRR-Flicker	Measurement target (Flicker frequency)		0.25 to 240 Hz		
	Accuracy	1-120 Hz, AC/DC 10% sine wave	± 0.3 %		
		30 Hz, AC/DC 4% sine wave	± 0.3 %		
	Repeatability (2σ)	1-120 Hz, AC/DC 10% sine wave	0.3 %		
XYZ (Wide Frequency Mode) *6	Flicker (Contrast)	Measurement luminance range *7		0.5 to 10,000 cd/m ²	
		Measurement target (Flicker frequency)		0.25 to 200 Hz	
		Accuracy	30 Hz, AC/DC 10% sine wave	± 1.5 %	
			60 Hz, AC/DC 10% sine wave	± 2.2 %	
	Repeatability (2σ)	20-65 Hz, AC/DC 10% sine wave	1.6 %		
	Flicker (JEITA)	Measurement luminance range *7		0.5 to 8,500 cd/m ²	
		Measurement target (Flicker frequency)		0.42 to 200 Hz	
		Accuracy	30 Hz, AC/DC 4% sine wave	± 0.35 dB	
			30 Hz, AC/DC 1.2% sine wave	± 0.35 dB	
	Repeatability (2σ)	30 Hz, AC/DC 4% sine wave	0.4 dB		
	30 Hz, AC/DC 1.2% sine wave	1.4 dB			
	Waveform	Measurement luminance range *7		0.1 to 10,000 cd/m ²	
Sampling frequency		3 kHz Changeable			
Repeatability (2σ)		Lv: 0.1 cd/m ²	13 %		
		Lv: 1 cd/m ²	1.4 %		
Accuracy guaranteed measurement speed *4	Lvxy	AUTO	1 times/sec (> 0.01 cd/m ²)		
		5 times/sec (> 0.15 cd/m ²)			
	Flicker (Contrast)		20 times/sec		
	Flicker (JEITA/ VESA)		0.5 times/sec (at 1 HzPitch), 2.5 times/sec (at 10 HzPitch)		
VRR-Flicker		Sampling frequency 3 kHz	0.7 times/sec (at 1s Exp.)		
Measurement synchronization mode		NTSC, PAL, EXT, UNIV, INT, MANU (4 ms ~ 4 s)			
Measurement speed mode		AUTO, LTD. AUTO, SLOW, FAST			
Measurement target (Vertical synchronization frequency)		0.5 to 240 Hz (luminance and chromaticity)			
User calibration memory channel		99 channels			
Interface	Communication		USB2.0, RS-232C		
	Trigger		IN: 1.8 V / 3.3 to 5 V switching Out: 5 V		
Size (mm)		52 x 52 x 272			
Weight		710 g (including mount)			
Power supply		DC 5 V (input from USB bus power line or RS communication connector)			
Operation temperature/humidity range *5		10 to 35°C, relative humidity 85% or less with no condensation			
Storage temperature/humidity range		0 to 45°C, relative humidity 85% or less (at 35°C) with no condensation			



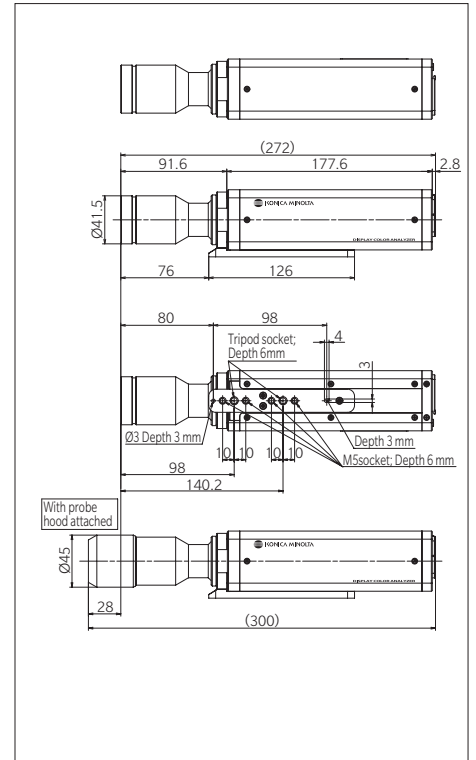







Dimension (unit: mm)



- *1 Measured under Konica Minolta's standard light source (6,500K).
 - *2 Luminance for monochrome is measured when reading of luminance for white is 100 cd/m².
 - *3 Temperature 23°C/±2°C, relative humidity 40%±10%.
 - *4 In NTSC synchronization mode using USB with one probe.
 - *5 Reading fluctuation (compared to reference reading at 23°C, 40% RH): Luminance: ±2% for white; Chromaticity (at 100 cd/m²): ±0.002 for white, ±0.003 for monochrome.
 - *6 "Flicker (CA-310 Mode)" and "XYZ (Wide Frequency Mode)" are mode names for PC Software CA-S40.
 - *7 Measured under Konica Minolta's standard light source (constant light). If the luminance momentarily greatly exceeds the upper limit, such as with a PWM light source with a small duty cycle, luminances below the upper limit may be shown as too high.
- * Unless otherwise specified, specifications are given for conditions established by Konica Minolta.

● KONICA MINOLTA, the Konica Minolta logo and symbol mark are registered trademarks or trademarks of KONICA MINOLTA, INC.

● The specifications and appearance shown herein are subject to change without notice.

		CA-VP427A	CA-VP427	CA-P427	CA-P427H	CA-VP410A	CA-VP410	CA-VP410T	CA-P410	CA-P410H	CA-VP404	CA-VP402		
		Advanced High Sensitivity Probe	High Sensitivity Probe	Normal Probe	High Luminance Probe	Advanced High Sensitivity Probe	High Sensitivity Probe	LWD Probe	Normal Probe	High Luminance Probe	Small Spot Probe	Small Spot Probe		
														
Measurement area		Ø 27 mm	Ø 27 mm	Ø 27 mm	Ø 27 mm	Ø 10 mm	Ø 10 mm	Approx. Ø 10 mm	Ø 10 mm	Ø 10 mm	Ø 4 mm	Ø 2.1 mm		
Acceptance angle		± 2.5°	± 2.5°	± 2.5°	± 2.5°	± 8.5°	± 8.5°	± 4°	± 5°	± 5°	± 8.5°	± 10°		
Accuracy guaranteed measurement distance		30 ± 10 mm	30 ± 10 mm	30 ± 10 mm	30 ± 10 mm	30 ± 5 mm	30 ± 5 mm	200 ± 2 mm	30 ± 5 mm	30 ± 5 mm	30 ± 2 mm	28 ± 2 mm		
Display range	Luminance ¹⁾	0.0001 to 5,000 cd/m ²	0.0001 to 3,000 cd/m ²	0.0001 to 5,000 cd/m ²	0.0001 to 30,000 cd/m ²	0.0001 to 3,000 cd/m ²	0.0001 to 3,000 cd/m ²	0.0001 to 12,000 cd/m ²	0.0001 to 5,000 cd/m ²	0.0001 to 30,000 cd/m ²	0.0001 to 12,000 cd/m ²	0.0001 to 6,000 cd/m ²		
	Chromaticity	Displayed in 4 digits	Displayed in 4 digits	Displayed in 4 digits	Displayed in 4 digits	Displayed in 4 digits	Displayed in 4 digits	Displayed in 4 digits	Displayed in 4 digits	Displayed in 4 digits	Displayed in 4 digits	Displayed in 4 digits		
Accuracy guaranteed range ²⁾		0.0003 to 5,000 cd/m ²	0.001 to 3,000 cd/m ²	0.001 to 5,000 cd/m ²	0.01 to 30,000 cd/m ²	0.0003 to 3,000 cd/m ²	0.001 to 3,000 cd/m ²	0.004 to 12,000 cd/m ²	0.01 to 5,000 cd/m ²	0.1 to 30,000 cd/m ²	0.004 to 12,000 cd/m ²	0.002 to 6,000 cd/m ²		
Luminance	Accuracy (for white) ^{1), 3)}	> 0.0003 cd/m ²	± 9%	± 9%	± 9%	± 9%	± 9%	± 9%	± 9%	± 9%	± 9%	± 9%		
		> 0.001 cd/m ²	± 4%	± 9%	± 9%	± 9%	± 4%	± 9%	± 9%	± 9%	± 9%	± 9%	± 9%	
		> 0.01 cd/m ²	± 2%	± 2%	± 2%	± 9%	± 2.5%	± 2.5%	± 9%	± 2.5%	± 2.5%	± 9%	± 9%	
		> 0.1 cd/m ²	± 1.5%	± 1.5%	± 1.5%	± 2%	± 2%	± 2%	± 3%	± 2%	± 2%	± 3%	± 3%	
		> 1 cd/m ²	± 1.5%	± 1.5%	± 1.5%	± 1.5%	± 2%	± 2%	± 3%	± 2%	± 2%	± 3%	± 3%	
	Repeatability (2σ) ¹⁾	AUTO	> 0.0003 cd/m ²	10%	---	---	7%	---	---	---	---	---	---	
		> 0.001 cd/m ²	4%	10%	10%	10%	3%	7%	10% (0.004 to cd/m ²)	---	---	10% (0.004 to cd/m ²)	10% (0.002 to cd/m ²)	
		> 0.01 cd/m ²	1%	1%	1%	10%	1%	1%	5%	2%	---	5%	10%	
		> 0.1 cd/m ²	0.25%	0.25%	0.40%	1%	0.25%	0.25%	0.50%	0.60%	2%	0.50%	1%	
		> 1 cd/m ²	0.10%	0.10%	0.10%	0.40%	0.10%	0.10%	0.20%	0.20%	0.60%	0.20%	0.25%	
Accuracy guaranteed luminance range ³⁾		0.003 to 5,000 cd/m ²	0.01 to 3,000 cd/m ²	0.01 to 5,000 cd/m ²	0.1 to 30,000 cd/m ²	0.003 to 3,000 cd/m ²	0.01 to 3,000 cd/m ²	0.04 to 12,000 cd/m ²	0.01 to 5,000 cd/m ²	0.1 to 30,000 cd/m ²	0.04 to 12,000 cd/m ²	0.02 to 6,000 cd/m ²		
Chromaticity	Accuracy (for white) ^{1), 3)}	> 0.003 cd/m ²	± 0.003	---	---	± 0.003	---	---	---	---	---	---		
		> 0.01 cd/m ²	± 0.002	± 0.003	± 0.003	---	± 0.002	± 0.003	± 0.006	± 0.006	± 0.004 (0.04 to cd/m ²)	± 0.004 (0.02 to cd/m ²)		
		> 0.1 cd/m ²	± 0.002	± 0.002	± 0.002	± 0.003	± 0.002	± 0.002	± 0.002	± 0.002	± 0.006	± 0.004		
		> 1 cd/m ²	± 0.002	± 0.002	± 0.002	± 0.002	± 0.002	± 0.002	± 0.003	± 0.002	± 0.002	± 0.003		
		> 10 cd/m ²	± 0.002	± 0.002	± 0.002	± 0.002	± 0.002	± 0.002	± 0.003	± 0.002	± 0.002	± 0.003		
	At 100 cd/m ² (for monochrome) ^{1), 2)}	> 100 cd/m ²	± 0.002	± 0.002	± 0.002	± 0.002	± 0.002	± 0.002	± 0.002	± 0.002	± 0.002	± 0.002	± 0.002	
		100 cd/m ²	± 0.003	± 0.003	± 0.003	± 0.003	± 0.003	± 0.003	± 0.003	± 0.003	± 0.003	± 0.003	± 0.003	
		Repeatability (2σ) ¹⁾	AUTO	> 0.003 cd/m ²	0.0030	---	---	0.0020	---	---	---	---	---	---
			> 0.01 cd/m ²	0.0030	0.0030	0.0035	---	0.0020	0.0020	0.0030 (0.04 to cd/m ²)	0.0070	---	0.0030 (0.04 to cd/m ²)	0.003 (0.02 to cd/m ²)
			> 0.1 cd/m ²	0.0008	0.0008	0.0015	0.0035	0.0008	0.0008	0.0015	0.0020	0.0070	0.0015	0.003
> 1 cd/m ²	0.0003		0.0003	0.0004	0.0015	0.0003	0.0003	0.0005	0.0008	0.0020	0.0005	0.0008		
> 10 cd/m ²	0.0002		0.0002	0.0003	0.0004	0.0002	0.0002	0.0003	0.0005	0.0008	0.0003	0.0003		
Flicker (CA-310 Mode) ⁶⁾	Flicker (Contrast)	Measurement luminance range ⁸⁾	---	---	5 to 1,500 cd/m ²	30 to 9,000 cd/m ²	---	---	---	15 to 3,000 cd/m ²	90 to 18,000 cd/m ²	---		
		Measurement target (Flicker frequency)	---	---	0.25 to 65 Hz	0.25 to 65 Hz	---	---	---	0.25 to 65 Hz	0.25 to 65 Hz	---	---	
		Accuracy	30 Hz, AC/DC 10% sine wave	---	± 0.4%	± 0.4%	---	---	---	± 0.4%	± 0.4%	---	---	
		60 Hz, AC/DC 10% sine wave	---	---	± 0.7%	± 0.7%	---	---	---	± 0.7%	± 0.7%	---	---	
		Repeatability (2σ)	20-65 Hz, AC/DC 10% sine wave	---	0.3%	0.3%	---	---	---	0.3%	0.3%	---	---	
	Flicker (JEITA)	Measurement luminance range ⁸⁾	---	---	5 to 1,500 cd/m ²	30 to 9,000 cd/m ²	---	---	---	15 to 3,000 cd/m ²	90 to 18,000 cd/m ²	---	---	
		Measurement target (Flicker frequency)	---	---	0.42 to 65 Hz	0.42 to 65 Hz	---	---	---	0.42 to 65 Hz	0.42 to 65 Hz	---	---	
		Accuracy	30 Hz, AC/DC 4% sine wave	---	± 0.35 dB	± 0.35 dB	---	---	---	± 0.35 dB	± 0.35 dB	---	---	
		30 Hz, AC/DC 1.2% sine wave	---	---	± 0.35 dB	---	---	---	---	± 0.35 dB	---	---	---	
		Repeatability (2σ)	30 Hz, AC/DC 4% sine wave	---	0.1 dB	0.1 dB	---	---	---	0.1 dB	0.1 dB	---	---	
30 Hz, AC/DC 1.2% sine wave	---	---	0.3 dB	---	---	---	---	0.3 dB	---	---	---			
XYZ (Wide Frequency Mode) ⁶⁾	Flicker (Contrast)	Measurement luminance range ⁸⁾	5 to 3,000 cd/m ²	5 to 3,000 cd/m ²	5 to 5,000 cd/m ²	30 to 30,000 cd/m ²	15 to 3,000 cd/m ²	15 to 3,000 cd/m ²	20 to 12,000 cd/m ²	15 to 5,000 cd/m ²	90 to 30,000 cd/m ²	20 to 12,000 cd/m ²	35 to 6,000 cd/m ²	
		Measurement target (Flicker frequency)	0.25 to 200 Hz	0.25 to 200 Hz	0.25 to 200 Hz	0.25 to 200 Hz	0.25 to 200 Hz	0.25 to 200 Hz	0.25 to 200 Hz	0.25 to 200 Hz	0.25 to 200 Hz	0.25 to 200 Hz	0.25 to 200 Hz	0.25 to 200 Hz
		Accuracy	30 Hz, AC/DC 10% sine wave	± 1.1%	± 1.1%	± 1.2%	± 1.2%	± 0.4%	± 0.4%	± 1.1%	± 0.7%	± 0.7%	± 1.1%	± 1.1%
		60 Hz, AC/DC 10% sine wave	---	± 1.7%	± 1.7%	± 1.7%	± 1.7%	± 1.7%	± 1.7%	± 1.7%	± 1.1%	± 1.1%	± 1.7%	± 1.7%
		Repeatability (2σ)	20-65 Hz, AC/DC 10% sine wave	1.6%	1.6%	1.7%	1.7%	0.3%	0.3%	0.16	1.0%	1.0%	1.6%	1.6%
	Flicker (JEITA)	Measurement luminance range ⁸⁾	5 to 3,000 cd/m ²	5 to 3,000 cd/m ²	5 to 4,500 cd/m ²	30 to 27,000 cd/m ²	15 to 2,000 cd/m ²	15 to 2,000 cd/m ²	20 to 12,000 cd/m ²	15 to 5,000 cd/m ²	90 to 30,000 cd/m ²	20 to 12,000 cd/m ²	35 to 6,000 cd/m ²	
		Measurement target (Flicker frequency)	0.42 to 200 Hz	0.42 to 200 Hz	0.42 to 200 Hz	0.42 to 200 Hz	0.42 to 200 Hz	0.42 to 200 Hz	0.42 to 200 Hz	0.42 to 200 Hz	0.42 to 200 Hz	0.42 to 200 Hz	0.42 to 200 Hz	
		Accuracy	30 Hz, AC/DC 4% sine wave	± 0.35 dB	± 0.35 dB	± 0.35 dB	± 0.35 dB	± 0.35 dB	± 0.35 dB	± 0.35 dB	± 0.35 dB	± 0.35 dB	± 0.35 dB	
		30 Hz, AC/DC 1.2% sine wave	---	± 0.35 dB	± 0.35 dB	---	± 0.35 dB	± 0.35 dB	± 0.35 dB	± 0.35 dB	---	± 0.35 dB	± 0.35 dB	
		Repeatability (2σ)	30 Hz, AC/DC 4% sine wave	0.4 dB	0.4 dB	0.4 dB	0.4 dB	0.1 dB	0.4 dB	0.3 dB	0.3 dB	0.4 dB	0.4 dB	
30 Hz, AC/DC 1.2% sine wave	1.4 dB	1.4 dB	1.5 dB	---	0.3 dB	0.3 dB	1.4 dB	0.9 dB	---	1.4 dB	1.4 dB			
Waveform	Measurement luminance range ⁸⁾	1 to 3,000 cd/m ²	1 to 3,000 cd/m ²	1 to 5,000 cd/m ²	6 to 30,000 cd/m ²	1 to 2,500 cd/m ²	1 to 2,500 cd/m ²	4 to 12,000 cd/m ²	1 to 5,000 cd/m ²	6 to 30,000 cd/m ²	4 to 12,000 cd/m ²	7 to 6,000 cd/m ²		
	Sampling frequency	3 kHz	3 kHz	3 kHz	3 kHz	3 kHz	3 kHz	3 kHz	3 kHz	3 kHz	3 kHz	3 kHz		
Accuracy guaranteed measurement speed ⁴⁾	Lvxy	AUTO	0.16 times/sec (> 0.0003 cd/m ²)	---	---	---	0.16 times/sec (> 0.0003 cd/m ²)	---	---	---	---	0.16 times/sec (> 0.002 cd/m ²)		
			1 times/sec (> 0.01 cd/m ²)	1 times/sec (> 0.001 cd/m ²)	1 times/sec (> 0.001 cd/m ²)	1 times/sec (> 0.01 cd/m ²)	1 times/sec (> 0.01 cd/m ²)	1 times/sec (> 0.01 cd/m ²)	1 times/sec (> 0.004 cd/m ²)	1 times/sec (> 0.01 cd/m ²)	1 times/sec (> 0.1 cd/m ²)	1 times/sec (> 0.004 cd/m ²)	1 times/sec (> 0.05 cd/m ²)	
			5 times/sec (> 0.15 cd/m ²)	5 times/sec (> 0.15 cd/m ²)	5 times/sec (> 0.15 cd/m ²)	5 times/sec (> 0.15 cd/m ²)	5 times/sec (> 0.15 cd/m ²)	5 times/sec (> 0.15 cd/m ²)	5 times/sec (> 0.6 cd/m ²)	5 times/sec (> 0.15 cd/m ²)	5 times/sec (> 0.9 cd/m ²)	5 times/sec (> 0.6 cd/m ²)	5 times/sec (> 1.5 cd/m ²)	
			20 times/sec (> 2 cd/m ²)	20 times/sec (> 2 cd/m ²)	20 times/sec (> 2 cd/m ²)	20 times/sec (> 12 cd/m ²)	20 times/sec (> 2 cd/m ²)	20 times/sec (> 2 cd/m ²)	20 times/sec (> 8 cd/m ²)	20 times/sec (> 2 cd/m ²)	20 times/sec (> 12 cd/m ²)	20 times/sec (> 8 cd/m ²)	20 times/sec (> 25 cd/m ²)	
			20 times/sec	20 times/sec	20 times/sec	20 times/sec	20 times/sec	20 times/sec	20 times/sec	20 times/sec	20 times/sec	20 times/sec	20 times/sec	
Flicker (JEITA)		0.5 times/sec (at 1 HzPitch), 2.5 times/sec (at 10 HzPitch)	0.5 times/sec (at 1 HzPitch), 2.5 times/sec (at 10 HzPitch)	0.5 times/sec (at 1 HzPitch), 2.5 times/sec (at 10 HzPitch)	0.5 times/sec (at 1 HzPitch), 2.5 times/sec (at 10 HzPitch)	0.5 times/sec (at 1 HzPitch), 2.5 times/sec (at 10 HzPitch)	0.5 times/sec (at 1 HzPitch), 2.5 times/sec (at 10 HzPitch)	0.5 times/sec (at 1 HzPitch), 2.5 times/sec (at 10 HzPitch)	0.5 times/sec (at 1 HzPitch), 2.5 times/sec (at 10 HzPitch)	0.5 times/sec (at 1 HzPitch), 2.5 times/sec (at 10 HzPitch)	0.5 times/sec (at 1 HzPitch), 2.5 times/sec (at 10 HzPitch)	0.5 times/sec (at 1 HzPitch), 2.5 times/sec (at 10 HzPitch)		
Measurement synchronization mode														
Measurement speed mode														
NTSC, PAL, EXT, UNIV, INT, MANU(4 ms to 4 s)														
AUTO, LTD, AUTO, SLOW, FAST														
Measurement target (Vertical synchronization frequency)		0.5 to 240 Hz (luminance and chromaticity)	0.5 to 240 Hz (luminance and chromaticity)	0.5 to 240 Hz (luminance and chromaticity), 0.5 to 130 Hz (flicker)	0.5 to 240 Hz (luminance and chromaticity), 0.5 to 130 Hz (flicker)	0.5 to 240 Hz (luminance and chromaticity)	0.5 to 240 Hz (luminance and chromaticity)	0.5 to 240 Hz (luminance and chromaticity)	0.5 to 240 Hz (luminance and chromaticity), 0.5 to 130 Hz (flicker)	0.5 to 240 Hz (luminance and chromaticity), 0.5 to 130 Hz (flicker)	0.5 to 240 Hz (luminance and chromaticity)	0.5 to 240 Hz (luminance and chromaticity)		
User calibration memory channel														
99 channels														
Interface	Communication													
	USB2.0, RS-232C													
Trigger ⁵⁾														
IN: 1.8 V / 3.3 to 5 V switching Out: 5 V														
Size (mm)		47 x 47 x 190.5	47 x 47 x 190.5	42 x 42 x 139.7	42 x 42 x 139.7	47 x 47 x 226.5	47 x 47 x 226.5	47 x 47 x 226.2	42 x 42 x 173.5	42 x 42 x 173.5	47 x 47 x 226.5	47 x 47 x 222.9		
Weight		510 g (including mount)	510 g (including mount)	270 g (including mount)	270 g (including mount)	570 g (including mount)	570 g (including mount)	550 g (including mount)	280 g (including mount)	280 g (including mount)	570 g (including mount)	580 g (including mount)		
Power supply														
DC 5 V (input from USB bus power line or RS communication connector)														
Operation temperature/humidity range ⁵⁾														
10 to 35°C, relative humidity 85% or less with no condensation														
Storage temperature/humidity range														
0 to 45°C, relative humidity 85% or less (at 35°C) with no condensation														

¹⁾ Measured under Konica Minolta's standard light source (6,500K).
²⁾ Luminance for monochrome is measured when reading of luminance for white is 100 cd/m².
³⁾ Temperature 23°C/±2°C, relative humidity 40%±10%
⁴⁾ In NTSC synchronization mode using USB with one probe
⁵⁾ Reading fluctuation (compared to reference reading at 23°C, 40% RH): Luminance: ±2% for white; Chromaticity (at 100 cd/m²): ±0.002 for white, ±0.003 for monochrome
⁶⁾ "Flick

Main Specifications of CA-410 Probes

		CA-P427C	CA-P410C	CA-MP410	CA-MP410H		
		CIE 170-2: 2015 Supported Probe ⁷		Mini Probe			
Measurement area		Ø 27 mm	Ø 10 mm	Ø 10 mm	Ø 10 mm		
Acceptance angle		± 2.5°	± 5°	± 5°	± 5°		
Accuracy guaranteed measurement distance		30 ± 10 mm	30 ± 5 mm	10 ± 5 mm	10 ± 5 mm		
Display range	Luminance ²	0.0001 to 5,000 cd/m ²	0.0001 to 5,000 cd/m ²	0.0001 to 5,000 cd/m ²	0.0001 to 30,000 cd/m ²		
	Chromaticity	Displayed in 4 digits	Displayed in 4 digits	Displayed in 4 digits	Displayed in 4 digits		
Luminance	Accuracy guaranteed range ³		0.001 to 5,000 cd/m ²	0.01 to 5,000 cd/m ²	0.01 to 5,000 cd/m ²	0.1 to 30,000 cd/m ²	
	Accuracy (for white) ^{1, 3}	> 0.0003 cd/m ²	---	---	---	---	
		> 0.001 cd/m ²	± 9 %	---	---	---	
		> 0.01 cd/m ²	± 2 %	± 2.5 %	± 2.5 %	---	
		> 0.1 cd/m ²	± 1.5 %	± 2 %	± 2 %	± 2.5 %	
		> 1 cd/m ²	± 1.5 %	± 2 %	± 2 %	± 2 %	
		> 10 cd/m ²	± 1.5 %	± 1.5 %	± 1.5 %	± 2 %	
	Repeatability (2σ) ¹	> 0.0003 cd/m ²	---	---	---	---	
		> 0.001 cd/m ²	10 %	---	---	---	
		> 0.01 cd/m ²	1 %	2 %	2.40 %	---	
		> 0.1 cd/m ²	0.4 %	0.6 %	0.70 %	2.40 %	
		> 1 cd/m ²	0.10 %	0.20 %	0.25 %	0.70 %	
		> 10 cd/m ²	0.10 %	0.10 %	0.12 %	0.25 %	
	Chromaticity	Accuracy guaranteed luminance range ³		0.01 to 5,000 cd/m ²	0.01 to 5,000 cd/m ²	0.01 to 5,000 cd/m ²	0.1 to 30,000 cd/m ²
Accuracy (for white) ^{1, 3}		> 0.003 cd/m ²	---	---	---	---	
		> 0.01 cd/m ²	± 0.003	± 0.006	± 0.006	---	
		> 0.1 cd/m ²	± 0.002	± 0.002	± 0.002	± 0.006	
		> 1 cd/m ²	± 0.002	± 0.002	± 0.002	± 0.002	
		> 10 cd/m ²	± 0.002	± 0.002	± 0.002	± 0.002	
		> 100 cd/m ²	± 0.002	± 0.002	± 0.002	± 0.002	
At 100 cd/m ² (for monochrome) ¹²		100 cd/m ²	± 0.003	± 0.003	± 0.003	± 0.003	
		> 0.003 cd/m ²	---	---	---	---	
Repeatability (2σ) ¹		> 0.01 cd/m ²	0.0035	0.007	0.0085	---	
		> 0.1 cd/m ²	0.0015	0.0020	0.0025	0.0085	
		> 1 cd/m ²	0.0004	0.0008	0.0010	0.0025	
		> 10 cd/m ²	0.0003	0.0005	0.0006	0.0010	
		> 100 cd/m ²	0.0002	0.0003	0.0004	0.0006	
	> 100 cd/m ²	0.0002	0.0003	0.0004	0.0006		
Flicker (CA-310 Mode) ¹⁶	Flicker (Contrast)	Measurement luminance range ⁸	5 to 1,500 cd/m ²	15 to 3,000 cd/m ²	15 to 3,000 cd/m ²	90 to 18,000 cd/m ²	
		Measurement target (Flicker frequency)	0.25 to 65 Hz	0.25 to 65 Hz	0.25 to 65 Hz	0.25 to 65 Hz	
		Accuracy	30 Hz, AC/DC 10% sine wave 60 Hz, AC/DC 10% sine wave	± 0.4 % ± 0.7 %	± 0.4 % ± 0.7 %	± 0.4 % ± 0.7 %	
	Flicker (JEITA)	Measurement luminance range ⁸	5 to 1,500 cd/m ²	15 to 3,000 cd/m ²	15 to 3,000 cd/m ²	90 to 18,000 cd/m ²	
		Measurement target (Flicker frequency)	0.42 to 65 Hz	0.42 to 65 Hz	0.42 to 65 Hz	0.42 to 65 Hz	
		Accuracy	30 Hz, AC/DC 4% sine wave 30 Hz, AC/DC 1.2% sine wave	± 0.35 dB ± 0.35 dB	± 0.35 dB ± 0.35 dB	± 0.35 dB ---	
	Waveform	Repeatability (2σ)	30 Hz, AC/DC 4% sine wave 30 Hz, AC/DC 1.2% sine wave	0.1 dB 0.3 dB	0.1 dB 0.3 dB	0.1 dB ---	
		Measurement luminance range ⁸	5 to 5,000 cd/m ²	15 to 5,000 cd/m ²	15 to 5,000 cd/m ²	90 to 30,000 cd/m ²	
		Measurement target (Flicker frequency)	0.25 to 200 Hz	0.25 to 200 Hz	0.25 to 200 Hz	0.25 to 200 Hz	
	XYZ (Wide Frequency Mode) ¹⁶	Flicker (Contrast)	Accuracy	30 Hz, AC/DC 10% sine wave 60 Hz, AC/DC 10% sine wave	± 1.2 % ± 1.7 %	± 0.9 % ± 1.1 %	± 0.9 % ± 1.3 %
			Repeatability (2σ)	20-65 Hz, AC/DC 10% sine wave	1.7 %	1.0 %	1.3 %
			Measurement luminance range ⁸	5 to 4,500 cd/m ²	15 to 5,000 cd/m ²	15 to 5,000 cd/m ²	90 to 30,000 cd/m ²
Flicker (JEITA)		Measurement target (Flicker frequency)	0.42 to 200 Hz	0.42 to 200 Hz	0.42 to 200 Hz	0.42 to 200 Hz	
		Accuracy	30 Hz, AC/DC 4% sine wave 30 Hz, AC/DC 1.2% sine wave	± 0.35 dB ± 0.35 dB	± 0.35 dB ± 0.35 dB	± 0.35 dB ---	
		Repeatability (2σ)	30 Hz, AC/DC 4% sine wave 30 Hz, AC/DC 1.2% sine wave	0.4 dB 0.9 dB	0.3 dB 1.2 dB	0.3 dB ---	
Waveform		Measurement luminance range ⁸	1 to 5,000 cd/m ²	1 to 5,000 cd/m ²	1 to 5,000 cd/m ²	6 to 30,000 cd/m ²	
		Sampling frequency	3 kHz	3 kHz	3 kHz	3 kHz	
Accuracy guaranteed measurement speed ⁴		Lvxy	AUTO	1 times/sec (> 0.001 cd/m ²) 5 times/sec (> 0.15 cd/m ²) 20 times/sec (> 2 cd/m ²)	1 times/sec (> 0.01 cd/m ²) 5 times/sec (> 0.15 cd/m ²) 20 times/sec (> 2 cd/m ²)	1 times/sec (> 0.01 cd/m ²) 5 times/sec (> 0.15 cd/m ²) 20 times/sec (> 2 cd/m ²)	1 times/sec (> 0.1 cd/m ²) 5 times/sec (> 0.9 cd/m ²) 20 times/sec (> 12 cd/m ²)
			Flicker (Contrast)	20 times/sec	20 times/sec	20 times/sec	20 times/sec
			Flicker (JEITA)	0.5 times/sec (at 1 HzPitch), 2.5 times/sec (at 10 HzPitch)	0.5 times/sec (at 1 HzPitch), 2.5 times/sec (at 10 HzPitch)	0.5 times/sec (at 1 HzPitch), 2.5 times/sec (at 10 HzPitch)	0.5 times/sec (at 1 HzPitch), 2.5 times/sec (at 10 HzPitch)
Measurement synchronization mode: NTSC, PAL, EXT, UNIV, INT, MANU (4 ms to 4 s)							
Measurement speed mode: AUTO, LTD, AUTO, SLOW, FAST							
Measurement target (Vertical synchronization frequency): 0.5 to 240 Hz (luminance and chromaticity), 0.5 to 130 Hz (flicker)							
User calibration memory channel: 99 channels							
Communication: USB2.0, RS-232C							
Trigger ⁵ : IN: 1.8V / 3.3 to 5V switching Out: 5V							
Size (mm): 42 x 42 x 139.7							
Weight: 270 g (including mount)							
Power supply: DC 5 V (input from USB bus power line or RS communication connector)							
Operation temperature/humidity range ¹³ : 10 to 35°C, relative humidity 85% or less with no condensation							
Storage temperature/humidity range: 0 to 45°C, relative humidity 85% or less (at 35°C) with no condensation							

¹: Measured under Konica Minolta's standard light source (6,500K).
²: Luminance for monochrome is measured when reading of luminance for white is 100 cd/m².
³: Temperature 23°C/±2°C, relative humidity 40%±10%
⁴: In NTSC synchronization mode using USB with one probe
⁵: Reading fluctuation (compared to reference reading at 23°C, 40% RH): Luminance: ±2% for white; Chromaticity (at 100 cd/m²): ±0.002 for white, ±0.003 for monochrome
⁶: "Flicker (CA-310 Mode)" and "XYZ (Wide Frequency Mode)" are mode names for PC Software CA-S40. "XYZ (Wide Frequency Mode)" can only be used when no CA-DP40 data processor is connected.

⁷: The spectral sensitivities of probes conforming to CIE 170-2:2015 are different from those defined for the CIE 1931 color-matching functions; therefore, displayed values for luminance and chromaticity will be different from those calculated based on the CIE 1931 color-matching functions.
⁸: Measured under Konica Minolta's standard light source (constant light). If the luminance momentarily greatly exceeds the upper limit, such as with a PWM light source with a small duty cycle, luminances below the upper limit may be shown as too high.
⁹: Supports 1.8V switching from products produced in March 2021.
¹⁰: Unless otherwise specified, specifications are given for conditions established by Konica Minolta.

Probe Dimensions (unit: mm)

