

# **SPECTRORADIOMETER**

**CS-3000HDR / CS-3000 / CS-2000Plus**

## **Instruction Manual**

 Please read before using  
the instrument.



**KONICA MINOLTA**

# Safety Symbols

The following symbols are used in this manual to prevent accidents which may occur as a result of incorrect use of the instrument.



**Denotes a sentence regarding a safety warning or caution.**  
**Read the sentence carefully to ensure safe and proper use of the instrument.**



**Denotes a prohibited operation.**  
**The operation must never be performed.**



**Denotes an instruction.**  
**The instruction must be strictly adhered to.**



**Denotes an instruction.**  
**Disconnect the power plug from the AC outlet.**



**Denotes a prohibited operation.**  
**Never disassemble the instrument.**



**Denotes alternating current (AC).**



**Denotes direct current (DC).**















**Denotes class II protection against electric shock.**

## Notes on This Manual

- Copying or reproduction of all or any part of the contents of this manual without KONICA MINOLTA's permission is strictly prohibited.
- The contents of this manual are subject to change without prior notice.
- Every effort has been made in the preparation of this manual to ensure the accuracy of its contents. However, should you have any questions or find any errors or omission, please contact the nearest **KONICA MINOLTA-authorized service facility**.
- KONICA MINOLTA will not accept any responsibility for consequences arising from the use of the instrument.

# Safety Precautions

To ensure correct use of the instrument, read the following points carefully and adhere to them. After you have read this manual, keep it in a safe place where it can be referred to anytime a question arises.

	<b>Warning</b> (Failure to adhere to the following points may result in death or serious injury)
	Do not use this instrument in places where flammable or combustible gases (gasoline, etc.) are present. Doing so may cause fire.
	Do not use this instrument when the inside is dirty with dust that has entered through the ventilation holes. Doing so may cause fire. For periodic inspections, please contact the nearest <b>KONICA MINOLTA-authorized service facility</b> .
	Always use the AC adapter (AC-A312G) supplied as a standard accessory and connect it to an indoor AC outlet of rated voltage and frequency (100-240 V $\sim$ , 50 Hz/60 Hz). Use of an AC adapter other than the one specified or connection to a different voltage may result in damage to the instrument, fire or electric shock.
	Fully insert the power plug until it is securely seated in the AC outlet. Failure to do so may result in fire or electric shock.
	If this instrument is not used for a long time, disconnect the AC adapter from the AC outlet. Accumulated dirt or water on the prongs of the AC adapter may cause fire. Accumulated dirt or water on the prongs of the AC adapter may cause fire and should be removed.
	When unplugging the power cord of the AC adapter, gently unplug it by holding the power plug. Do not forcibly pull the power cord when unplugging as this may damage it or cause fire or electric shock. Also, do not handle the power cord with wet hands. Doing so may cause electric shock.
	Do not forcibly bend, twist or pull the power cord. Also, do not place heavy objects on the power cord, or damage or modify it. Such actions may cause fire or electric shock due to damage to the power cord.
	Do not disassemble or modify this instrument or the AC adapter. Doing so may cause fire or electric shock.
	Do not spill liquid on this instrument or drop metallic objects onto it. Doing so may cause fire or electric shock. Should either of these happen, immediately switch the power off and unplug the AC adapter, and then contact the nearest <b>KONICA MINOLTA-authorized service facility</b> .
	Should this instrument or the AC adapter be damaged or emit smoke or an odd smell, do not keep using such instrument or AC adapter without correction. Doing so may cause fire. In such situations, immediately switch the power off and unplug the AC adapter, and then contact the nearest <b>KONICA MINOLTA-authorized service facility</b> .
	Do not look at the sun or intense light through the finder of this instrument. Doing so may cause loss of sight.

## **Caution**

(Failure to adhere to the following points may result in injury or damage to the instrument or other properties)



Use the instrument near an AC outlet so that the AC adapter can be easily plugged and unplugged.



Do not place the instrument on an unstable or sloping surface. Doing so may cause it to drop or overturn, resulting in injury. Take care not to drop the instrument when carrying it.



Do not move while looking inside the finder, as it may cause an accident such as the user falling over.



Take special care when handling the ND filter or closeup lens included in the optional accessories. Breakage of the ND filter or closeup lens may cause injury.



Take care not to get your hand caught in the opening and closing parts of the storage case included in the optional accessories as this may cause an injury.



Keep the instrument's ventilation holes free from obstruction.  
Failure to do so may cause fire.



Unplug the power plug from the AC outlet when cleaning the instrument.  
Failure to do so may cause electric shock.



# Introduction

---

This instrument is a high-accuracy spectroradiometer designed to measure luminance and chromaticity up to super-low luminance regions. Carefully read this manual before using it.

## **Packaging materials**

Be sure to save all packaging materials (corrugated cardboard boxes, pads and plastic bags) supplied with the purchase. This is a precision measuring instrument. Use supplied packaging materials to minimize shocks and vibrations in case this instrument needs to be transported for purposes such as maintenance in KONICA MINOLTA's factories.

Should any of these packaging materials be lost or broken, please contact the nearest

**KONICA MINOLTA-authorized service facility.**

## **Notes on Use**

Be sure to use this instrument properly. Use of this instrument in ways other than those specified in this manual may result in risk of injury, electric shock, instrument damage, or other problems.

## **Operating Environment**

- The AC adapter (AC-A312G) supplied as a standard accessory is designed specifically for use indoors. Do not use it outdoors.
- Do not disassemble this instrument as it is composed of precision electronic components.
- Use this instrument at rated voltage of 100-240 V $\sim$ . Connect the AC power cord to the AC outlet with the rated voltage and frequency of 100-240 V $\sim$  (50/60 Hz). Connected voltage should not be outside the range of  $\pm 10\%$  of nominal.
- This instrument corresponds to a Pollution Degree 2 product (instruments used mainly in manufacturing plants, laboratories, warehouses or equivalents.). Use the instrument in environments not exposed to metallic dust and condensation.
- This instrument corresponds to an Overvoltage Category I product (instruments connected to a circuit with measures taken to limit excessive overvoltage to a suitably low level).
- This instrument and the AC adapter are EMC Class B products. Use of the instrument and the AC adapter in home environments may cause radio interference. Users may be required to take appropriate measures in such cases.
- This instrument complies with Electrical equipment for measurement, control and laboratory use - EMC (Electromagnetic Compatibility) requirements - Part 1: General requirements (EU Harmonized Standards EN 61326-1:2021). Conformity verification is performed under KONICA MINOLTA's test conditions in an INDUSTRIAL ELECTROMAGNETIC ENVIRONMENT specified in the relevant harmonized standards. The limit of performance degradation when subjected to continuous disturbance during immunity testing is up to twice KONICA MINOLTA's repeatability specifications (Lv, x, y).
- Take care not to allow foreign substances like water and metal to penetrate the instrument. Operating it in such a state is extremely dangerous.
- Do not use this instrument in places exposed to direct sunlight or near a heating appliance. Doing so may cause the internal temperature of the instrument to greatly exceed the ambient temperature,

---

which may break the instrument. Also, use the instrument in a well-ventilated place. To ensure proper heat dissipation, keep the ventilation holes free from obstruction.

- Avoid a rapid change in ambient temperature to prevent condensation.
- Avoid using the instrument in extremely dusty or humid places.
- Use the CS-2000Plus at an ambient temperature between 5 and 35°C and relative humidity of 80% or less (at 35°C) with no condensation. Use the CS-3000HDR/CS-3000 at an ambient temperature between 5 and 30°C and relative humidity of 80% or less (at 30°C) with no condensation. Operating the instrument outside the specified temperature and humidity ranges may impede its performance.
- Do not use the instrument at altitudes higher than 2,000 m above sea level.
- Make sure the AC adapter output plug is not short-circuited. A short-circuit may cause fire or electric shock.
- Do not connect the AC adapter to an overloaded electrical circuit. In addition, do not cover or wrap the AC adapter with cloth or any other material while in use. Doing so may cause electric shock or fire.
- When removing the AC adapter from the instrument, first remove the power cord from the outlet, and then remove the output plug.

### **This Instrument**

- Do not subject the instrument to strong impact or vibration.
- Do not forcibly pull, bend, or apply strong force to the power cord for the included AC adapter or USB cable. This may result in the cord snapping.
- Connect the instrument to a power source with minimal noise.
- Do not measure a high-luminance light source (including sunlight) beyond the measurement range. Failure to observe this warning could result in damage to the instrument's optical system.
- Should you notice any breakage or abnormality during operation, immediately switch the power off and unplug the AC adapter. Then refer to "Error Check." p.98
- Should this instrument break down, do not try to disassemble and repair it by yourself. Please contact the nearest **KONICA MINOLTA-authorized service facility**.
- Warm this instrument up for at least 20 minutes after switching the power on when the object luminance is 2 cd/m<sup>2</sup> or lower (measurement angle 1°).
- When not using RS-232C communication, be sure to attach the connector cap. Failure to do so may cause malfunction due to static electricity.

### **Objective Lens, ND Filter, Closeup Lens, and Illuminance Adapter (Optional Accessories)**

- When performing measurements, make sure that the surfaces of the objective lens, ND filter, closeup lens, and illuminance adapter (optional accessories) are clean. Correct measurement may not be performed if there is dirt, dust, fingerprints or parts left unclean.
- Do not touch the surface of objective lens, ND filter, closeup lens or illuminance adapter with your hands.
- When a sudden change in temperature is applied in a high humidity environment, this may mist the objective lens, ND filter, closeup lens or illuminance adapter, resulting in incorrect measurements.
- Please note that observing light of about 100,000 lx with a light source with a large infrared light output, such as an A light source, may cause a large temperature rise inside the illuminance adapter and the main unit, resulting in damage.

---

## Notes on Storage

### Main Unit

- Do not store this instrument in places exposed to direct sunlight or near a heating appliance. Doing so may cause the internal temperature of the instrument to greatly exceed the ambient temperature, leading to malfunction.
- Store this instrument at an ambient temperature between 0 and 35°C and relative humidity of 80% or less (at 30°C) with no condensation. Storage under high temperature and humidity may impede the performance of this instrument, so we recommend storage with a drying agent at room temperature.
- Take care to prevent condensation forming when storing the instrument. Also, when moving the instrument to a location where it will be stored, be careful of sudden temperature changes to avoid condensation.
- Insert the instrument in the packaging box supplied at purchase or the storage case (CS-A30) in the optional accessories and store in a safe place.

### Objective lens

- When storing the objective lens, cover them with the standard accessory lens cap.

## Cleaning

### Main Unit

- If the instrument becomes dirty, wipe it with a dry and soft cloth. Do not use an organic solvent, such as benzene or thinner, or any other chemical agent to clean it. Should none of these methods remove the dirt, please contact the nearest **KONICA MINOLTA-authorized service facility**.

### Objective lens

- Should dirt or dust get on the lens, wipe it off with a dry and soft cloth or lens cleaning paper. Do not use an organic solvent, such as benzene or thinner, or any other chemical agent to clean it. Should the dirt be difficult to remove, please contact the nearest **KONICA MINOLTA-authorized service facility**.

## Notes on Transporting

- Use the packaging material supplied at purchase to minimize vibration or shocks generated while transporting the instrument.
- Put all materials including the main unit and accessories in the original packaging material when returning the instrument for servicing.

## Maintenance

- Periodic maintenance is recommended annually to maintain measurement accuracy of the instrument. For details on maintenance, please contact the nearest **KONICA MINOLTA-authorized service facility**.

## Disposal Method

- Make sure that the main unit, its accessories and the packing materials are either disposed of or recycled correctly in accordance with local laws and regulations.

# Contents

---

<b>Safety Symbols</b> .....	<b>ii</b>
<b>Introduction</b> .....	<b>3</b>
<b>Notes on Use</b> .....	<b>3</b>
Operating Environment .....	3
This Instrument.....	4
Objective Lens, ND Filter, Closeup Lens, and Illuminance Adapter (Optional Accessories).....	4
<b>Notes on Storage</b> .....	<b>5</b>
Main Unit.....	5
Objective lens.....	5
<b>Cleaning</b> .....	<b>5</b>
Main Unit.....	5
Objective lens.....	5
<b>Notes on Transporting</b> .....	<b>5</b>
<b>Maintenance</b> .....	<b>5</b>
<b>Disposal Method</b> .....	<b>5</b>
<b>Standard Accessories</b> .....	<b>8</b>
<b>Optional Accessories</b> .....	<b>9</b>
<b>System Configuration</b> .....	<b>11</b>
<b>Names and Functions of Parts</b> .....	<b>12</b>
<b>Names of Each Part</b> .....	<b>12</b>
<b>Functions of Each Part</b> .....	<b>13</b>
<b>Key Panel</b> .....	<b>14</b>
<b>Main Functions of Each Key</b> .....	<b>14</b>
<b>Diopter Adjustment</b> .....	<b>15</b>
<b>LCD Screen</b> .....	<b>16</b>
MEAS (Measurement Value) Screen .....	16
MENU Screen .....	17

## Installation

<b>Installing</b> .....	<b>20</b>
<b>Connecting AC Adapter</b> .....	<b>21</b>
<b>Connection Method</b> .....	<b>22</b>
<b>Power supply ON (I) / OFF (O)</b> .....	<b>23</b>
Turning Power Switch ON .....	23
Turning Power Switch OFF .....	24

## Setting

<b>Selecting Measurement Speed</b> .....	<b>26</b>
<b>Setting of Synchronization</b> .....	<b>31</b>
<b>Emission Frequency Detection and Setting     Function (CS-3000HDR/CS-3000 only)</b> .....	<b>34</b>
<b>Vertically Synchronized Signal Input     Method</b> .....	<b>36</b>
<b>Selecting Synchronous Frames</b> .....	<b>38</b>
<b>Selecting Measurement Angle</b> .....	<b>40</b>
<b>Selecting Color Matching Functions</b> .....	<b>42</b>
<b>Selecting Display Format</b> .....	<b>44</b>
<b>Process Settings for Negative Spectral     Radiance Values</b> .....	<b>46</b>
<b>Selecting Color Space</b> .....	<b>48</b>
<b>Using the Closeup Lens</b> .....	<b>50</b>
<b>Using the ND Filter</b> .....	<b>52</b>
<b>Using the Illuminance Adapter</b> .....	<b>54</b>
<b>Backlight ON/OFF During     Measurement</b> .....	<b>56</b>
<b>Baud Rate Selection for RS-232C     Communication</b> .....	<b>58</b>
<b>Setting RS-232C Power Supply</b> .....	<b>60</b>
<b>Setting Internal Clock</b> .....	<b>62</b>
<b>Setting Periodic Calibration Reminders</b> .....	<b>64</b>

---

<b>Calibration.....</b>	<b>66</b>
<b>Calibration Channels .....</b>	<b>66</b>
<b>Checking Main Unit Information .....</b>	<b>68</b>

<b>Setting Initialization .....</b>	<b>101</b>
<b>Main Specifications.....</b>	<b>102</b>

<b>Measurement</b>
--------------------

<b>Measurement .....</b>	<b>70</b>
<b>Saving Measurement Values.....</b>	<b>73</b>
<b>Confirming Memory Data .....</b>	<b>76</b>
<b>Deleting Memory Data .....</b>	<b>77</b>

<b>Communication</b>
----------------------

<b>Connecting to a PC .....</b>	<b>82</b>
<b>Connection via USB cable.....</b>	<b>82</b>
<b>Connection via RS-232C cable.....</b>	<b>83</b>
<b>Connection via RS-232C Bluetooth     Conversion Adapter .....</b>	<b>84</b>
<b>Remote Mode .....</b>	<b>85</b>

<b>Explanation</b>
--------------------

<b>Measurement Principles.....</b>	<b>88</b>
Sensor Section .....	88
<b>Dark Measurement .....</b>	<b>89</b>
Dark measurement modes.....	89
Performing Dark Measurement.....	90
<b>LvTcp<math>\Delta</math>uv .....</b>	<b>91</b>
<b>Dominant Wavelength/ Excitation Purity .....</b>	<b>92</b>
<b>Dimensions.....</b>	<b>93</b>
<b>Error Messages .....</b>	<b>96</b>
<b>Caution Messages .....</b>	<b>97</b>
<b>Error Check.....</b>	<b>98</b>

# Standard Accessories

Standard and optional accessories are available with the instrument.

**Memo** The shapes of some products may be different from those shown.

## Lens Cap CS-A31

- Attach it to the objective lens to protect them when not using this instrument.

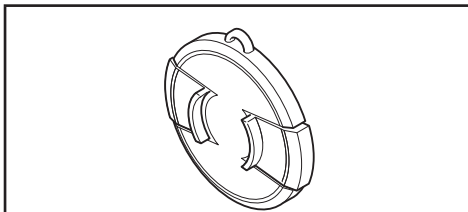

## USB Cable (2 m) CS-A32

- Used for communication between the instrument and a PC.

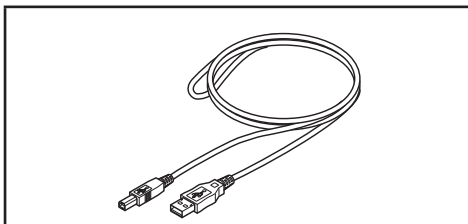

## AC Adapter AC-A312G (ATS036T-A120)

- Supplies power from the AC outlet.  
Input: 100 V - 240 V~ 50/60 Hz 1 A Max  
Output: 12 V  $\equiv$  3 A  
Plug design  $\oplus$   $\ominus$   $\ominus$  Center-negative

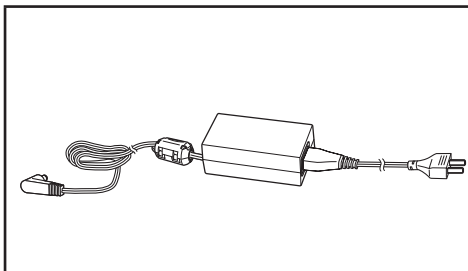

## Screw for focus ring lock CS-A38

- Locks the focus adjustment ring so that it does not move unintentionally.
  - **Tighten included screw by hand. Using a tool may tighten this screw with excessive force, damaging it.**
  - Do not use any screw other than the provided one. Should it get lost or damaged, purchase a new CS-A38 screw.
  - When shipped from the factory, this screw holds the focus adjustment ring in place. To move the focus adjustment ring, loosen this screw.
  - When storing the CS-3000HDR/CS-3000/CS-2000Plus in the Storage Case (optional accessory), remove this screw or position it so that it does not hit the packing material.
  - When inserting the CS-3000HDR/CS-3000/CS-2000Plus in the packaging for transportation, remove this screw or position it so that it does not hit the packing material.

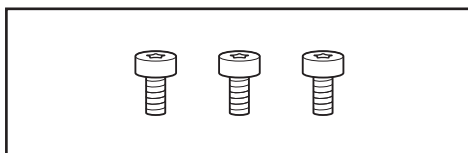

## Calibration Certificate

### Software for Spectroradiometers



#### CS-S30

- This software allows the instrument to be controlled and perform versatile data management from a PC.
- Software can be downloaded from <https://www.konicaminolta.com/instruments/download/software/display/index.html>.



# Optional Accessories

---

## ND Eyepiece Filter CS-A1

- Reduces glare when looking through the finder to measure high-luminance objects. When measuring a high-luminance object, be sure to place it in front of the finder.

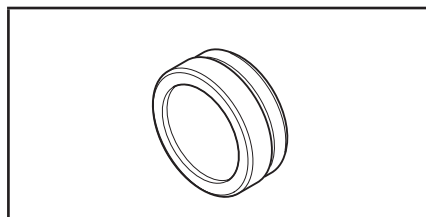

## ND Eyepiece Filter (for high luminance) CS-A39

- In particular, the CS-3000HDR has a measurement range on the high-luminance side that is 20 times wider than that of the CS-3000/CS-2000Plus, so when measuring a high-luminance object, be sure to place this filter in front of the finder.

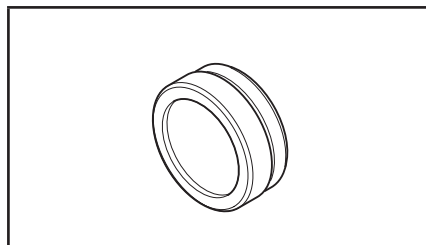

## ND Filter (1/10) CS-A40

### ND Filter (1/100) CS-A41

- Placed in front of the objective lens for measurement of high luminance objects.

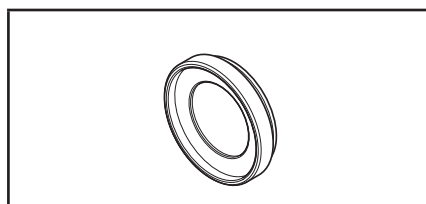

## Calibration Certificate (for ND filter)

- Calibration certificates can be attached to the ND filters (1/10) CS-A40, ND filters (1/100) and CS-A41.

## Closeup Lens CS-A42

- Placed in front of the objective lens for measurement of microscopic objects.

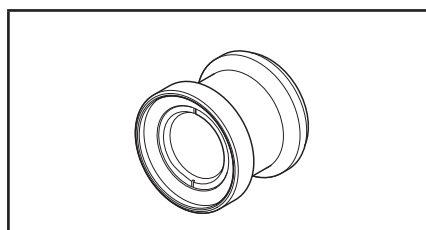

## Adapter for CCD camera CS-A36

- Placed between the finder and the main unit when a C-mount industrial camera is used.

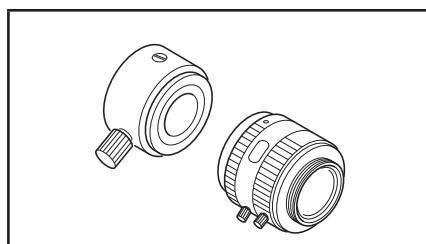

## Illuminance Adapter CS-A43

- Placed in front of the objective lens when measuring illuminance.

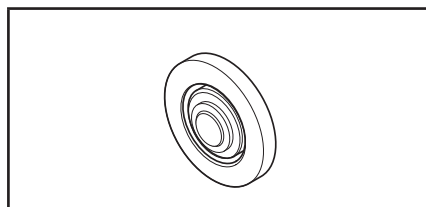

---

**White Calibration Plate CS-A5 (without data)**

**White Calibration Plate CS-A5 (with data)**

**White Calibration Plate CS-A5 (with data and calibration certificate)**

- Used for measurement of object colors. Three types (named, not-named, named with calibration certificate) are prepared.

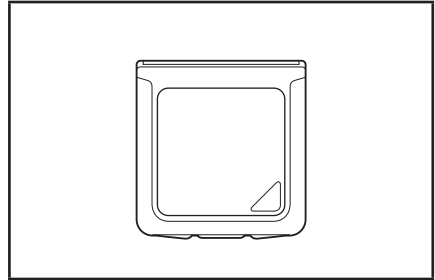

**Tripod CS-A3**

**Pan Head CS-A4**

- Used when installing this instrument.

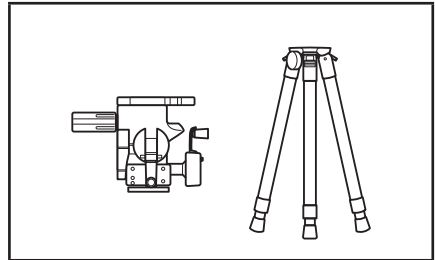

**Storage Case CS-A30**

- Used to store the instrument and accessories or to house them when carrying by hand. Never use this for transporting the instrument.

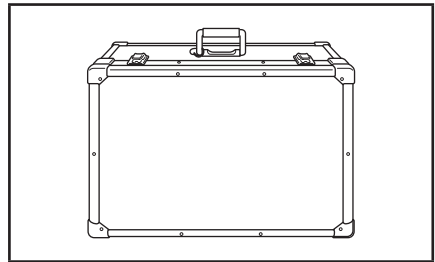

**RS-232C cable (5 m)**

**IF-A37**

**RS-232C cable (10 m)**

**IF-A38**

- Used to connect the instrument to the RS-232C interface on a PC.

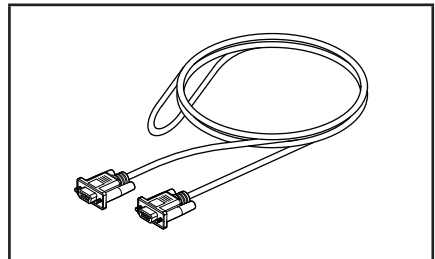



# System Configuration

———— Standard Accessories

- - - - - Optional Accessories

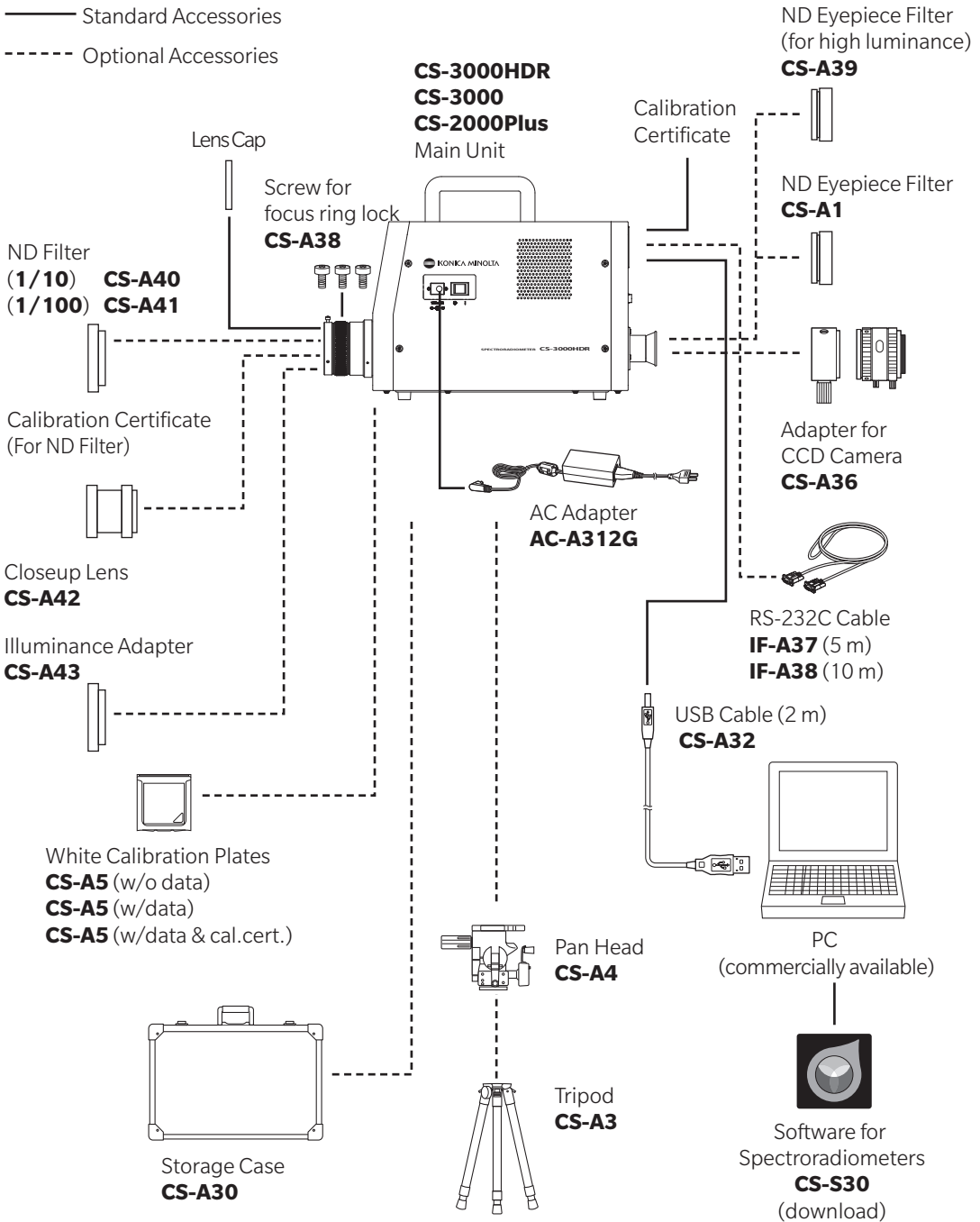

# Names and Functions of Parts

## Names of Each Part

- CS-3000HDR/CS-3000/CS-2000Plus

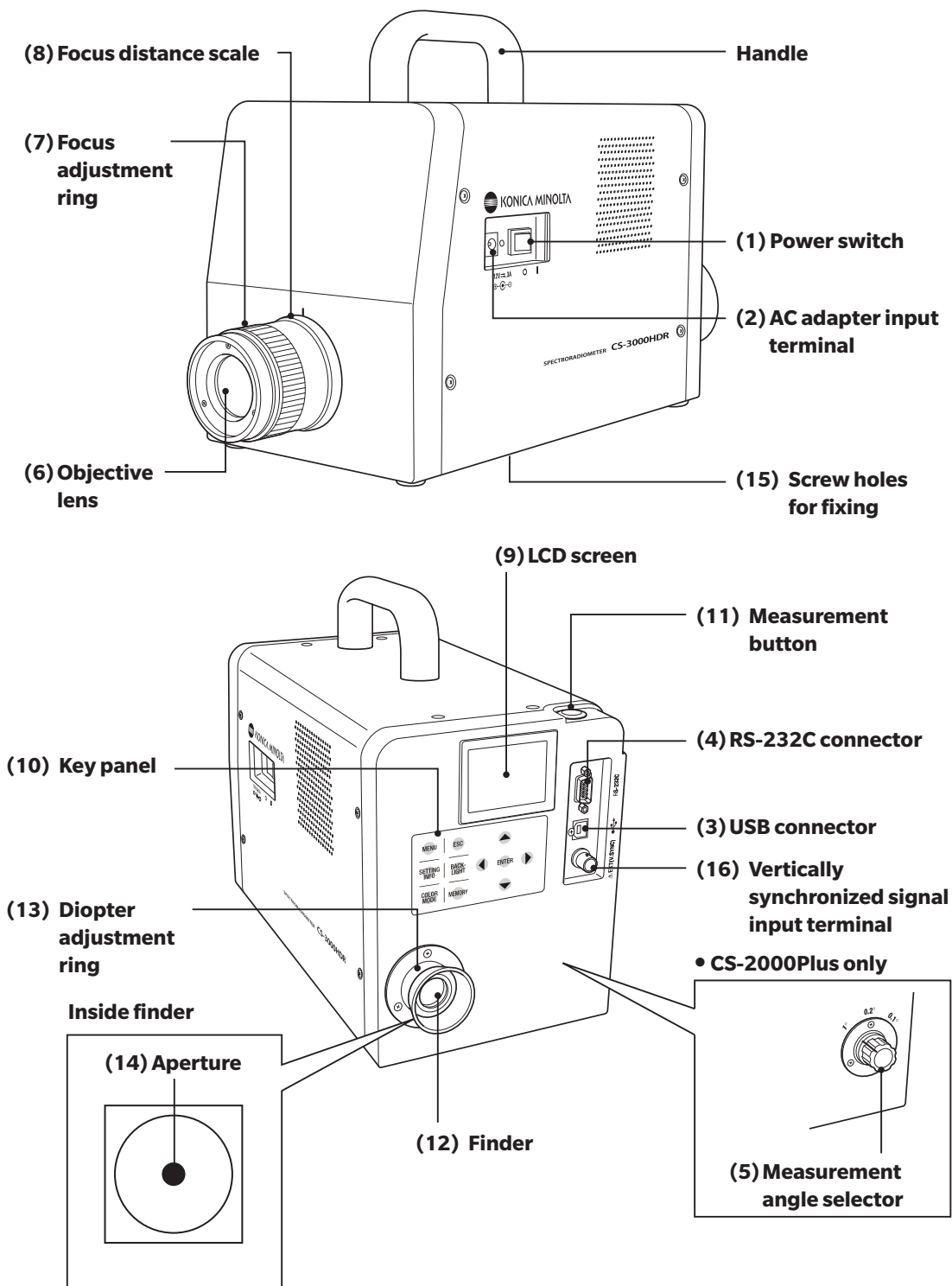

## Functions of Each Part

- (1) **Power switch** Switches this instrument on/off. ( | ) for ON; ( O ) for OFF. .... (p.23)
- (2) **AC adapter input terminal** Connects the attached AC adapter. .... (p.21)
- (3) **USB connector** Connects the USB cable when connecting to a PC. .... (p.82)
- (4) **RS-232C connector** Connects the RS-232C cable when connecting to a PC. .... (p.83)
- (5) **Measurement angle selector** Selects measurement angle from among 1°, 0.2° and 0.1°. .... (p.40)  
CS-2000Plus only. For the CS-3000HDR/CS-3000, the measurement angle is switched electrically according to the selection made on the MENU screen.
- (6) **Objective lens** Performs measurement by pointing this part toward the object for measurement. .... (p.71)
- (7) **Focus adjustment ring** Adjusts focus of objective lens when measuring. .... (p.71)
- (8) **Focus distance scale** Used as a guide for the focus position. .... (p.71)
- (9) **LCD screen** Displays various screens like measurement and menu. .... (p.16)
- (10) **Key panel** Offers several keys for operation of this instrument. .... (p.14)
- (11) **Measurement button** Used for measurement. .... (p.71)
- (12) **Finder** Used to observe objects for measurement. .... (p.15, 70)
- (13) **Diopter adjustment ring** Adjusts the diopter. .... (p.15, 70)
- (14) **Aperture** Indicates measurement area. .... (p.15, 70)  
Size of black circle will change depending on the measurement angle.

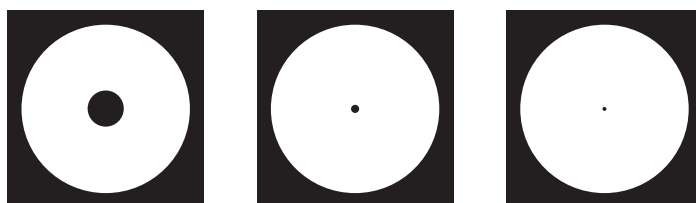

**Measurement angle 1°    Measurement angle 0.2°    Measurement angle 0.1°**









- (15) **Screw holes for fixing** Used to fix this instrument to a tripod or jig. .... (p.20)
- (16) **Vertically synchronized signal input terminal** Connects the cable to input the vertically synchronized signal at the external sync measurement. .... (p.31)

---

## Key Panel



## Main Functions of Each Key

- (1) MENU key** Switches to the MENU screen if pressed while the measurement value screen is displayed. (p.17)
- (2) SETTING INFO key** Displays the current MEAS, OPTION, and SETUP settings if pressed while the measurement value screen is displayed. (p.71)
- (3) COLOR MODE key** Color space modes are switched in turn as follows, by pressing this key while the measurement value screen is displayed:  $L_vxy \rightarrow L_vu'v' \rightarrow L_vT_{cp}\Delta uv \rightarrow XYZ \rightarrow$  Dominant wavelength/Excitation purity  $\rightarrow$  Spectral graph  $\rightarrow L_vxy$ . (p.48)
- (4) ESC key** If this key is pressed while the MENU screen is displayed, the settings are canceled and the measurement value screen appears again. If pressed during numerical input or when making each setting, the settings are canceled. If pressed during continuous measurement, the measurement ends.
- (5) BACKLIGHT key** Selects backlight ON/OFF on the LCD screen. Pressing the BACKLIGHT key switches the light in the following order: On (light)  $\rightarrow$  On (dark)  $\rightarrow$  Off  $\rightarrow$  On (light), and so on.
- (6) MEMORY key** Measured data is stored in the memory by pressing this key while the measurement value screen is displayed. (p.73)
- (7)   keys** Memory data, calibration channels, etc., are changed by pressing these keys while the screen for displaying various data is displayed. The cursor position is moved up and down, or the values and set items are changed, by pressing the key during numerical input or when making each setting.
- (8)   keys** The cursor position moves right and left by pressing these keys during numerical input or when making each setting.
- (9) ENTER key** Press this key to confirm the contents selected by    .

---

## Diopter Adjustment

Rotate the finder's diopter adjustment ring to adjust the diopter.

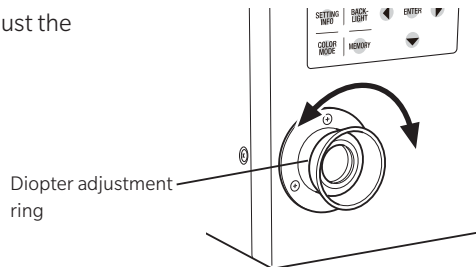

Adjust so that A or B on the aperture (black circle indicating measurement area) looks clear when observing the measurement object through the finder. Adjustment is easier by starting at the measurement angle  $1^\circ$ , where the measurement object near the aperture looks blurred.

Make sure to adjust the diopter before measurement. The diopter should be adjusted by the person taking the measurement. If the diopter is not adjusted before focus measurement, the correct measurement value may not be obtained. This is because the focus is actually off even though you may think it is correctly in focus. In addition, if the diopter is not correctly adjusted, the aperture may look like it is moving depending on the viewing angle.

\* You may see small black dots or stripes inside the finder, but this has no effect on the measurement performance.

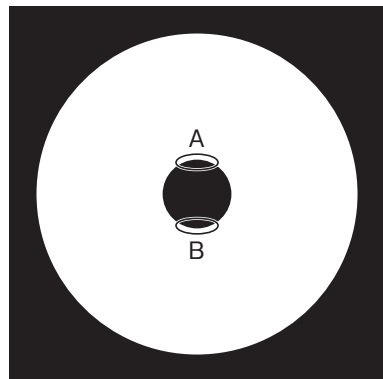

# LCD Screen

## MEAS (Measurement Value) Screen

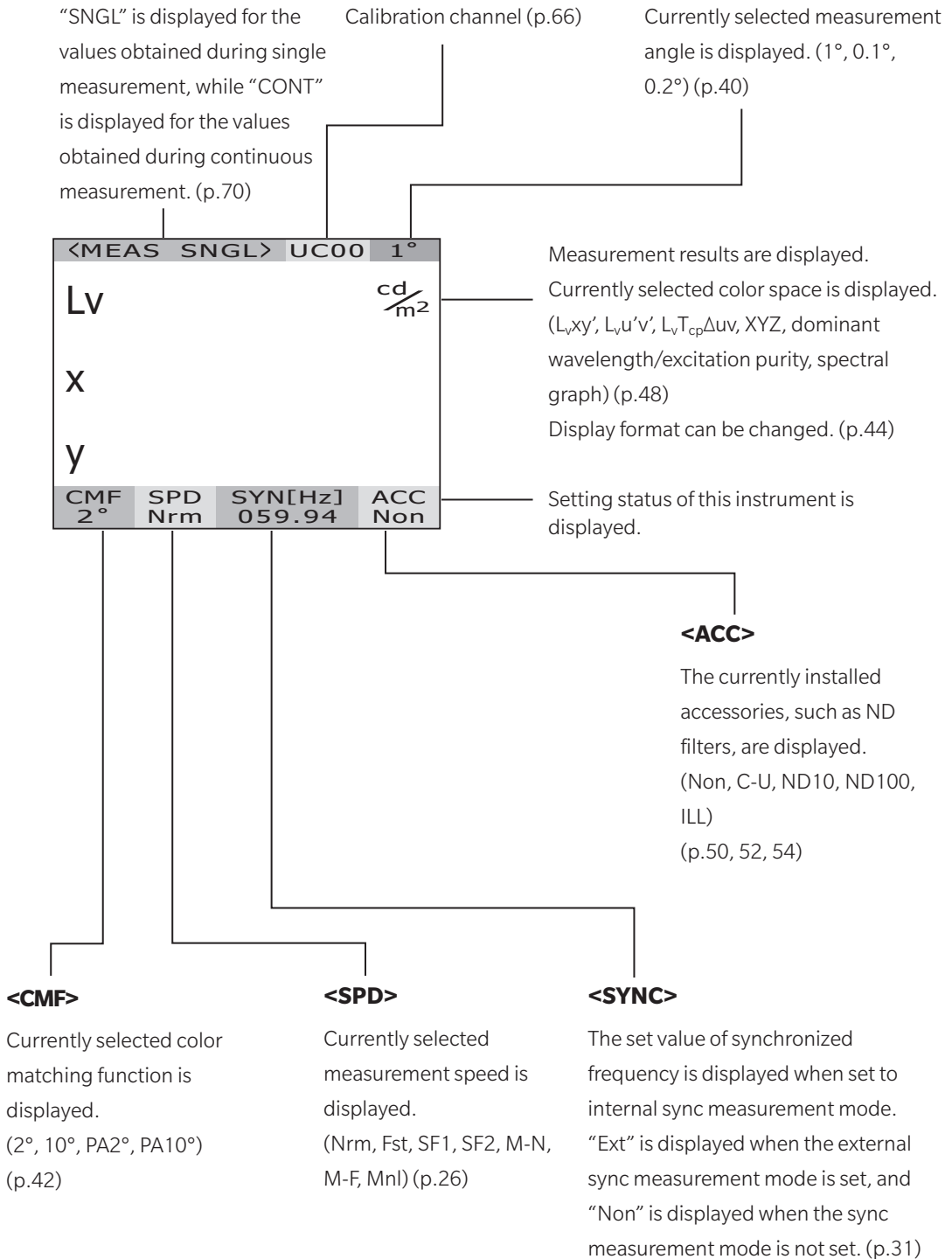

---

## **MENU Screen**

Switches to the MENU screen if **MENU** key is pressed while the measurement value screen is displayed.

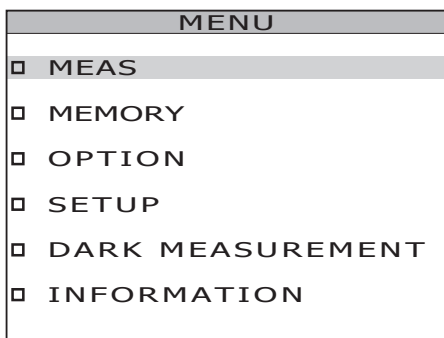

### **MEAS**

Used to set measurement speed or synchronizing method. (p.26, 31)

### **MEMORY**

Used to read or delete the saved measurement values. (p.74, 77)

### **OPTION**

Used to set the closeup lens, ND filter, illuminance adapter or calibration channel. (p.50, 52, 54, 66)

### **SETUP**

Used to set the color matching functions, backlight, display format, and communication settings. (p.42, 56, 44, 58)

### **DARK MEASUREMENT**

Performs dark measurement. (p.89)

### **INFORMATION**

Instrument information such as product name, product serial number, and main unit version are displayed. (p.68)





# Installation

# Installing

The screw holes for fixing at the bottom of this instrument can be used for mounting this instrument on a tripod or jig.

The instrument has the following two types of holes.

**Tripod screw hole:** Used to mount the instrument on a tripod. Use a tripod screw with top diameter of 3/8 inches and depth of 10.5 mm.

[Note] The tripod screw holes correspond with the 3/8-inch screws of a large camera tripod. 1/4-inch screws cannot be used for fixing this instrument.

**ISO screw hole:** Used to mount the instrument on a jig. Use ISO screws with top diameter of 5 mm and depth of 6.5 mm.

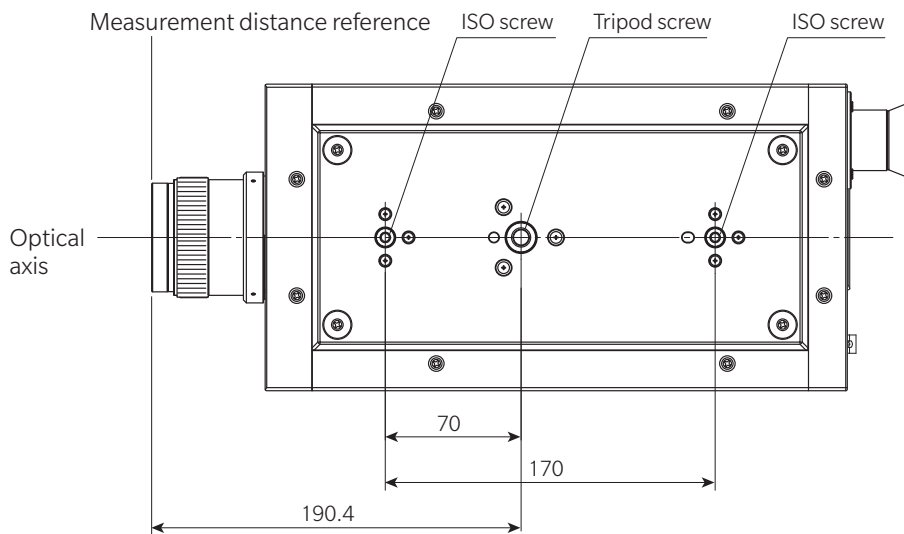

For other detailed dimensions, see p.93, 94, 95.

# Connecting AC Adapter

The AC adapter supplied with this instrument is used for the corresponding power source.



## **Warning** (Failure to adhere to the following points may result in death or serious injury)



Always use the AC adapter and power cord supplied as a standard or optional accessory (AC-A312G), and connect it to an indoor AC outlet of rated voltage and frequency (100 V $\sim$ , 50 Hz/60 Hz). Failure to follow either of these may result in damage to the instrument or the AC adapter, fire or electric shock.



If this instrument is not used for a long time, disconnect the AC adapter from the AC outlet. Accumulated dirt or water on the prongs of the AC adapter may cause fire. Accumulated dirt or water on the prongs of the AC adapter may cause fire and should be removed.



When unplugging the power cord of the AC adapter, gently unplug it by holding the power plug. Do not forcibly pull the power cord when unplugging as this may damage it or cause fire or electric shock. Also, do not handle the power cord with wet hands. Doing so may cause electric shock.



Do not forcibly bend, twist or pull the power cord. Also, do not place heavy objects on the power cord, or damage or modify it. Such actions may cause fire or electric shock due to damage to the power cord.



Do not disassemble or modify this instrument or the AC adapter. Doing so may cause fire or electric shock.



Should this instrument or the AC adapter be damaged or emit smoke or an odd smell, do not keep using such instrument or AC adapter without correction. Doing so may cause fire. In such situations, immediately switch the power off and unplug the AC adapter, and then contact the nearest KONICA MINOLTA-authorized service facility.



## **Caution** (Failure to adhere to following points may result in injury or damage to this instrument or other properties)



Use the instrument near an AC outlet so that the AC adapter can be easily plugged and unplugged.

## Connection Method

1. Make sure that power switch is OFF (Slid to [O] side).

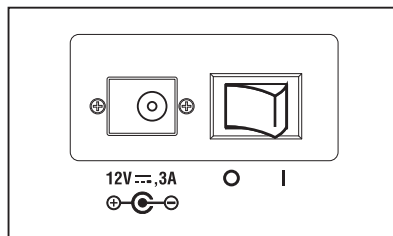

2. Connect the AC adapter plug to the AC adapter input terminal of the main unit.

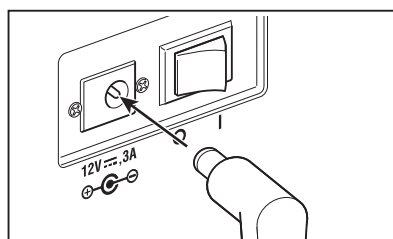

3. Plug the AC adapter to the outlet (AC 100 V~ 50 Hz/60 Hz).

Fully insert the AC adapter plug until it is securely seated in the AC outlet.

The AC adapter has an LED window that lights up a fade green when the power switch of the unit is ON (|). If the object to be measured is a very low luminance light source, this LED lighting may affect the measured value. To eliminate this effect, attach the included light-shielding sticker to the AC adapter.

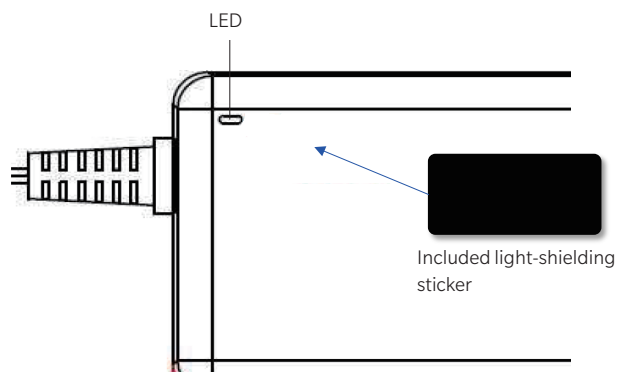

# Power supply ON ( | ) / OFF ( O )

The warm-up time needed is a minimum of 20 minutes to measure objects with excellent accuracy under the conditions described below. Warm up this instrument for 20 or more minutes when the power source is turned off even for a short period, and turned on again.

- (1) For the object of a low-luminance light source using 2856 K (standard light source A) as a guide:
- 2 cd/m<sup>2</sup> or lower (Measurement angle 1°)
  - 50 cd/m<sup>2</sup> or lower (Measurement angle 0.2°)
  - 200 cd/m<sup>2</sup> or lower (Measurement angle 0.1°)
- (2) When room temperature and humidity of the measurement environment does not fall under the normal temperature and humidity ranges

## Turning Power Switch ON

### Slide power switch to ON ( | ) side.

- ◆ The measurement screen appears about 5 to 15 seconds after the initial screen on the LCD.
- ◆ The model type (CS-3000HDR/CS-3000 or CS-2000Plus) and main unit version are displayed on the initial screen. The model type can also be confirmed on the nameplate.

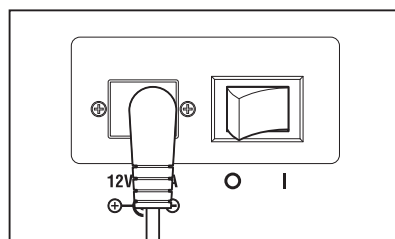



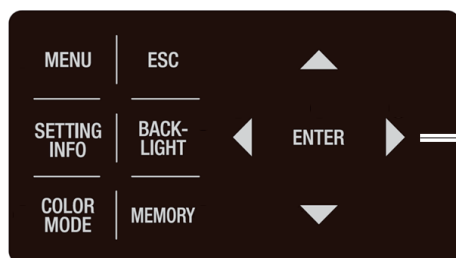
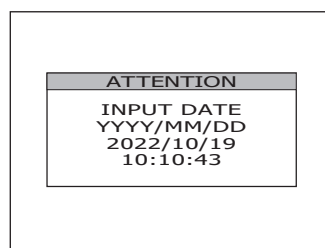

### When turning on the power for the first time

The internal clock setting screen is displayed. Check the date and time, and if there is a discrepancy, enter the correct date and time.

\* Factory default setting: Time adjusted at time of shipment, Display format: YYYY/MM/DD



1, 2, 3





1. Press either  or  key to move the cursor. Press either  or  key to set date and then press **ENTER** key.

Press  key for a larger number.

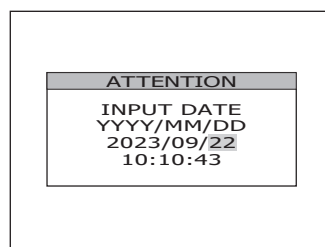
Press  key for a smaller number.

The cursor moves to the time setting.



- 2. Press either  or  key to move the cursor.**  
**Press either  or  key to set time (hh:mm:ss) and then press **ENTER** key.**



Press  key for a larger number.

Press  key for a smaller number.

See p.62 to change the setting at a later time.

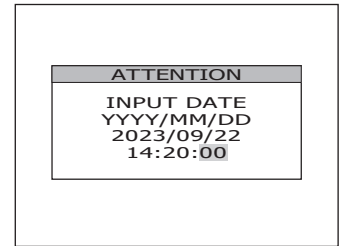
The periodic calibration reminders setting screen is displayed.



- 3. Press either  or  key to move the cursor.**  
**Move the cursor to [YES] or [NO] and press **ENTER** key.**

For more information on setting periodic calibration reminders, see Setting Periodic Calibration Reminders on p. 64.

If the power is turned off while setting the internal clock, the setting for periodic calibration reminders will be set to NO (OFF).

See p.64 to change the setting at a later time.

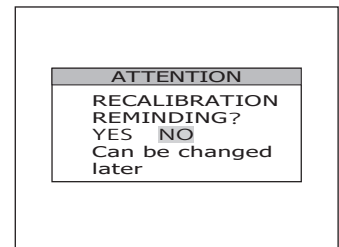

## **Turning Power Switch OFF**

**To turn off the main unit after measurement is finished, slide power switch to OFF (O) side.**

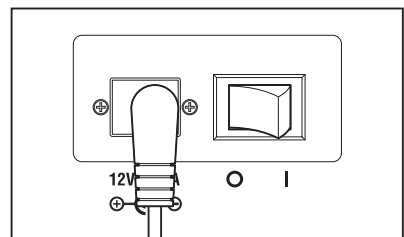

# Setting

# Selecting Measurement Speed

Select measurement speed according to the purpose. The following seven modes are available for measurement speed.

Measurement speed	Operation description	Dark measurement <sup>2</sup>	Features	Cautions	Example of measurement subjects
NORMAL	In this mode, integration time <sup>1</sup> is adjusted between 0.005 and 92 seconds (120 seconds for CS-2000Plus) according to the brightness of the measurement subject. This mode emphasizes performance for low luminance measurement.	[STANDARD DARK]	Improved accuracy and repeatability for luminance below approx. 4 cd/m <sup>2</sup> (measurement angle: 1°)	For low luminance measurement, since the total measurement time can be as long as 4 minutes, the measurement results will be the average luminance if the brightness of the measurement subject changes. In addition, take care not to move the instrument during measurement. When measuring flickering light sources, the MULTI INTEG-NORMAL mode or the MULTI INTEG-FAST mode may be more suitable, for example, when the synchronized frequency is unknown.	Constant light sources (halogen lamps, etc.) Flickering light sources (which are stable and whose synchronization frequency is known)
FAST	In this mode, integration time is adjusted between 0.005 and 16 seconds according to the brightness of the measurement subject.	[STANDARD DARK]	Shorter time for low luminance measurement below approx. 4 cd/m <sup>2</sup> (measurement angle: 1°)	When higher accuracy and repeatability are required at low luminance, the NORMAL mode should be used if necessary.	Same as above
SUPER-FAST1	In this mode, integration time is adjusted according to the brightness of the measurement subject. Reduces measurement integration time to about 5% of the time needed in the NORMAL mode.	[INTELLIGENT DARK]	Shorter measuring time	When higher accuracy and repeatability are required at low luminance, the NORMAL or FAST mode should be used if necessary.	Same as above
SUPER-FAST2	In this mode, integration time is adjusted according to the brightness of the measurement subject. Reduces measurement integration time to about 1% of the time needed in the NORMAL mode.	[INTELLIGENT DARK]	Shorter measuring time	When higher accuracy and repeatability are required at low luminance, the NORMAL or FAST mode should be used if necessary.	Same as above
MULTI INTEG-NORMAL	In this mode, several cycles of the integration time for the NORMAL mode are taken and averaged. Under luminance conditions which require an integration time longer than the set luminance, the integration time will be the same as for the NORMAL measurement. This mode can be used to measure flickering light sources when the synchronization frequency is unknown or when the synchronization frequency is known but the frequency is unstable. In such case, the synchronization mode should be set to [NO SYNC].	[STANDARD DARK]	Measurements which do not depend on the synchronization frequency of the measurement subject can be taken.  Improved accuracy and repeatability for luminance below approx. 4 cd/m <sup>2</sup> (measurement angle: 1°)	Even for high luminance, the set integration time (1 second or longer) will be used.	Flickering light sources (which are unstable and whose synchronization frequency is unknown)
MULTI INTEG-FAST	In this mode, several cycles of the integration time for the FAST mode are taken and averaged. Under luminance conditions which require an integration time longer than the set luminance, the integration time will be the same as for the FAST measurement. This mode can be used to measure flickering light sources when the synchronization frequency is unknown or when the synchronization frequency is known but the frequency is unstable. In such case, the synchronization mode should be set to [NO SYNC].	[STANDARD DARK]	Measurements which do not depend on the synchronization frequency of the measurement subject can be taken.  Shorter time for low luminance measurement below approx. 4 cd/m <sup>2</sup> (measurement angle: 1°)	Even for high luminance, the set integration time (1 second or longer) will be used.	Flickering light sources (which are unstable and whose synchronization frequency is unknown)
MANUAL	This mode can be used when you want to set a fixed integration time for measurements. Integration time: 0.005 to 92 seconds (120 seconds for CS-2000Plus)	[STANDARD DARK]	The desired fixed integration time can be set.	Take care to ensure that the "OVER" error message does not occur and that measurement accuracy is not reduced.	All light sources

\*1 Time for the sensor to measure light, indicating "exposure time." On the other hand, measurement time shows time for integration + dark measurement time + time to open/close shutter + time for calculation, indicating time needed for actual measurement.

\*2 For details on dark measurement, refer to p.89. Dark measurements set for each mode of measurement speed can be changed in the measurement software.

\* Factory default setting: NORMAL, IN-ND: AUTO



## Operating Procedure

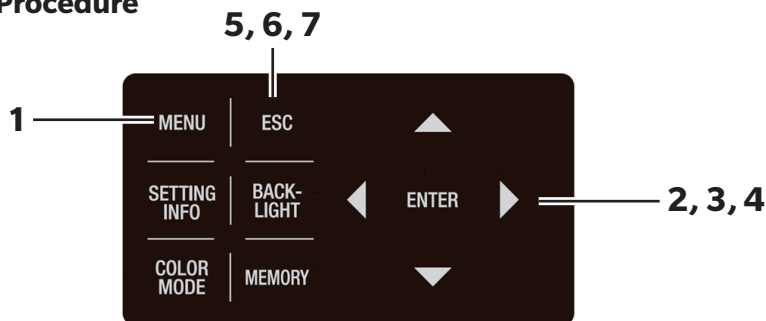

1. Press **MENU** key when the MEAS screen is displayed.

The **MENU** screen appears on the LCD.

When the backlight of the LCD has been turned off via **BACKLIGHT** key on the MEAS screen, the backlight is turned on.

<MEAS SNGL> UC00 1°			
Lv	49.66	cd/m <sup>2</sup>	
X	0.4045		
Y	0.4088		
CMF	SPD	SYN[Hz]	ACC
2°	Nrm	59.94	Non
MENU			
□ MEAS			
□ MEMORY			
□ OPTION			
□ SETUP			
□ DARK MEASUREMENT			
□ INFORMATION			

2. Press either **▲** or **▼** key to select **[MEAS]** and then press **ENTER** key.

The **MENU - MEAS** screen appears on the LCD.

The current set contents are displayed in the **[SPEED]** item.

MENU	
MEAS	
□	SPEED [NORMAL]
□	SYNC [INT SYNC]
□	SYNC FRAME [DOUBLE FRAME]
□	ANGLE [1°]
□	

3. Press either **▲** or **▼** key to select **[SPEED]** and then press **ENTER** key.

The **MENU - MEAS - SPEED MODE (measurement speed setting)** screen appears on the LCD.

MENU	
MEAS	
SPEED MODE(1/2)	
□	■ NORMAL
□	□ FAST
□	□ SUPER-FAST1
□	□ SUPER-FAST2
□	

4. Press either **▲** or **▼** key to select measurement speed.

MENU	
MEAS	
SPEED MODE(1/2)	
□	■ NORMAL
□	□ FAST
□	■ SUPER-FAST1
□	□ SUPER-FAST2
□	

.....

For the NORMAL, FAST, SUPER-FAST1 or SUPER-FAST2 setting

**4-a-1. Select either [NORMAL], [FAST], [SUPER-FAST1] or [SUPER-FAST2] and press **ENTER** key.**

The **MENU - MEAS - SPEED MODE - IN-ND** screen appears on the LCD.

This screen is used to determine whether the ND filter built into the main unit is used or not.

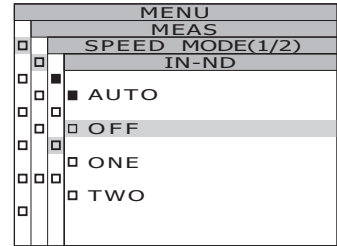

**4-a-2 Press either **▲** or **▼** key to select [AUTO], [OFF], [ONE] or [TWO]\*.**

\* [TWO] can only be selected with CS-3000HDR.

If the **“OVER”** error message appears when set to [OFF], set **IN-ND** to [ONE] or [TWO].

When measuring objects that have a wide range of luminance under the adjusted measurement conditions (ex.  $\gamma$  measurement), set IN-ND to [OFF], or to [ONE] or [TWO]. For [OFF] or [ONE]/[TWO], select [OFF] when the upper limit luminance is up to 100 cd/m<sup>2</sup>, or [ONE] if it is 100 to less than 5,000 cd/m<sup>2</sup>, or [TWO] if it is 5,000 to 100,000 cd/m<sup>2</sup>.

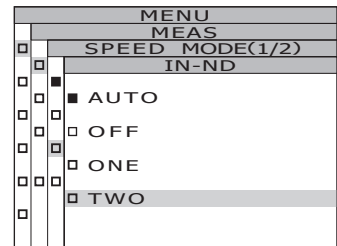

**4-a-3. Press **ENTER** key.**

When the setting is confirmed, the **MENU - MEAS - SPEED MODE** screen appears again on the LCD.

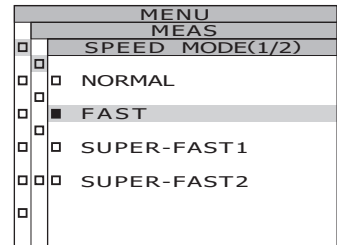

.....

For the MULTI-NORMAL or MULTI-FAST setting

**4-b-1. Select either [MULTI-NORMAL] or [MULTI-FAST] and press **ENTER** key.**

The **MENU - MEAS - SPEED MODE - MULTI-INTEG** screen appears on the LCD.

This screen is used for input of the integration time in the MULTI INTEG-NORMAL mode or the MULTI INTEG-FAST mode.

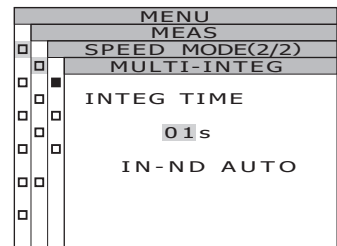

**4-b-2. Press either **▲** or **▼** key to set a value.**

Press **▲** key for a larger number.

Press **▼** key for a smaller number.

The setting range of integration time is from 1 to 16 seconds.

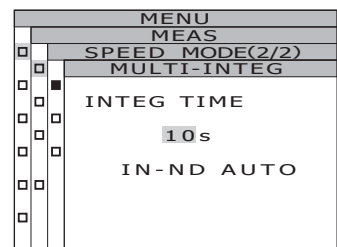

#### 4-b-3. Press **ENTER** key.

The cursor moves to the **IN-ND** item.

This screen is used to determine whether the ND filter built into the main unit is used or not.

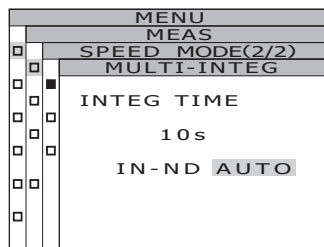

#### 4-b-4. Press either **▲** or **▼** key to select **[AUTO]** / **[OFF]** or **[ONE]** / **[TWO]**\*.

\* [TWO] can only be selected with CS-3000HDR.

If the **"OVER"** error message appears when set to **[OFF]**, set **IN-ND** to **[ONE]** or **[TWO]**.

When measuring objects that have a wide range of luminance under the adjusted measurement conditions (ex.  $\gamma$  measurement), set **IN-ND** to **[OFF]**, or to **[ONE]** or **[TWO]**. For **[OFF]** or **[ONE]/[TWO]**, select **[OFF]** when the upper limit luminance is up to  $100 \text{ cd/m}^2$ , or **[ONE]** if it is  $100$  to less than  $5,000 \text{ cd/m}^2$ , or **[TWO]** if it is  $5,000$  to  $100,000 \text{ cd/m}^2$ .

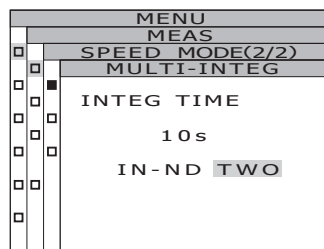

#### 4-b-5. Press **ENTER** key.

When the setting is confirmed, the **MENU - MEAS - SPEED MODE** screen appears again on the LCD.

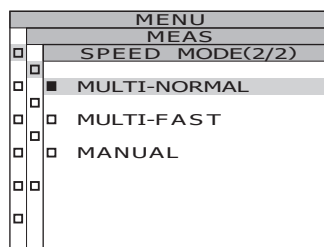

.....

For the **MANUAL** setting

#### 4-c-1. Select **[MANUAL]** and press **ENTER** key.

The **MENU - MEAS - SPEED MODE - MANUAL** screen appears on the LCD. This screen is used to input the integration time in the **MANUAL** mode.

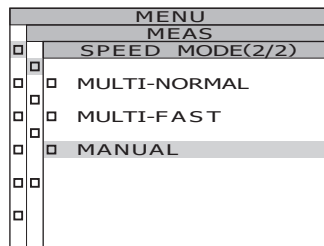

#### 4-c-2. Press either **▲** or **▼** key to set a value.

Press **▲** key for a larger number.

Press **▼** key for a smaller number.

The setting range of integration time is from  $5$  to  $120,000 \text{ ms}$ .

The significant figures for integration time are 6 digits. However, in the case of CS-2000Plus, the actual integration time when the integration time is 4 seconds or more will be an integral multiple of 4 seconds.

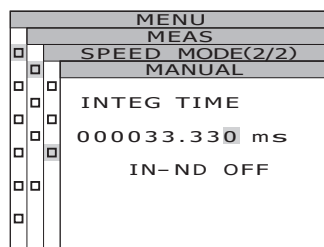
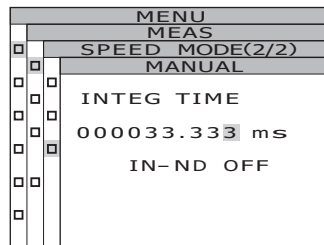

**4-c-3.** Press either  or  key to move the cursor.

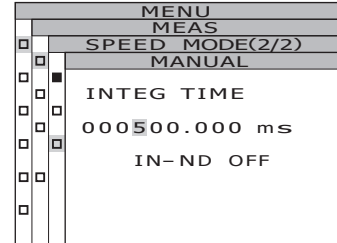

**4-c-4.** Repeat the procedures of 4-c-2. and -3. for the required number of digits.

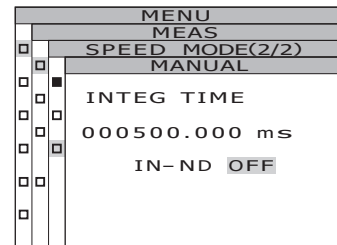

**4-c-5.** Press **ENTER** key.  
The cursor moves to the **IN-ND** item.

This screen is used to determine whether the ND filter built into the main unit is used or not.



**4-c-6.** Press either  or  key to select [OFF] or [ONE] / [TWO].

\* [TWO] can only be selected with CS-3000HDR.

If the "OVER" error message appears when set to [OFF], set **IN-ND** to [ONE] or [TWO].

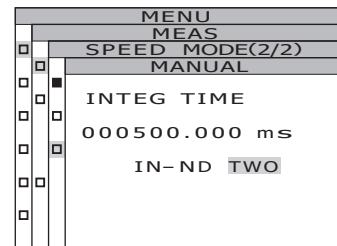

**4-c-7.** Press **ENTER** key.  
When the setting is confirmed, the **MENU - MEAS - SPEED MODE** screen appears again on the LCD.

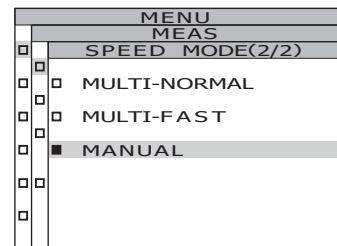

**5.** Press **ESC** key.

When the measurement speed is set, the **MENU - MEAS** screen appears again on the LCD.

**6.** Press **ESC** key.

The **MENU** screen appears again on the LCD.

**7.** Press **ESC** key.

The **MEAS** screen appears again on the LCD.

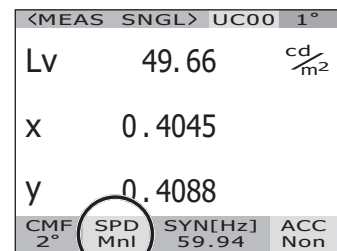

# Setting of Synchronization

The synchronized measurement refers to measurement mode where measurement is made in the same timing as periodic light source blink frequency, such as vertically synchronized frequency for the display device.

## [INT SYNC]

The internal sync measurement mode is used to measure the display equipment without inputting vertically synchronized signals to the main unit, or to measure flickering light from a light source such as a fluorescent light. Input the frequency of vertically synchronized signals for the display equipment, or the commercial frequency (50 or 60 Hz) for flickering light from a light source such as a luminescent light. The optimal integration time is automatically set based on the input value and the brightness of the object. For this reason, enter the correct frequency value to two decimal places.

Note that accurate measurement cannot be performed if a frequency different from the actual one is set. If the frequency cannot be identified, it is recommended to select the **[NO SYNC]** mode without synchronized measurement, and to select the **[MULTI INTEG-NORMAL]** mode or the **[MULTI INTEG-FAST]** mode for the measurement speed (refer to p.26).

\*CS-3000HDR and CS-3000 have a function that detects the display's emission frequency and sets synchronized measurement. (See p.34)

## [EXT SYNC]

The external sync measurement mode is used to measure the display equipment after the line input of a vertically synchronized signal to the main unit via the input terminal for vertically synchronized signals. The optimal integration time is set automatically, based on the frequency of vertically synchronized signals and the brightness of the object. For information on how to input the vertically synchronized signal, see Vertically Synchronized Signal Input Method (p.36).

\* Range of synchronized frequencies : 0.5 to 200.00 Hz

\* Factory default setting : INT SYNC 59.94 Hz

## Operating Procedure

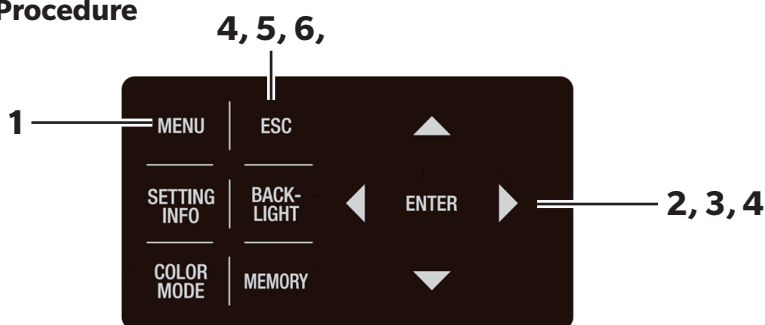

### 1. Press **MENU** key when the MEAS screen is displayed.

The **MENU** screen appears on the LCD.

When the backlight of the LCD has been turned off via **BACKLIGHT** key on the MEAS screen, the backlight is turned on.

◀MEAS SNGL> UC00 1°			
Lv	49.66		cd/m <sup>2</sup>
X	0.4045		
Y	0.4088		
CMF	SPD	SYN[Hz]	ACC
2°	Nrm	59.94	Non

MENU	
<input type="checkbox"/>	MEAS
<input type="checkbox"/>	MEMORY
<input type="checkbox"/>	OPTION
<input type="checkbox"/>	SETUP
<input type="checkbox"/>	DARK MEASUREMENT
<input type="checkbox"/>	INFORMATION

**2. Press either  or  key to select [MEAS] and then press **ENTER** key.**

The **MENU - MEAS** screen appears on the LCD.

The current set contents are displayed in the [SYNC] item.

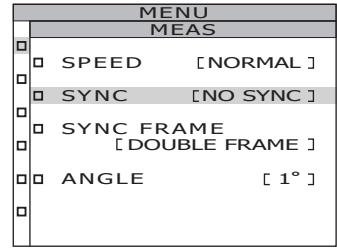

**3. Press either  or  key to select [SYNC] and then press **ENTER** key.**

The **MENU - MEAS - SYNC MODE** (for selection of synchronization method) screen appears on the LCD.

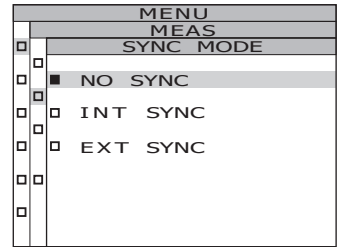

**4. Press either  or  key to select the synchronization method.**

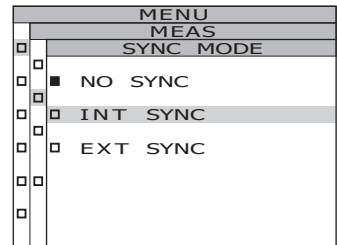

For the INT-SYNC setting

**4-a-1. Select [INT SYNC] and press **ENTER** key.**

The **MENU - MEAS - SYNC MODE - INT SYNC** screen appears on the LCD. This screen is used to input the internal synchronized frequency.

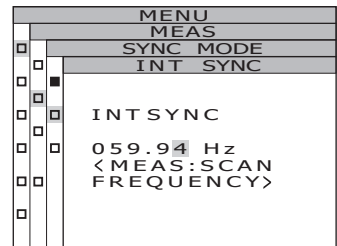

**4-a-2. Press either  or  key to set a value.**

Press  key for a larger number.

Press  key for a smaller number.

The range of the internal synchronized frequency is 20 Hz to 200 Hz.

**4-a-3. Press either  or  key to move the cursor.**

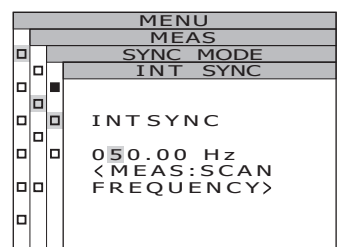

**4-a-4. Repeat the procedures 4-a-2. and -3. for the required number of digits.**

**4-a-5. Press ENTER key.**  
When the setting is confirmed, the **MENU - MEAS - SYNC MODE** screen appears again on the LCD.

**4-a-6. Press ESC key.**  
When the synchronization method is set, the **MENU-MEAS** screen appears again on the LCD.  
The setting of the synchronization method is saved even after the power switch is turned off (O).

.....  
For the NO-SYNC or EXT-SYNC setting

**4-b-1. Select either [NO SYNC] or [EXT SYNC] and press ENTER key.**

**5. Press ESC key.**  
The **MENU** screen appears again on the LCD.

**6. Press ESC key.**  
The **MEAS** screen appears again on the LCD.

<MEAS SNGL> UC00		1°
Lv	49.66	cd/m <sup>2</sup>
X	0.4045	
Y	0.4088	
CMF	SPD	SYN[Hz]
2°	Nrm	50.00
		ACC
		Non



## Emission Frequency Detection and Setting Function (CS-3000HDR/CS-

3000 only)

This function can detect the emission frequency of the display device.

Importing the detected frequency into the synchronized measurement [INT SYNC] prevents lower repeatability caused by synchronization shifts.

\* Detectable range: Luminance of 10 to 5,000 cd/m<sup>2</sup> and emission frequency of 10 to 200 Hz.

### Operating Procedure

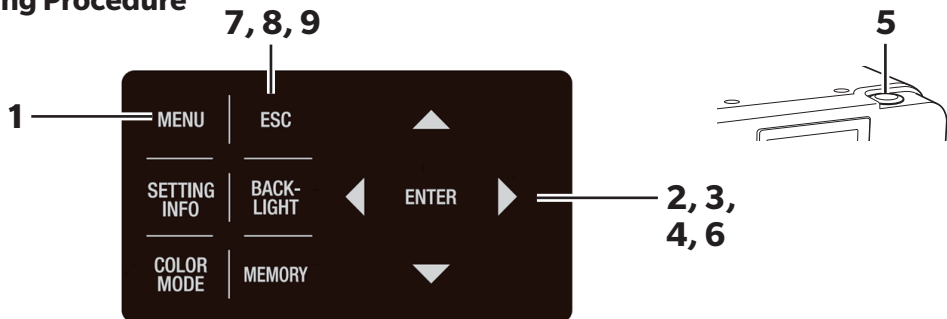

The measurement object and the instrument must be set up in advance and in a condition that allows for proper measurement before performing emission frequency detection.

For details on the setup method, refer to Measurement (p.70).

#### 1. Press **MENU** key when the MEAS screen is displayed.

The **MENU** screen appears on the LCD.

When the backlight of the LCD has been turned off via

**BACKLIGHT** key on the MEAS screen, the

backlight is turned on.

<MEAS SNGL> UC00 1°			
LV	49.35	cd/m <sup>2</sup>	
X	0.3908		
Y	0.4012		
CMF	SPD	SYN[Hz]	ACC
2°	Mnl	59.94	Non

MENU	
<input type="checkbox"/>	MEAS
<input type="checkbox"/>	MEMORY
<input type="checkbox"/>	OPTION
<input type="checkbox"/>	SETUP
<input type="checkbox"/>	DARK MEASUREMENT
<input type="checkbox"/>	INFORMATION

#### 2. Press either **▲** or **▼** key to select [MEAS] and then press **ENTER** key.

The **MENU - MEAS** screen appears on the LCD.

The current set contents are displayed in the **[SYNC]** item.

MENU	
MEAS	
<input type="checkbox"/>	SPEED [MANUAL]
<input type="checkbox"/>	SYNC [INT SYNC]
<input type="checkbox"/>	SYNC FRAME [DOUBLE FRAME]
<input type="checkbox"/>	ANGLE [1°]



**3. Press either  or  key to select [SYNC] and then press  key.**

The **MENU - MEAS - SYNC MODE** screen appears on the LCD.

The **synchronization method selection** screen appears.

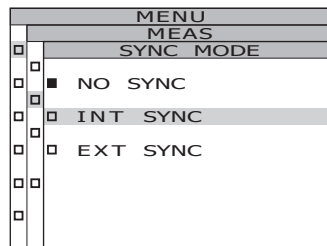

**4. Press either  or  key to select [INT SYNC] and then press  key.**

The **MENU - MEAS - SYNC MODE - INT SYNC** screen appears on the LCD.

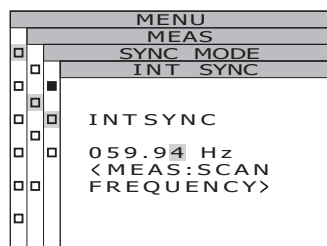

**5. Press the measurement button (MEASURE).**

The emission frequency of the measurement object is detected and the detected frequency is displayed.

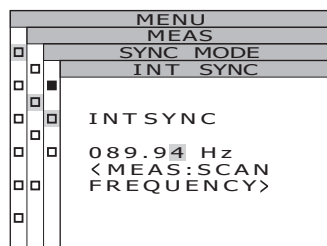

**6. Press  key.**

The detected frequency is imported into the synchronized measurement [INT SYNC].

The **MENU - MEAS - SYNC MODE** screen appears again on the LCD.

**7. Press  key.**

The **MENU - MEAS** screen appears again on the LCD.

**8. Press  key.**

The **MENU** screen appears again on the LCD.

**9. Press  key.**

The **MEAS** screen appears again on the LCD.

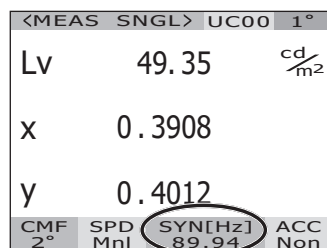

## Vertically Synchronized Signal Input Method

Vertically synchronized signal is input externally and the frequency is detected by the main unit to perform external sync measurement.

The vertically synchronized signal output from the measurement object is input to the main unit via a BNC cable. The input signal must be a CMOS input level (0.8 / 1.2 / 1.8 / 3.3 / 5.0 V, 0.5 to 200 Hz).

Synchronization can be achieved by adjusting the [EXT VOLTAGE] setting on the main unit to the input signal level.

\* Factory default setting: [EXT VOLTAGE] 3.3 V

### Operating Procedure

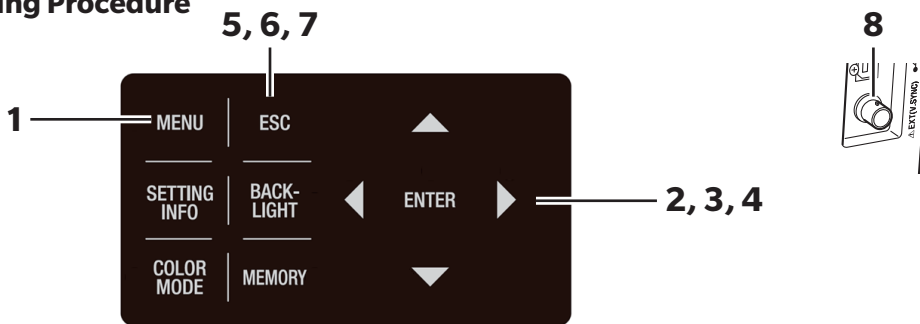

#### 1. Press **MENU** key when the MEAS screen is displayed.

The **MENU** screen appears on the LCD.

When the backlight of the LCD has been turned off via

**BACKLIGHT** key on the MEAS screen, the backlight is turned on.

<MEAS SNGL> UC00		1°
Lv	73.28	cd/m <sup>2</sup>
X	0.3829	
Y	0.3913	
CMF	SPD	SYN[Hz]
2°	Nrm	59.94
		ACC
		Non

MENU	
<input type="checkbox"/>	MEAS
<input type="checkbox"/>	MEMORY
<input type="checkbox"/>	OPTION
<input checked="" type="checkbox"/>	SETUP
<input type="checkbox"/>	DARK MEASUREMENT
<input type="checkbox"/>	INFORMATION

#### 2. Press either **▲** or **▼** key to select **[SETUP]** and then press **ENTER** key.

The **MENU - SETUP** screen appears on the LCD.

MENU	
SETUP(2/3)	
<input type="checkbox"/>	DATA FORM [ F ]
<input type="checkbox"/>	RS-232C BAUDRATE [ 115200bps ]
<input checked="" type="checkbox"/>	EXT VOLTAGE [ 3.3V ]
<input type="checkbox"/>	DATE TIME [ 2022/10/31 11:07:30 ]

- 3. Press either  or  key to select [EXT VOLTAGE] and then press  key.**

The **MENU - SETUP - EXT VOLTAGE** screen appears on the LCD.

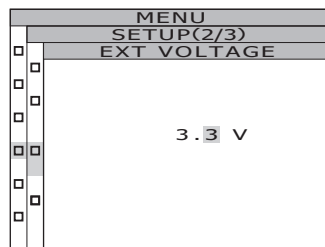

- 4. Input the voltage value of the input signal in [EXT VOLTAGE].**

**Press either  or  key to move the cursor.**

**Press either  or  key to set voltage and then press  key.**

The **MENU - SETUP - EXT VOLTAGE** screen appears on the LCD.

The current set contents are displayed in the **[EXT VOLTAGE]** item.

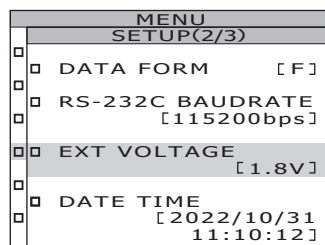
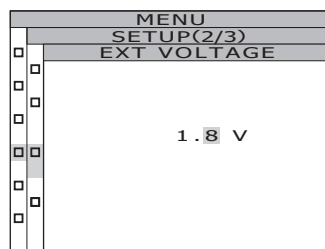

- 5. Press  key.**

The **MENU - SETUP** screen appears again on the LCD.

- 6. Press  key.**

The **MENU** screen appears again on the LCD.

- 7. Press  key.**

The **MEAS** screen appears again on the LCD.

- 8. The measurement object's vertically synchronized signal output terminal and the main unit's vertically synchronized signal input terminal are connected by a BNC cable.**

# Selecting Synchronous Frames

In synchronized measurement, synchronous frames can be selected from “SINGLE FRAME” or “DOUBLE FRAME.”

In the case of “SINGLE FRAME,” synchronized measurement is performed with the vertical scan signal period as one cycle.

In the case of “DOUBLE FRAME,” synchronized measurement is performed with one cycle being twice the vertical scan signal cycle.

When flickering occurs on the LCD, the screen is fluctuating at half the vertical scanning frequency. For stable measurement of LCDs, it is recommended to set the integration time to twice the vertical scan period (“DOUBLE FRAME”).

\* Factory default setting: DOUBLE FRAME

## Operating Procedure

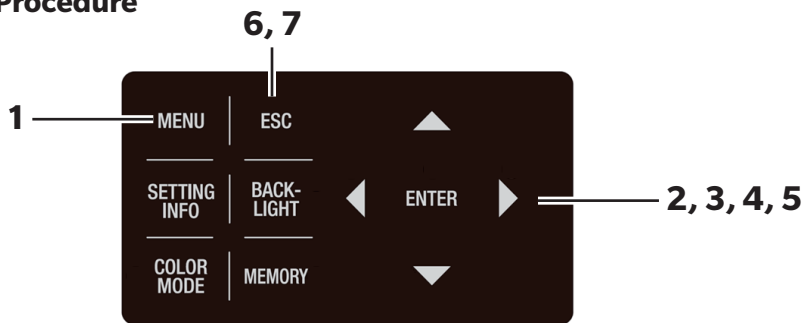

1. Press **MENU** key when the MEAS screen is displayed.

The **MENU** screen appears on the LCD.

When the backlight of the LCD has been turned off via

**BACKLIGHT** key on the MEAS screen, the backlight is turned on.

〈MEAS SNGL〉 UC00 1°			
LV			cd/m <sup>2</sup>
X			
y			
CMF 2°	SPD Nrm	SYN[Hz] 59.94	ACC Non

MENU	
<input type="checkbox"/>	MEAS
<input type="checkbox"/>	MEMORY
<input type="checkbox"/>	OPTION
<input type="checkbox"/>	SETUP
<input type="checkbox"/>	DARK MEASUREMENT
<input type="checkbox"/>	INFORMATION

2. Press either **▲** or **▼** key to select [MEAS] and then press **ENTER** key.

The **MENU - MEAS** screen appears on the LCD.

The current set contents are displayed in the **[SYNC FRAME]** item.

MENU	
MEAS	
<input type="checkbox"/>	SPEED [NORMAL]
<input type="checkbox"/>	SYNC [INT SYNC]
<input type="checkbox"/>	SYNC FRAME [DOUBLE FRAME]
<input type="checkbox"/>	ANGLE [1°]

**3. Press either  or  key to select [SYNC FRAME] and then press  key.**

The **MENU - MEAS - SYNC FRAME** screen appears on the LCD.

The **synchronous frame selection screen** appears.

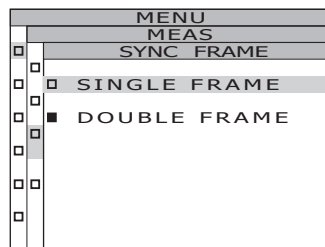

**4. Press either  or  key to select [SINGLE FRAME] / [DOUBLE FRAME].**

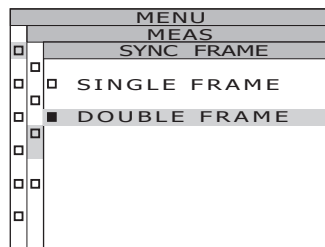

**5. Press  key.**

When the synchronous frame is set, the **MENU - MEAS screen** appears again on the LCD.

By pressing the  key, the setting is canceled and the **MENU - MEAS screen** appears again on the LCD.

The display format setting is saved even after the power switch is turned OFF (O).

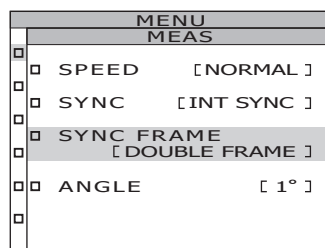

**6. Press  key.**

The **MENU screen** appears again on the LCD.

**7. Press  key.**

The **MEAS screen** appears again on the LCD.

# Selecting Measurement Angle

The measurement angle can be selected from 1°, 0.2°, or 0.1°.

For the CS-3000HDR/CS-3000, the measurement angle is switched electrically according to the selection made on the MENU screen. Motor noise may be heard when switching the measurement angle, but this is not abnormal.

For the CS-2000Plus, the measurement angle is switched by manually rotating the measurement angle selector.

For details on measurement distance and diameters, refer to the below table. Attach the closeup lens (optional accessory) if necessary.

\* Factory default setting: 1°

(Unit: mm)

(Measurement angle)	Minimum measurement diameter $\phi$			Maximum measurement diameter $\phi$			Minimum objective distance			Maximum objective distance			Measurement diameter $\phi$ for 500 mm measurement distance			Measurement diameter $\phi$ for 1,000 mm measurement distance			
	1°	0.2°	0.1°	1°	0.2°	0.1°	1°	0.2°	0.1°	1°	0.2°	0.1°	1°	0.2°	0.1°	1°	0.2°	0.1°	
Without closeup lens	5.00	1.00	0.50	$\infty$	$\infty$	$\infty$	350			$\infty$			7.78	1.56	0.78	16.66	3.33	1.67	
With closeup lens	1.00	0.20	0.10	1.39	0.28	0.14	55.0			70.9			-	-	-	-	-	-	-

\* The measurement distance is the distance from the tip of the objective lens or the metallic part of the closeup lens.

## Operating Procedure

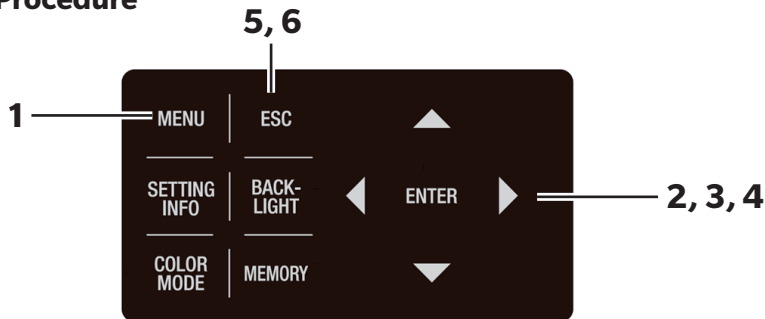

### 1. Press **MENU** key when the MEAS screen is displayed.

The **MENU** screen appears on the LCD.

When the backlight of the LCD has been turned off via **BACKLIGHT** key on the MEAS screen, the backlight is turned on.

<MEAS SNGL> UC00 1°			
Lv			cd/m <sup>2</sup>
X			
y			
CMF 2°	SPD Nrm	SYN[Hz] 59.94	ACC Non

MENU
<input type="checkbox"/> MEAS
<input type="checkbox"/> MEMORY
<input type="checkbox"/> OPTION
<input type="checkbox"/> SETUP
<input type="checkbox"/> DARK MEASUREMENT
<input type="checkbox"/> INFORMATION

**2. Press either  $\blacktriangle$  or  $\blacktriangledown$  key to select [MEAS] and then press  $\boxed{\text{ENTER}}$  key.**

The **MENU - MEAS** screen appears on the LCD.

The current set contents are displayed in the **[ANGLE]** item.

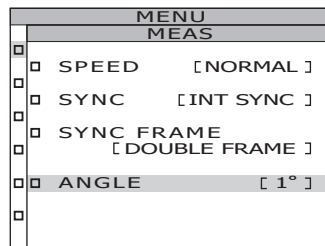

**3. Press either  $\blacktriangle$  or  $\blacktriangledown$  key to select [ANGLE] and then press  $\boxed{\text{ENTER}}$  key.**

The **MENU - ANGLE (for selection of measurement angle)** screen appears on the LCD.

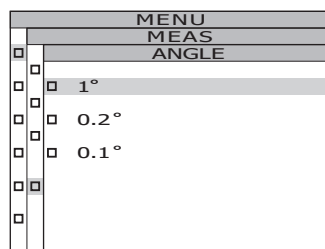

**4. Press either  $\blacktriangle$  or  $\blacktriangledown$  key to select [1°] / [0.2°] / [0.1°] and then press  $\boxed{\text{ENTER}}$  key.**

When the measurement angle is set, the MENU - MEAS screen appears again on the LCD.

Motor noise may be heard when switching the measurement angle electrically, but this is not abnormal.

By pressing the  $\boxed{\text{ESC}}$  key, the setting is canceled and the **MENU - MEAS** screen appears again on the LCD.

The display format setting is saved even after the power switch is turned OFF (O).

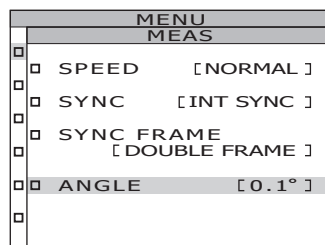

**5. Press  $\boxed{\text{ESC}}$  key.**

The **MENU** screen appears again on the LCD.

**6. Press  $\boxed{\text{ESC}}$  key.**

The **MEAS** screen appears again on the LCD.

**CS-2000Plus**

**The measurement angle is set to any of [1°], [0.2°] or [0.1°] by rotating the measurement angle selector.**

Do not move the measurement angle selector during measurement. Switching during measurement may result in failure of measurement or erroneous readings.

When rotating the measurement angle selector, move it to the position where you feel a click. Rotating it only halfway may result in failure of measurement or erroneous readings.

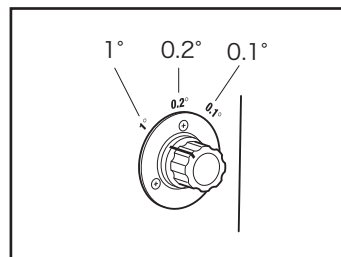

# Selecting Color Matching Functions

Select the color matching function (CMF) to be used in the chromaticity calculation.

\* Setting color matching function : CIE1931 (2°), CIE1964 (10°), CIE170-2:2015 (PA2°), CIE170-2:2015 (PA10°)

\* Factory default setting : CIE1931 (2°)

## Operating Procedure

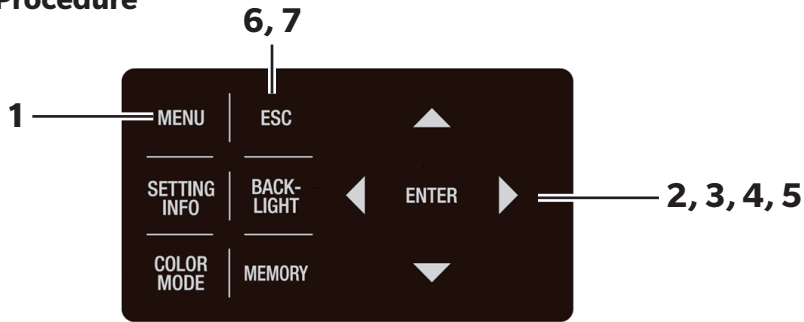

1. Press **MENU** key when the MEAS screen is displayed.

The **MENU** screen appears on the LCD.

When the backlight of the LCD has been turned off via **BACKLIGHT** key on the MEAS screen, the backlight is turned on.

<MEAS SNGL> UC00		1°
Lv	49.66	cd/m <sup>2</sup>
X	0.4045	
Y	0.4088	
CMF	SPD	SYN[Hz]
2°	Nrm	59.94
		ACC
		Non

MENU	
<input type="checkbox"/>	MEAS
<input type="checkbox"/>	MEMORY
<input type="checkbox"/>	OPTION
<input checked="" type="checkbox"/>	SETUP
<input type="checkbox"/>	DARK MEASUREMENT
<input type="checkbox"/>	INFORMATION

2. Press either **▲** or **▼** key to select **[SETUP]** and then press **ENTER** key.

The **MENU - SETUP** screen appears on the LCD.

The current set contents are displayed in the **[CMF]** item.

MENU	
SETUP(1/3)	
<input checked="" type="checkbox"/>	CMF [ 2° ]
<input type="checkbox"/>	BACKLIGHT@MEAS [ON]
<input checked="" type="checkbox"/>	RS-POWER SUPPLY [OFF]
<input type="checkbox"/>	
<input type="checkbox"/>	

3. Press either **▲** or **▼** key to select **[CMF]** and then press **ENTER** key.

The **MENU - SETUP - CMF (for selection of color matching function)** screen appears on the LCD.

MENU	
SETUP(1/3)	
CMF	
<input checked="" type="checkbox"/>	CIE 1931(2°)
<input type="checkbox"/>	CIE 1964(10°)
<input type="checkbox"/>	CIE 170-2(2°)
<input type="checkbox"/>	CIE 170-2(10°)
<input type="checkbox"/>	



4. Press either  or  key to select [2°] / [10°] / [PA2°] / [PA10°].

MENU	
SETUP(1/3)	
CMF	
<input type="checkbox"/>	CIE 1931(2°)
<input checked="" type="checkbox"/>	CIE 1964(10°)
<input type="checkbox"/>	CIE 170-2(2°)
<input type="checkbox"/>	CIE 170-2(10°)

5. Press **ENTER** key.

When the color matching function is set, the **MENU - Setup screen** appears again on the LCD.

By pressing the **ESC** key, the setting is canceled and the **MENU - SETUP screen** appears again on the LCD.

The observer setting is saved even after the power switch is turned off (O).

6. Press **ESC** key.

The **MENU screen** appears again on the LCD.

7. Press **ESC** key.

The **MEAS screen** appears again on the LCD.

If the color matching function is set to a value other than CIE1931 (2°), the  $L_v$  display switches to Y display.

<MEAS SNGL> UC00 1°			
Y		52.05	
X		0.4140	
Y		0.4002	
CMF	SPD	SYN[Hz]	ACC
10°	Nrm	59.94	Non



# Selecting Display Format

The formats for indicating the luminance and excitation values X, Y and Z can be selected as either normal indication to display the values to four places of decimals, or as index number indication. If the measurement values on the LCD are unreadable, use the index number indication.

\* Display format setting: Normal, Index

\* Factory default setting: \*\*\*\*\* [F]

\* When the number of displayed digits is six (luminance and X/Y/Z are 1000000 or more) in the normal indication, "\*\*\*\*\*" will be displayed. In this case, the value will be displayed if you set it to the index number indication.

## Operating Procedure

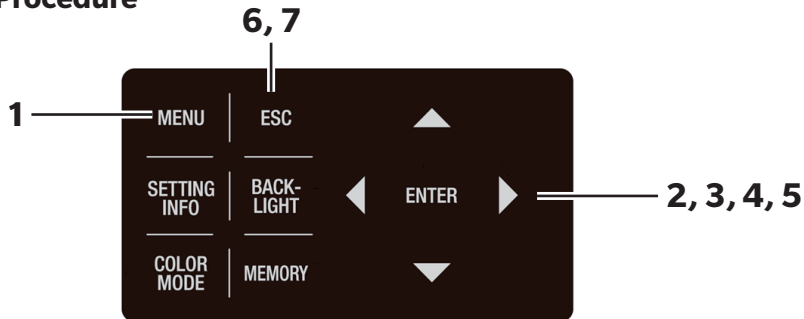

### 1. Press **MENU** key when the MEAS screen is displayed.

The **MENU** screen appears on the LCD.

When the backlight of the LCD has been turned off via

**BACKLIGHT** key on the MEAS screen, the backlight is turned on.

<MEAS SNGL>		UC00	1°
Lv	49.66		cd/m <sup>2</sup>
X	0.4045		
Y	0.4088		
CMF	SPD	SYN[Hz]	ACC
2°	Nrm	59.94	Non

MENU	
<input type="checkbox"/>	MEAS
<input type="checkbox"/>	MEMORY
<input type="checkbox"/>	OPTION
<input checked="" type="checkbox"/>	SETUP
<input type="checkbox"/>	DARK MEASUREMENT
<input type="checkbox"/>	INFORMATION

### 2. Press either **▲** or **▼** key to select **[SETUP]** and then press **ENTER** key.

The **MENU - SETUP** screen appears on the LCD.

The current set contents are displayed in the **[DATA FORM]** item.

MENU	
SETUP(2/3)	
<input checked="" type="checkbox"/>	DATA FORM [F]
<input type="checkbox"/>	RS-232C BAUDRATE [115200bps]
<input type="checkbox"/>	EXT VOLTAGE [3.3V]
<input type="checkbox"/>	DATE TIME [2022/10/07 11:38:04]

**3. Press either  $\blacktriangle$  or  $\blacktriangledown$  key to select [DATA FORM] and then press **ENTER** key.**

The **MENU - SETUP - DATA FORM (for selection of data format)** screen appears on the LCD.

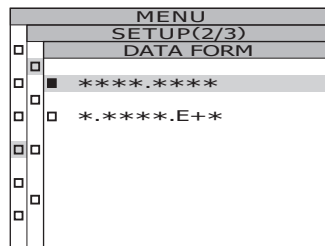

**4. Press either  $\blacktriangle$  or  $\blacktriangledown$  key to select [\*\*\*\*.\*\*\*\* [F]] or [\*..\*\*\*\*E+\* [E]].**

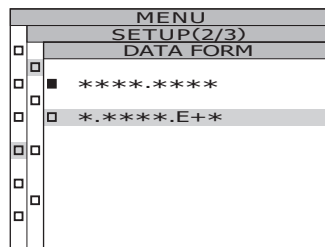

**5. Press **ENTER** key.**

When the display format is set, the **MENU - SETUP** screen appears again on the LCD.

By pressing the **ESC** key, the setting is canceled and the **MENU - SETUP** screen appears again on the LCD.

The display format setting is saved even after the power switch is turned OFF (O).

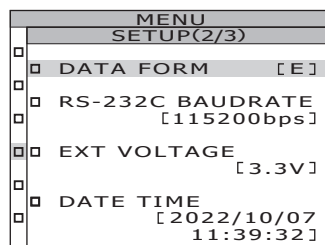

**6. Press **ESC** key.**

The **MENU** screen appears again on the LCD.

**7. Press **ESC** key.**

The **MEAS** screen appears again on the LCD.

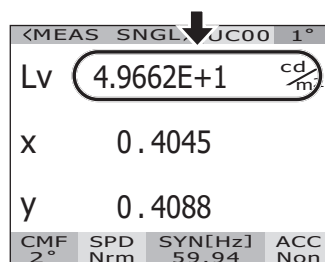

## Process Settings for Negative Spectral Radiance Values

Depending on the measurement, the spectral radiance may be a negative value. You can select from the following two types of processing when a negative value is generated.

- NO PROC: Process as negative value
- TO ZERO: Process negative value as 0

\* Factory default setting: \*[NEGATIVE VALUE] NO PROC

### Operating Procedure

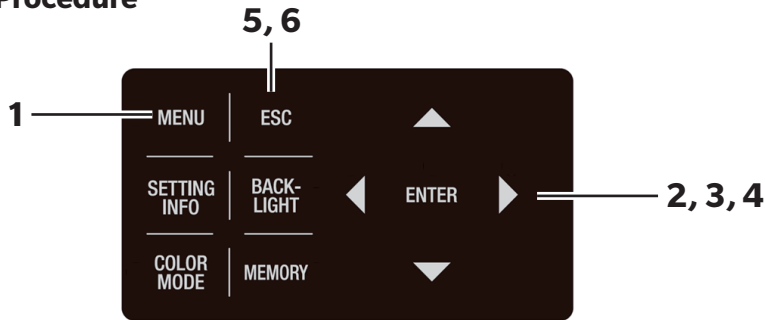

1. Press **MENU** key when the MEAS screen is displayed.

The **MENU** screen appears on the LCD.

When the backlight of the LCD has been turned off via

**BACKLIGHT** key on the MEAS screen, the backlight is turned on.

◀MEAS SNGL> UC00 1°			
Lv	68.12	cd/m <sup>2</sup>	
X	0.3814		
Y	0.3909		
CMF	SPD	SYN[Hz]	ACC
2°	Nrm	59.94	Non



MENU	
<input type="checkbox"/>	MEAS
<input type="checkbox"/>	MEMORY
<input checked="" type="checkbox"/>	OPTION
<input type="checkbox"/>	SETUP
<input type="checkbox"/>	DARK MEASUREMENT
<input type="checkbox"/>	INFORMATION

2. Press either **▲** or **▼** key to select **[OPTION]** and then press **ENTER** key.

The **MENU - OPTION** screen appears on the LCD.



The current set contents are displayed in the **[NEGATIVE VALUE]** item.

MENU	
OPTION(1/2)	
<input checked="" type="checkbox"/>	NEGATIVE VALUE [TO ZERO]
<input checked="" type="checkbox"/>	USER CAL [OFF]
<input checked="" type="checkbox"/>	CLOSE UP [OFF]
<input checked="" type="checkbox"/>	EXT-ND [OFF]
<input type="checkbox"/>	

3. Press either  or  key to select [NEGATIVE VALUE] and then press **ENTER** key.

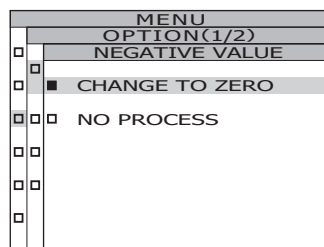
The **MENU - OPTION - NEGATIVE VALUE** screen appears on the LCD.



4. Press either  or  key to select [NO PROC] / [TO ZERO] and then press **ENTER** key.

The **MENU - OPTION** screen appears again on the LCD.

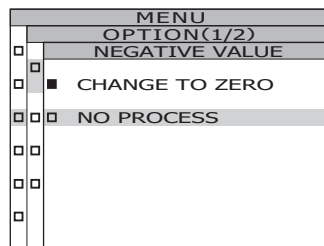

5. Press **ESC** key.

The **MENU** screen appears again on the LCD.

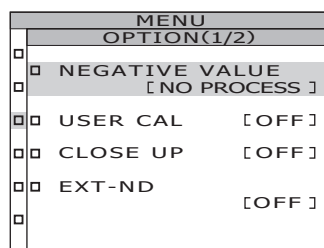

6. Press **ESC** key.

The **MEAS** screen appears again on the LCD.

# Selecting Color Space

See the below table for available color space.

\* Factory default setting :  $L_vxy^*1$

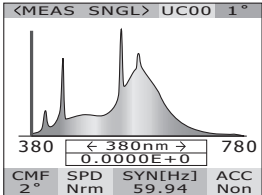
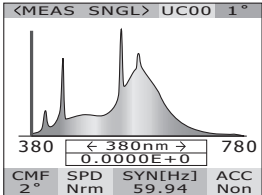
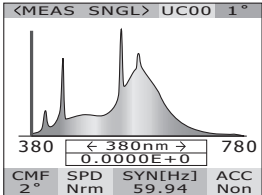
Color space	LCD screen		Display description																																																
	(When Normal is selected for display format)	(When Index is selected for display format)																																																	
$L_vxy^*1$	<table border="1"> <tr><td colspan="4">◀MEAS SNGL▶ UC00 1°</td></tr> <tr><td>Lv</td><td>49.66</td><td><math>\frac{cd}{m^2}</math></td><td></td></tr> <tr><td>x</td><td>0.4045</td><td></td><td></td></tr> <tr><td>y</td><td>0.4088</td><td></td><td></td></tr> <tr><td>CMF</td><td>SPD</td><td>SYN[Hz]</td><td>ACC</td></tr> <tr><td>2°</td><td>Nrm</td><td>59.94</td><td>Non</td></tr> </table>	◀MEAS SNGL▶ UC00 1°				Lv	49.66	$\frac{cd}{m^2}$		x	0.4045			y	0.4088			CMF	SPD	SYN[Hz]	ACC	2°	Nrm	59.94	Non	<table border="1"> <tr><td colspan="4">◀MEAS SNGL▶ UC00 1°</td></tr> <tr><td>Lv</td><td>4.9662E+1</td><td><math>\frac{cd}{m^2}</math></td><td></td></tr> <tr><td>x</td><td>0.4045</td><td></td><td></td></tr> <tr><td>y</td><td>0.4088</td><td></td><td></td></tr> <tr><td>CMF</td><td>SPD</td><td>SYN[Hz]</td><td>ACC</td></tr> <tr><td>2°</td><td>Nrm</td><td>59.94</td><td>Non</td></tr> </table>	◀MEAS SNGL▶ UC00 1°				Lv	4.9662E+1	$\frac{cd}{m^2}$		x	0.4045			y	0.4088			CMF	SPD	SYN[Hz]	ACC	2°	Nrm	59.94	Non	Displays and outputs in luminance $L_v$ and chromaticity coordinates x, y.
◀MEAS SNGL▶ UC00 1°																																																			
Lv	49.66	$\frac{cd}{m^2}$																																																	
x	0.4045																																																		
y	0.4088																																																		
CMF	SPD	SYN[Hz]	ACC																																																
2°	Nrm	59.94	Non																																																
◀MEAS SNGL▶ UC00 1°																																																			
Lv	4.9662E+1	$\frac{cd}{m^2}$																																																	
x	0.4045																																																		
y	0.4088																																																		
CMF	SPD	SYN[Hz]	ACC																																																
2°	Nrm	59.94	Non																																																
$L_vu'v'^*1$	<table border="1"> <tr><td colspan="4">◀MEAS SNGL▶ UC00 1°</td></tr> <tr><td>Lv</td><td>49.66</td><td><math>\frac{cd}{m^2}</math></td><td></td></tr> <tr><td>u'</td><td>0.2280</td><td></td><td></td></tr> <tr><td>v'</td><td>0.5185</td><td></td><td></td></tr> <tr><td>CMF</td><td>SPD</td><td>SYN[Hz]</td><td>ACC</td></tr> <tr><td>2°</td><td>Nrm</td><td>59.94</td><td>Non</td></tr> </table>	◀MEAS SNGL▶ UC00 1°				Lv	49.66	$\frac{cd}{m^2}$		u'	0.2280			v'	0.5185			CMF	SPD	SYN[Hz]	ACC	2°	Nrm	59.94	Non	<table border="1"> <tr><td colspan="4">◀MEAS SNGL▶ UC00 1°</td></tr> <tr><td>Lv</td><td>4.9662E+1</td><td><math>\frac{cd}{m^2}</math></td><td></td></tr> <tr><td>u'</td><td>0.2280</td><td></td><td></td></tr> <tr><td>v'</td><td>0.5185</td><td></td><td></td></tr> <tr><td>CMF</td><td>SPD</td><td>SYN[Hz]</td><td>ACC</td></tr> <tr><td>2°</td><td>Nrm</td><td>59.94</td><td>Non</td></tr> </table>	◀MEAS SNGL▶ UC00 1°				Lv	4.9662E+1	$\frac{cd}{m^2}$		u'	0.2280			v'	0.5185			CMF	SPD	SYN[Hz]	ACC	2°	Nrm	59.94	Non	Displays and outputs in luminance $L_v$ and $u'v'$ chromaticity diagram (CIE 1976 UCS chromaticity diagram) coordinates $u', v'$ .
◀MEAS SNGL▶ UC00 1°																																																			
Lv	49.66	$\frac{cd}{m^2}$																																																	
u'	0.2280																																																		
v'	0.5185																																																		
CMF	SPD	SYN[Hz]	ACC																																																
2°	Nrm	59.94	Non																																																
◀MEAS SNGL▶ UC00 1°																																																			
Lv	4.9662E+1	$\frac{cd}{m^2}$																																																	
u'	0.2280																																																		
v'	0.5185																																																		
CMF	SPD	SYN[Hz]	ACC																																																
2°	Nrm	59.94	Non																																																
$L_vT_{cp}\Delta uv$	<table border="1"> <tr><td colspan="4">◀MEAS SNGL▶ UC00 1°</td></tr> <tr><td>Lv</td><td>49.66</td><td><math>\frac{cd}{m^2}</math></td><td></td></tr> <tr><td>Tcp</td><td>3657K</td><td></td><td></td></tr> <tr><td>duv</td><td>+0.008</td><td></td><td></td></tr> <tr><td>CMF</td><td>SPD</td><td>SYN[Hz]</td><td>ACC</td></tr> <tr><td>2°</td><td>Nrm</td><td>59.94</td><td>Non</td></tr> </table>	◀MEAS SNGL▶ UC00 1°				Lv	49.66	$\frac{cd}{m^2}$		Tcp	3657K			duv	+0.008			CMF	SPD	SYN[Hz]	ACC	2°	Nrm	59.94	Non	<table border="1"> <tr><td colspan="4">◀MEAS SNGL▶ UC00 1°</td></tr> <tr><td>Lv</td><td>4.9662E+1</td><td><math>\frac{cd}{m^2}</math></td><td></td></tr> <tr><td>Tcp</td><td>3657K</td><td></td><td></td></tr> <tr><td>duv</td><td>+0.008</td><td></td><td></td></tr> <tr><td>CMF</td><td>SPD</td><td>SYN[Hz]</td><td>ACC</td></tr> <tr><td>2°</td><td>Nrm</td><td>59.94</td><td>Non</td></tr> </table>	◀MEAS SNGL▶ UC00 1°				Lv	4.9662E+1	$\frac{cd}{m^2}$		Tcp	3657K			duv	+0.008			CMF	SPD	SYN[Hz]	ACC	2°	Nrm	59.94	Non	Displays and outputs in luminance $L_v$ , correlated color temperature $T_{cp}$ and color difference from black body locus $\Delta uv$ .
◀MEAS SNGL▶ UC00 1°																																																			
Lv	49.66	$\frac{cd}{m^2}$																																																	
Tcp	3657K																																																		
duv	+0.008																																																		
CMF	SPD	SYN[Hz]	ACC																																																
2°	Nrm	59.94	Non																																																
◀MEAS SNGL▶ UC00 1°																																																			
Lv	4.9662E+1	$\frac{cd}{m^2}$																																																	
Tcp	3657K																																																		
duv	+0.008																																																		
CMF	SPD	SYN[Hz]	ACC																																																
2°	Nrm	59.94	Non																																																
XYZ	<table border="1"> <tr><td colspan="4">◀MEAS SNGL▶ UC00 1°</td></tr> <tr><td>X</td><td>49.14</td><td><math>\frac{cd}{m^2}</math></td><td></td></tr> <tr><td>Y</td><td>49.66</td><td></td><td></td></tr> <tr><td>Z</td><td>22.67</td><td></td><td></td></tr> <tr><td>CMF</td><td>SPD</td><td>SYN[Hz]</td><td>ACC</td></tr> <tr><td>2°</td><td>Nrm</td><td>59.94</td><td>Non</td></tr> </table>	◀MEAS SNGL▶ UC00 1°				X	49.14	$\frac{cd}{m^2}$		Y	49.66			Z	22.67			CMF	SPD	SYN[Hz]	ACC	2°	Nrm	59.94	Non	<table border="1"> <tr><td colspan="4">◀MEAS SNGL▶ UC00 1°</td></tr> <tr><td>X</td><td>4.9137E+1</td><td><math>\frac{cd}{m^2}</math></td><td></td></tr> <tr><td>Y</td><td>4.9662E+1</td><td></td><td></td></tr> <tr><td>Z</td><td>2.2672E+1</td><td></td><td></td></tr> <tr><td>CMF</td><td>SPD</td><td>SYN[Hz]</td><td>ACC</td></tr> <tr><td>2°</td><td>Nrm</td><td>59.94</td><td>Non</td></tr> </table>	◀MEAS SNGL▶ UC00 1°				X	4.9137E+1	$\frac{cd}{m^2}$		Y	4.9662E+1			Z	2.2672E+1			CMF	SPD	SYN[Hz]	ACC	2°	Nrm	59.94	Non	Displays and outputs in tristimulus values X, Y, Z.
◀MEAS SNGL▶ UC00 1°																																																			
X	49.14	$\frac{cd}{m^2}$																																																	
Y	49.66																																																		
Z	22.67																																																		
CMF	SPD	SYN[Hz]	ACC																																																
2°	Nrm	59.94	Non																																																
◀MEAS SNGL▶ UC00 1°																																																			
X	4.9137E+1	$\frac{cd}{m^2}$																																																	
Y	4.9662E+1																																																		
Z	2.2672E+1																																																		
CMF	SPD	SYN[Hz]	ACC																																																
2°	Nrm	59.94	Non																																																
Dominant wavelength / Excitation purity*2	<table border="1"> <tr><td colspan="4">◀MEAS SNGL▶ UC00 1°</td></tr> <tr><td><math>\lambda_d</math></td><td>+577.328nm</td><td></td><td></td></tr> <tr><td><math>P_e</math></td><td>44.14%</td><td></td><td></td></tr> <tr><td>CMF</td><td>SPD</td><td>SYN[Hz]</td><td>ACC</td></tr> <tr><td>2°</td><td>Nrm</td><td>59.94</td><td>Non</td></tr> </table>		◀MEAS SNGL▶ UC00 1°				$\lambda_d$	+577.328nm			$P_e$	44.14%			CMF	SPD	SYN[Hz]	ACC	2°	Nrm	59.94	Non	Displays and outputs in dominant wavelength $\lambda_d$ and excitation purity $P_e$ .																												
◀MEAS SNGL▶ UC00 1°																																																			
$\lambda_d$	+577.328nm																																																		
$P_e$	44.14%																																																		
CMF	SPD	SYN[Hz]	ACC																																																
2°	Nrm	59.94	Non																																																
Spectral graph	<table border="1"> <tr><td colspan="4">◀MEAS SNGL▶ UC00 1°</td></tr> <tr><td colspan="4"></td></tr> <tr><td>CMF</td><td>SPD</td><td>SYN[Hz]</td><td>ACC</td></tr> <tr><td>2°</td><td>Nrm</td><td>59.94</td><td>Non</td></tr> </table>		◀MEAS SNGL▶ UC00 1°								CMF	SPD	SYN[Hz]	ACC	2°	Nrm	59.94	Non	Displays or outputs spectral radiance $L_e(\lambda)$ in the spectral waveform																																
◀MEAS SNGL▶ UC00 1°																																																			
																																																			
CMF	SPD	SYN[Hz]	ACC																																																
2°	Nrm	59.94	Non																																																

- \*1 Y is displayed instead of  $L_v$  when color matching function is other than CIE1931 (2°).
- \*2 For non-spectral colors, the complementary wavelength will be displayed. The display indication will remain  $\lambda d$ .
- \* If the calculated value does not establish a proper combination with the value in the color space mode, “\_\_\_\_\_” will be displayed.

## Operating Procedure

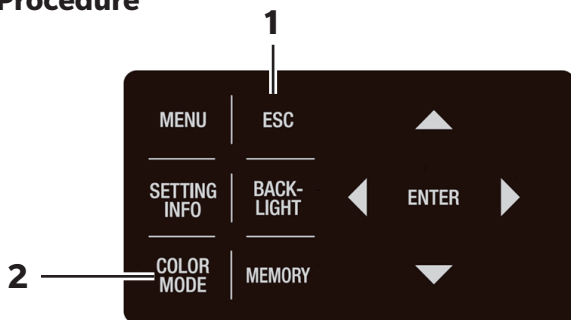

**1. When the MENU or MEMORY screen is displayed, press ESC key to switch to the MEAS screen.**

<MEAS SNGL> UC00		1°
Lv	49.66	cd/m <sup>2</sup>
x	0.4045	
y	0.4088	
CMF	SPD	SYN[Hz]
2°	Nrm	59.94
		ACC
		Non

**2. Press COLOR MODE key to display the desired color space.**

While pressing COLOR MODE key, measurement screen switches in order of  $L_vxy \rightarrow L_vu'v' \rightarrow L_vT_{cp}\Delta uv \rightarrow XYZ \rightarrow \lambda d/Pe \rightarrow$  Spectral graph  $\rightarrow L_vxy \rightarrow$  and so on. When the color matching function is other than CIE1931 (2°), it switches in order of  $Yxy \rightarrow Yu'v' \rightarrow XYZ \rightarrow \lambda d/Pe \rightarrow$  Spectral graph  $\rightarrow Yxy \rightarrow$  and so on.

The color space setting is saved even after the power switch is turned off (O).

<MEAS SNGL> UC00		1°
Lv	49.66	cd/m <sup>2</sup>
u'	0.2280	
v'	0.5185	
CMF	SPD	SYN[Hz]
2°	Nrm	59.94
		ACC
		Non

# Using the Closeup Lens

Use the closeup lens in the optional accessories to measure microscopic surfaces. For instructions on how to attach the closeup lens, refer to the instruction manual for the closeup lens.

If the closeup lens is attached, the measurement value must be compensated for the lens transmittance. This compensation coefficient is included with the closeup lens. After setting up the instrument using the CS-S30 software for spectroradiometers that is a standard accessory included with the instrument, a closeup lens can be selected as an accessory to obtain measurement values corrected by the correction coefficient. For details on how to set up using the software, see the CS-S30 instruction manual.

Setting the wrong lens type will lead to inaccurate measurement.

Moreover, do not use the closeup lens with the ND filter and illuminance adapter. as this will lead to inaccurate measurement.

## Operating Procedure

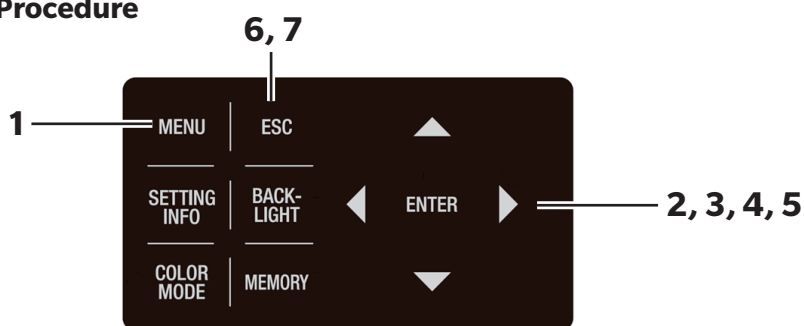

### 1. Press **MENU** key when the MEAS screen is displayed.

The **MENU** screen appears on the LCD.

When the backlight of the LCD has been turned off via **BACKLIGHT** key on the MEAS screen, the backlight is turned on.

<MEAS SNGL> UC00		1°
Lv	67.82	cd/m <sup>2</sup>
X	0.4041	
Y	0.4070	
CMF	SPD	SYN[Hz]
2°	Nrm	59.94
		ACC
		Non

MENU	
<input type="checkbox"/>	MEAS
<input type="checkbox"/>	MEMORY
<input checked="" type="checkbox"/>	OPTION
<input type="checkbox"/>	SETUP
<input type="checkbox"/>	DARK MEASUREMENT
<input type="checkbox"/>	INFORMATION

### 2. Press either **▲** or **▼** key to select **[OPTION]** and then press **ENTER** key.

The **MENU - OPTION** screen appears on the LCD.

MENU	
OPTION(1/2)	
<input type="checkbox"/>	NEGATIVE VALUE [NO PROC]
<input type="checkbox"/>	
<input checked="" type="checkbox"/>	USER CAL [OFF]
<input checked="" type="checkbox"/>	CLOSE UP [OFF]
<input checked="" type="checkbox"/>	EXT-ND [OFF]
<input type="checkbox"/>	



**3. Press either  $\blacktriangle$  or  $\blacktriangledown$  key to select [CLOSE UP] and then press **ENTER** key.**

The **MENU - OPTION - CLOSE UP** (for selection of [OFF] / [ON]) screen appears on the LCD.

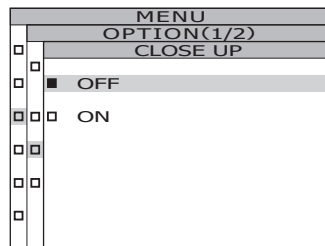

**4. Press either  $\blacktriangle$  or  $\blacktriangledown$  key to select [ON].**

When the closeup lens is removed, select [OFF].

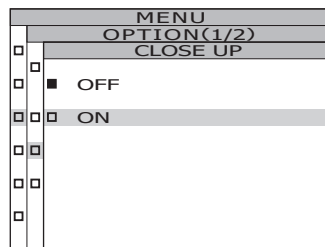

**5. Press **ENTER** key.**

When the closeup lens is set, the **MENU - OPTION screen** appears again on the LCD.

By pressing the **ESC** key, the setting is canceled and the **MENU - OPTION screen** appears again on the LCD.

The lens type setting is saved even after the power switch is turned off (O).

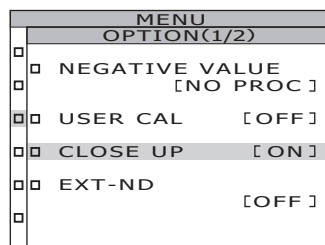

**6. Press **ESC** key.**

The **MENU screen** appears again on the LCD.

**7. Press **ESC** key.**

The **MEAS screen** appears again on the LCD.

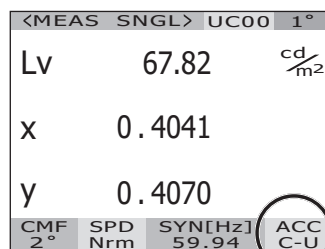

# Using the ND Filter

Use the ND filter in the optional accessories to measure high-luminance objects.

If the ND filter is attached, the measurement value must be compensated for the filter transmittance. This compensation coefficient is attached to the ND filter. After setting up the instrument using the CS-S30 software for spectroradiometers that comes standard with the instrument, an ND filter can be selected as an accessory to obtain measurement values corrected by the correction coefficient. For details on how to set up using the software, see the CS-S30 instruction manual.

Setting the wrong ND filter will lead to inaccurate measurement.

Moreover, do not use the ND filter with the closeup lens and illuminance adapter. as this will lead to inaccurate measurement.

Note that an extra ND filter is built into this instrument. There are three setting options for use or non-use of this built-in ND filter: [AUTO] for switching automatically depending on the luminance of the object, [OFF] for constant non-use, and [ONE] / [TWO] for constant use (See p.28).

\* EXT-ND : OFF, EXT-ND10 (1/10), EXT-ND100 (1/100)

\* Factory default setting : EXT-ND: OFF, IN-ND: AUTO

## Operating Procedure

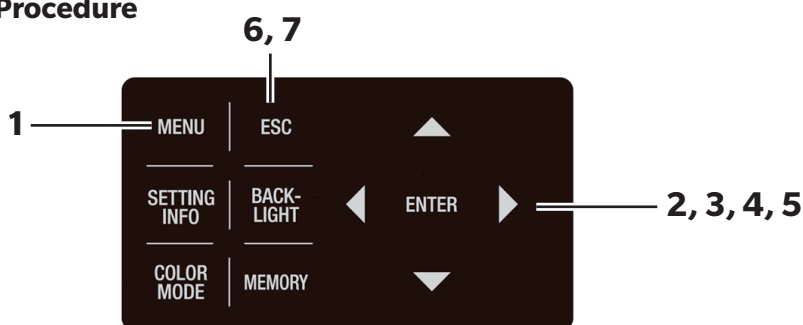

### 1. Press **MENU** key when the MEAS screen is displayed.

The **MENU screen** appears on the LCD.

When the backlight of the LCD has been turned off via

**BACKLIGHT** key on the MEAS screen, the backlight is turned on.

<MEAS SNGL>		UC00	1°
Lv	63.60	cd/m <sup>2</sup>	
X	0.4015		
Y	0.4061		
CMF	SPD	SYN[Hz]	ACC
2°	Nrm	59.94	Non

MENU	
<input type="checkbox"/>	MEAS
<input type="checkbox"/>	MEMORY
<input checked="" type="checkbox"/>	OPTION
<input type="checkbox"/>	SETUP
<input type="checkbox"/>	DARK MEASUREMENT
<input type="checkbox"/>	INFORMATION

### 2. Press either **▲** or **▼** key to select **[OPTION]** and then press **ENTER** key.

The **MENU - OPTION screen** appears on the LCD.

The current set contents are displayed in the **[EXT-ND]** item.

MENU	
OPTION(1/2)	
<input type="checkbox"/>	NEGATIVE VALUE [NO PROC]
<input type="checkbox"/>	USER CAL [OFF]
<input type="checkbox"/>	CLOSE UP [OFF]
<input checked="" type="checkbox"/>	EXT-ND [OFF]
<input type="checkbox"/>	

3. Press either  or  key to select [EXT-ND] and then press  key.

The **MENU - OPTION - EXT-ND (for selection of ND Filter)** screen appears on the LCD.

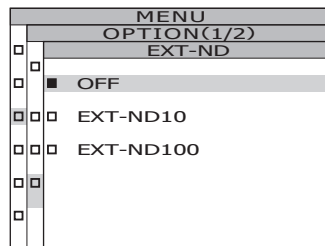

4. Press either  or  key to select [OFF] or [EXT-ND10] or [EXT-ND100].

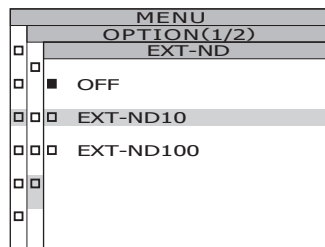

5. Press  key.

When the ND filter is set, the **MENU - OPTION** screen appears again on the LCD.

By pressing the  key, the setting is canceled and the **MENU - OPTION** screen appears again on the LCD.

The ND filter setting is saved even after the power switch is turned off (O).

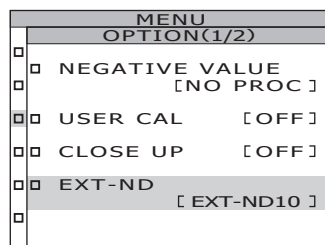

6. Press  key.

The **MENU** screen appears again on the LCD.

7. Press  key.

The **MEAS** screen appears again on the LCD.

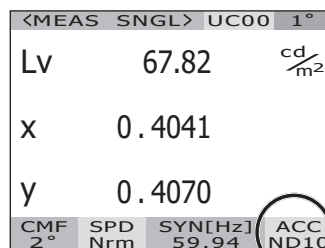

# Using the Illuminance Adapter

Use the illuminance adapter in the optional accessories to measure illuminance. For instructions on how to attach the illuminance adapter, refer to the instruction manual for the illuminance adapter. Note that the illuminance adapter comes calibrated as a set together with this instrument.

Attaching an illuminance adapter to this instrument and selecting it as an accessory enables spectral irradiance measurement with a spectrum wavelength width of 5 nm or less, and accuracy conforming to Class AA Illuminance Adapter general illuminance meter of JIS C 1609-1:2006.

When measuring, rotate the focus adjustment ring to set the focal length at infinity ( $\infty$ ). Setting a different focal length will lead to inaccurate measurement.

Setting the wrong illuminance adapter will lead to inaccurate measurement. Moreover, do not use the illuminance adapter together with the closeup lens or ND filter. as this will lead to inaccurate measurement.

Measurement illuminance range (in light source A spectrum)

Measurement angle	CS-3000HDR	CS-3000	CS-2000Plus
1°	0.01 to 1,400,000 lx	0.012 to 70,000 lx	0.08 to 70,000 lx
0.2°	0.25 to 35,000,000 lx	0.3 to 1,750,000 lx	2 to 1,750,000 lx
0.1°	1 to 140,000,000 lx	1.2 to 7,000,000 lx	8 to 7,000,000 lx

Note that in practice, light source A measurement will have an upper limit of about 100,000 lx due to the effect of heat.

## Operating Procedure

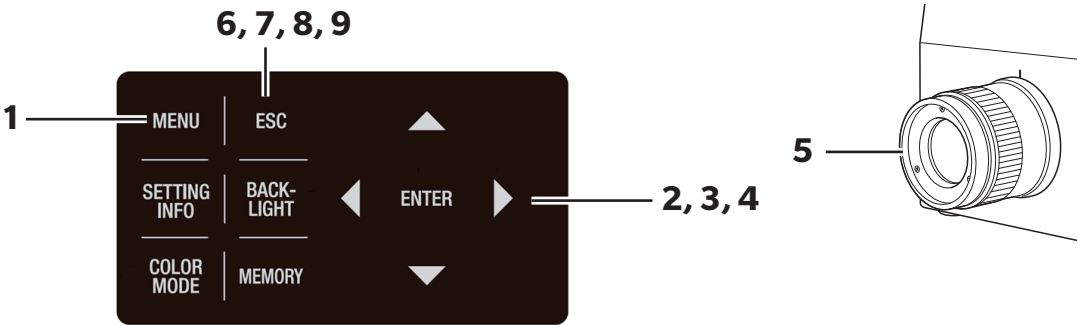

1. Press **MENU** key when the MEAS screen is displayed.

The **MENU screen** appears on the LCD.

When the backlight of the LCD has been turned off via

**BACKLIGHT** key on the MEAS screen, the backlight is turned on.

<MEAS SNGL> UC00 1°			
Lv	68.12	cd/m <sup>2</sup>	
X	0.3814		
Y	0.3909		
CMF	SPD	SYN[Hz]	ACC
2°	Nrm	59.94	Non



MENU	
<input type="checkbox"/>	MEAS
<input type="checkbox"/>	MEMORY
<input checked="" type="checkbox"/>	OPTION
<input type="checkbox"/>	SETUP
<input type="checkbox"/>	DARK MEASUREMENT
<input type="checkbox"/>	INFORMATION

2. Press either **▲** or **▼** key to select **[OPTION]** and then press **ENTER** key.

The **MENU - OPTION screen** appears on the LCD.

The current set contents are displayed in the **[ILLUMINANCE]** item.

MENU	
OPTION(2/2)	
<input checked="" type="checkbox"/>	ILLUMINANCE [OFF]
<input type="checkbox"/>	
<input type="checkbox"/>	
<input type="checkbox"/>	
<input type="checkbox"/>	

3. Press either  or  key to select [ILLUMINANCE] and then press  key.

The **MENU - OPTION - ILLUMINANCE** screen appears on the LCD.

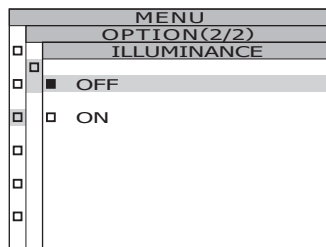

4. Press either  or  key to select [ON] and then press  key.

When the illuminance adapter is set, a caution message appears on the LCD.

By pressing the  key, the setting is canceled and the **MENU - OPTION** screen appears again on the LCD.

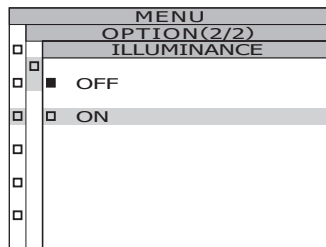

5. Rotate the focus adjustment ring to set the focal length at infinity ( $\infty$ ).

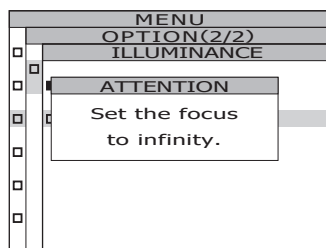

6. Press  key.

The **MENU - OPTION - ILLUMINANCE** screen appears on the LCD.

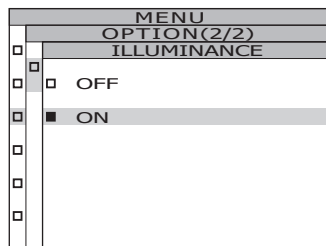

7. Press  key.

The **MENU - OPTION** screen appears on the LCD.

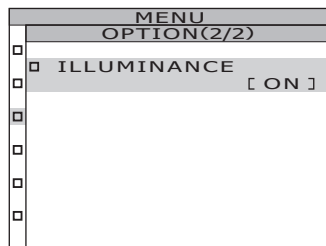

8. Press  key.

The **MENU** screen appears again on the LCD.

9. Press  key.

The **MEAS** screen appears again on the LCD.

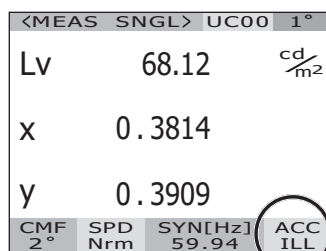

# Backlight ON/OFF During Measurement

The LCD backlight can be selectively turned on or off during measurement. Turning off the backlight can avoid LCD backlight reflection on the surrounding area during measurement, which affects the measurement value.

When pressing the BACKLIGHT key to turn off the backlight, it is turned off irrespective of the following setting.

\* Factory default setting: ON

## Operating Procedure

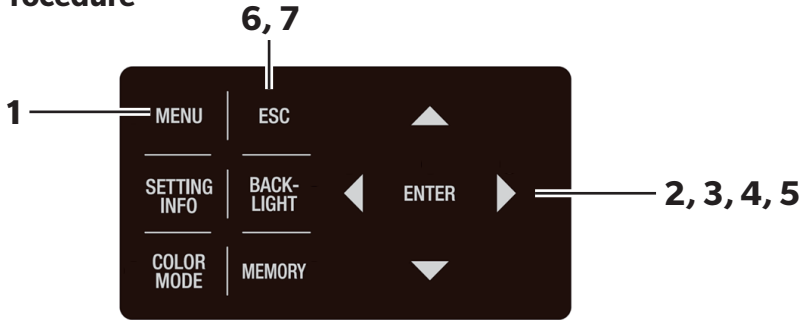

### 1. Press **MENU** key when the MEAS screen is displayed.

The **MENU** screen appears on the LCD.

When the backlight of the LCD has been turned off via **BACKLIGHT** key on the MEAS screen, the backlight is turned on.

<MEAS SNGL>		UC00	1°
Lv	63.60	cd/m <sup>2</sup>	
X	0.4015		
y	0.4061		
CMF	SPD	SYN[Hz]	ACC
2°	Nrm	59.94	Non



MENU	
<input type="checkbox"/>	MEAS
<input type="checkbox"/>	MEMORY
<input type="checkbox"/>	OPTION
<input checked="" type="checkbox"/>	SETUP
<input type="checkbox"/>	DARK MEASUREMENT
<input type="checkbox"/>	INFORMATION

### 2. Press either **▲** or **▼** key to select **[SETUP]** and then press **ENTER** key.

The **MENU - SETUP** screen appears on the LCD.

The current set contents are displayed in the **[BACKLIGHT@MEAS]** item.

MENU		SETUP(1/3)	
<input type="checkbox"/>	CMF	[ 2° ]	
<input checked="" type="checkbox"/>	BACKLIGHT@MEAS	[ ON ]	
<input checked="" type="checkbox"/>	RS-POWER SUPPLY	[ OFF ]	
<input type="checkbox"/>			
<input type="checkbox"/>			

- 3. Press either  or  key to select [BACKLIGHT@MEAS] and then press  key.**

The **MENU - SETUP - BACKLIGHT@MEAS** (to turn backlight on/off during measurement) screen appears on the LCD.

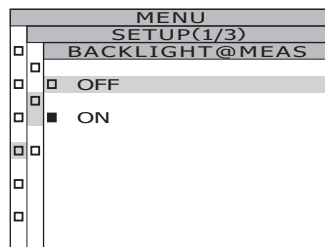

- 4. Press either  or  key to select [ON] or [OFF].**

- 5. Press  key.**

When the setting is made to turn the backlight on or off during measurement, the **MENU - SETUP** screen appears again on the LCD.

By pressing the  key, the setting is canceled and the **MENU - SETUP** screen appears again on the LCD.

Setting of backlight ON/OFF during measurement is saved even after the power switch is turned OFF (O).

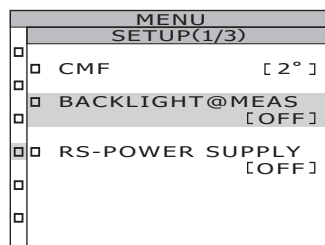

- 6. Press  key.**

The **MENU** screen appears again on the LCD.

- 7. Press  key.**

The **MEAS** screen appears again on the LCD.

# Baud Rate Selection for RS-232C Communication

The baud rate when connecting to a PC via RS-232C can be set as desired.

\* Baud rate : 1200, 2400, 4800, 9600, 19200, 38400, 57600, 115200, 230400, 460800, 921600

\* Factory default setting : 115200

**Memo** This operation is not necessary when connecting to a PC via USB. In addition, changing the baud rate setting has no effect on USB communication speeds.

## Operating Procedure

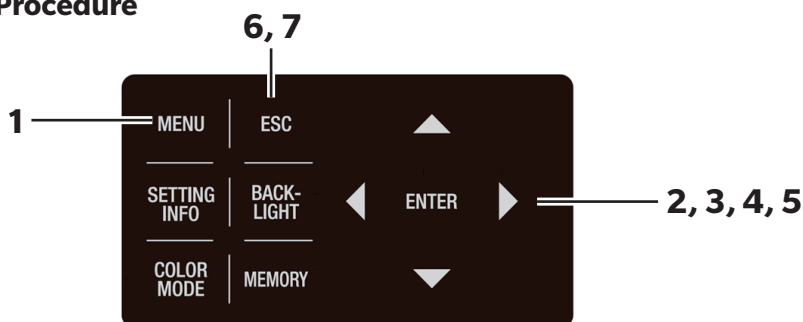

1. Press **MENU** key when the MEAS screen is displayed.

The **MENU** screen appears on the LCD.

When the backlight of the LCD has been turned off via

**BACKLIGHT** key on the MEAS screen, the backlight is turned on.

<MEAS SNGL>		UC00	1°
Lv	63.60	cd/m <sup>2</sup>	
X	0.4015		
Y	0.4061		
CMF	SPD	SYN[Hz]	ACC
2°	Nrm	59.94	Non

MENU	
<input type="checkbox"/>	MEAS
<input type="checkbox"/>	MEMORY
<input type="checkbox"/>	OPTION
<input checked="" type="checkbox"/>	SETUP
<input type="checkbox"/>	DARK MEASUREMENT
<input type="checkbox"/>	INFORMATION

2. Press either **▲** or **▼** key to select **[SETUP]** and then press **ENTER** key.

The **MENU - SETUP** screen appears on the LCD.

The current set contents are displayed in the **[RS-232C BAUDRATE]** item.

MENU SETUP(2/3)	
<input type="checkbox"/>	DATA FORM [ F ]
<input checked="" type="checkbox"/>	RS-232C BAUDRATE [ 115200bps ]
<input type="checkbox"/>	EXT VOLTAGE [ 3.3V ]
<input type="checkbox"/>	DATE TIME [ 2022/10/11 13:38:10 ]



3. Press either  or  key to select [RS-232C BAUDRATE] and then press **ENTER** key.

The **MENU - SETUP - RS-232C BAUDRATE** (for selection of RS-232C communication baud rate) screen appears on the LCD.

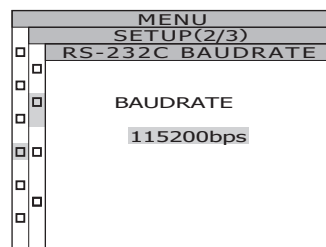

4. Press either  or  key to select the baud rate.

Press  key for a larger number.

Press  key for a smaller number.

5. Press **ENTER** key.

When the baud rate is set, the **MENU - SETUP** screen appears again on the LCD.

By pressing the **ESC** key, the setting is canceled and the **MENU - SETUP** screen appears again on the LCD.

The baud rate setting for RS-232C communication is saved even after the power switch is turned OFF (O).

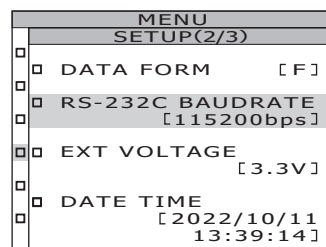

6. Press **ESC** key.

The **MENU** screen appears again on the LCD.

7. Press **ESC** key.

The **MEAS** screen appears again on the LCD.

# Setting RS-232C Power Supply

Power can be supplied (DC 6 V) to devices connected to the RS-232C terminal of this instrument. The RS-232C to Bluetooth conversion adapter is used, for example, to connect this instrument to a Bluetooth-enabled PC.

Do not enable power supply unless you are connecting a device that requires power supply.

\* Factory default setting: OFF

## Operating Procedure

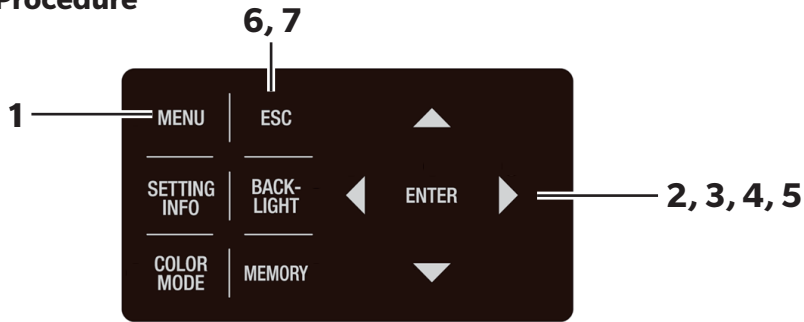

1. Press **MENU** key when the MEAS screen is displayed.

The **MENU** screen appears on the LCD.

When the backlight of the LCD has been turned off via **BACKLIGHT** key on the MEAS screen, the backlight is turned on.



<MEAS SNGL>		UC00	1°
Lv	63.60	cd/m <sup>2</sup>	
X	0.4015		
Y	0.4061		
CMF	SPD	SYN[Hz]	ACC
2°	Nrm	59.94	Non

MENU	
<input type="checkbox"/>	MEAS
<input type="checkbox"/>	MEMORY
<input type="checkbox"/>	OPTION
<input checked="" type="checkbox"/>	SETUP
<input type="checkbox"/>	DARK MEASUREMENT
<input type="checkbox"/>	INFORMATION

2. Press either **▲** or **▼** key to select **[SETUP]** and then press **ENTER** key.



The **MENU - SETUP** screen appears on the LCD.

MENU SETUP(1/3)	
<input type="checkbox"/>	CMF [ 2° ]
<input type="checkbox"/>	BACKLIGHT@MEAS [ ON ]
<input checked="" type="checkbox"/>	RS-POWER SUPPLY [ OFF ]
<input type="checkbox"/>	
<input type="checkbox"/>	

3. Press either  or  key to select [RS-POWER SUPPLY] and then press **ENTER** key.

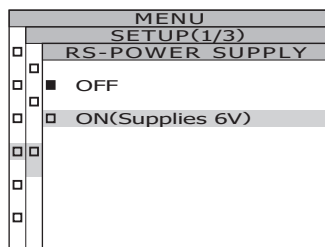
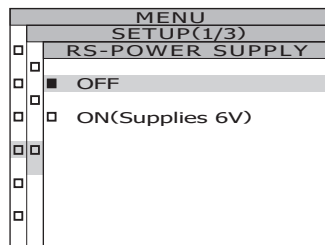

The **MENU - SETUP - RS-POWER SUPPLY** screen appears on the LCD.

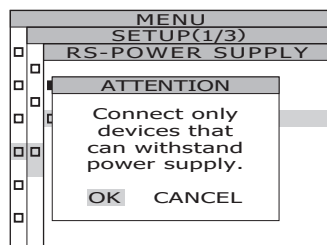

4. Press either  or  key to select [ON (Supplies 6 V)] and then press **ENTER** key.

A caution message appears on the LCD.



5. After making sure that the connected device is suitable for power supply, press either  or  key to select [OK] and then press **ENTER** key.

The **MENU - SETUP** screen appears on the LCD.

6. Press **ESC** key.

The **MENU** screen appears again on the LCD.

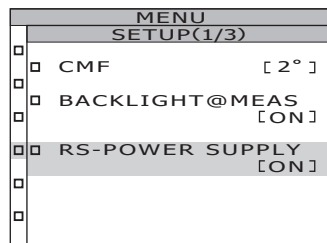

7. Press **ESC** key.

The **MEAS** screen appears again on the LCD.

# Setting Internal Clock

This instrument has an internal clock that records the date and time of measurements. Check the date and time, and if there is a discrepancy, enter the correct date and time. The date display format can also be changed.

\* Factory default setting : Time adjusted at time of shipment, Display format: YYYY/MM/DD

## Operating Procedure

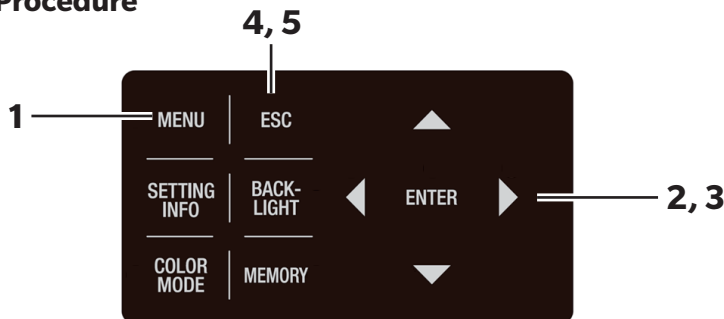

1. Press **MENU** key when the MEAS screen is displayed.

The **MENU** screen appears on the LCD.

When the backlight of the LCD has been turned off via

**BACKLIGHT** key on the MEAS screen, the backlight is turned on.

<MEAS SNGL> UC00 1°			
Lv	55.40	cd/m <sup>2</sup>	
X	0.4087		
Y	0.4188		
CMF	SPD	SYN[Hz]	ACC
2°	Nrm	59.94	Non

MENU	
<input type="checkbox"/>	MEAS
<input type="checkbox"/>	MEMORY
<input type="checkbox"/>	OPTION
<input checked="" type="checkbox"/>	SETUP
<input type="checkbox"/>	DARK MEASUREMENT
<input type="checkbox"/>	INFORMATION

2. Press either **▲** or **▼** key to select **[SETUP]** and then press **ENTER** key.

The **MENU - SETUP** screen appears on the LCD.

MENU	
SETUP(2/3)	
<input type="checkbox"/>	DATA FORM [F]
<input type="checkbox"/>	RS-232C BAUDRATE [115200bps]
<input type="checkbox"/>	EXT VOLTAGE [3.3V]
<input type="checkbox"/>	DATE TIME
	[2022/10/19 17:02:01]

Setting the date and time

- 3-a-1. Press either **▲** or **▼** key to select **[DATE TIME]** and then press **ENTER** key.

The **MENU - SETUP - DATE TIME** screen appears on the LCD.

The **date and time setting** screen appears.

MENU	
SETUP(2/3)	
DATE TIME	
<input type="checkbox"/>	YYYY / MM / DD
<input type="checkbox"/>	2022 / 10 / 19
<input type="checkbox"/>	17 : 02 : 35

**3-a-2.** Press either  or  key to move the cursor.

Press either  or  key to set date and then press  key.

Press  key for a larger number.

Press  key for a smaller number.

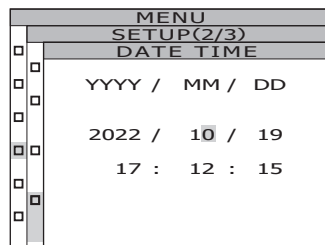

**3-a-3.** Press either  or  key to move the cursor.

Press either  or  key to set time and then press  key.

Press  key for a larger number.

Press  key for a smaller number.

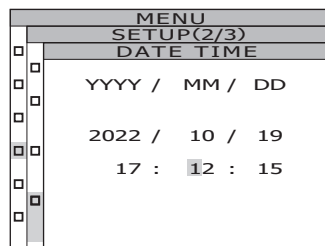

The **MENU - SETUP** screen appears again on the LCD.

The current set contents are displayed in the DATE TIME item.



.....

Changing the date display format



**3-b-1.** Press either  or  key to select **[DATE FORMAT]** and then press  key.

The **MENU - SETUP - FORMAT**

**screen** appears on the LCD.

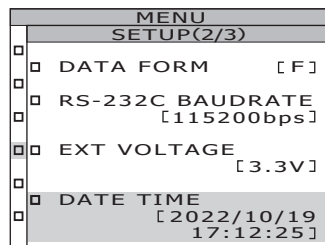
The **date and time setting** screen appears.



**3-b-2.** Press either  or  key to select **[YYYY/MM/DD]**, **[MM/DD/YYYY]** or **[DD/MM/YYYY]** and then press  key.

Press  key for a larger number.

Press  key for a smaller number.

The **MENU - SETUP** screen appears again on the LCD.

The current set contents are displayed in the DATE FORMAT item.

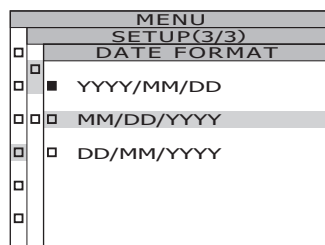
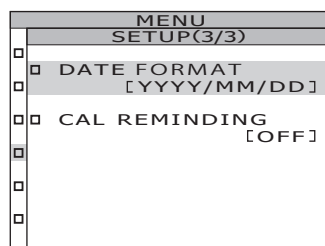

**4.** Press  key.

The **MENU** screen appears again on the LCD.

**5.** Press  key.

The **MEAS** screen appears again on the LCD.

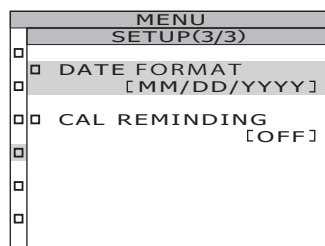

# Setting Periodic Calibration Reminders

Periodic calibration (once a year) maintains high measurement accuracy.

When the periodic calibration deadline approaches, a caution message reminding the user of the periodic calibration can be displayed at the startup of the instrument. If the reminder setting is set to [ON], a warning message will be displayed at startup when 11 months have passed since the starting point date.

\* Factory default setting: At first startup, a screen display will appear to select the reminder setting [ON] or [OFF]. If skipped, the setting will be set to [OFF].

\* The starting point date is set as the calibration date, service date, first startup date, etc.

## Operating Procedure

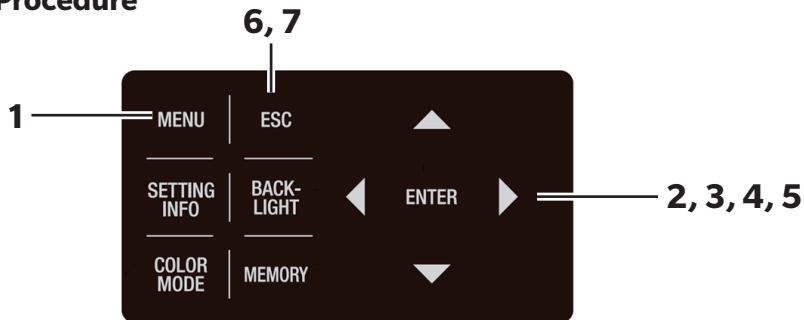

1. Press **MENU** key when the MEAS screen is displayed.

The **MENU** screen appears on the LCD.

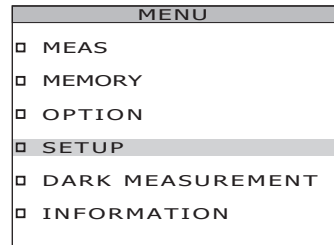
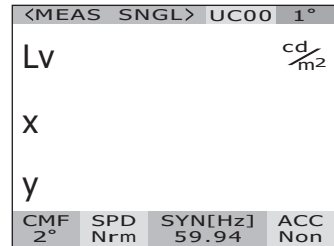

When the backlight of the LCD has been turned off via **BACKLIGHT** key on the MEAS screen, the backlight is turned on.

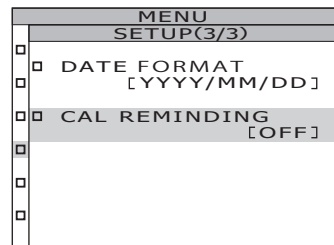

2. Press either **▲** or **▼** key to select **[SETUP]** and then press **ENTER** key.

The **MENU - SETUP** screen appears on the LCD.



- 3. Press either  or  key to select [CAL REMINDING] and then press  key.**

The **MENU - SETUP - CAL REMINDING** screen appears on the LCD.

The **reminder setting** screen appears.

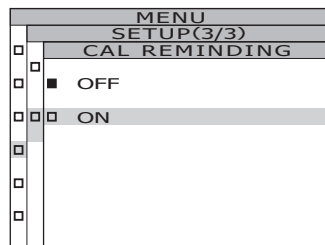

- 4. Press either  or  key to select [ON] / [OFF].**

- 5. Press  key.**

The **MENU - SETUP** screen appears again on the LCD.

By pressing the  key, the setting is canceled and the **MENU - SETUP** screen appears again on the LCD.

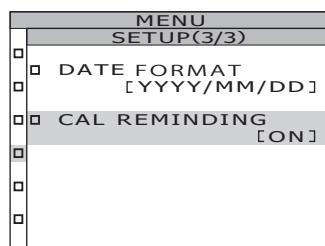

- 6. Press  key.**

The **MENU** screen appears again on the LCD.

- 7. Press  key.**

The **MEAS** screen appears again on the LCD.

# Calibration

## Calibration Channels

This instrument includes 11 calibration channels from Ch00 to Ch10.

Ch00 is for measurement based upon KONICA MINOLTA's calibration standard. Its calibration correction coefficient has been set and is unchangeable.

The following contents can be set to Ch01 to Ch10 respectively using CS-S30 software for spectroradiometers included in the instrument's standard accessories. For details on how to set up using the software, see the CS-S30 instruction manual.

- Correction coefficient of user calibration
- Correction coefficient ID

They are commonly used among each color space of  $Lvxy$ ,  $Lvu'v'$ ,  $LvTcp\Delta uv$ , XYZ, dominant wavelength/excitation purity and spectral graph in one channel.

Calibration channels can be changed using the following procedure.

## Operating Procedure

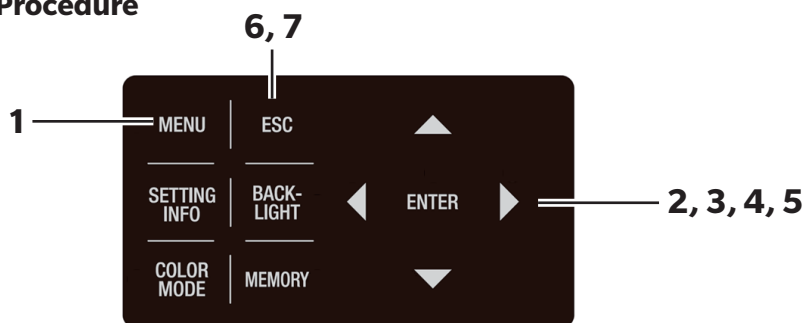

### 1. Press **MENU** key when the MEAS screen is displayed.

The **MENU** screen appears on the LCD.

When the backlight of the LCD has been turned off via

**BACKLIGHT** key on the MEAS screen, the backlight is turned on.

<MEAS SNGL> UC00 1°			
Lv	63.60	cd/m <sup>2</sup>	
X	0.4015		
y	0.4061		
CMF	SPD	SYN[Hz]	ACC
2°	Nrm	59.94	Non

MENU	
<input type="checkbox"/>	MEAS
<input type="checkbox"/>	MEMORY
<input checked="" type="checkbox"/>	OPTION
<input type="checkbox"/>	SETUP
<input type="checkbox"/>	DARK MEASUREMENT
<input type="checkbox"/>	INFORMATION



**2. Press either  $\blacktriangle$  or  $\blacktriangledown$  key to select [OPTION] and then press **ENTER** key.**

The **MENU - OPTION** screen appears on the LCD.

The current set contents are displayed in the **[USER CAL]** item.

MENU	
OPTION(1/2)	
<input type="checkbox"/>	NEGATIVE VALUE [NO PROC]
<input checked="" type="checkbox"/>	USER CAL [OFF]
<input type="checkbox"/>	CLOSE UP [OFF]
<input type="checkbox"/>	EXT-ND [OFF]

**3. Press either  $\blacktriangle$  or  $\blacktriangledown$  key to select [USER CAL] and then press **ENTER** key.**

The **MENU - OPTION - USER CAL (for selection of calibration channel)** screen appears on the LCD.

The calibration channel number and compensation coefficient ID (maximum of 10 characters) are displayed. In the case of Ch00, "NON" is displayed.

MENU	
OPTION(1/2)	
USER CAL	
CAL NO.	
[ OFF ]	

**4. Press either  $\blacktriangle$  or  $\blacktriangledown$  key to select a channel.**

Press  $\blacktriangle$  key for a larger number.

Press  $\blacktriangledown$  key for a smaller number.

The calibration channel selectable range is OFF and 01 to 10.

MENU	
OPTION(1/2)	
USER CAL	
CAL NO.	
[ AB-X 03 ]	

**5. Press **ENTER** key.**

When the calibration channel is set, the **MENU - OPTION** screen appears again on the LCD.

If a calibration channel without set correction factor is selected, it cannot be set.

By pressing the **ESC** key, the setting is canceled and the **MENU - OPTION** screen appears again on the LCD.

The calibration channel setting is saved even after the power switch is turned OFF (O).

MENU	
OPTION(1/2)	
<input type="checkbox"/>	NEGATIVE VALUE [NO PROC]
<input checked="" type="checkbox"/>	USER CAL [ 03 ]
<input type="checkbox"/>	CLOSE UP [OFF]
<input type="checkbox"/>	EXT-ND [OFF]

**6. Press **ESC** key.**

The **MENU** screen appears again on the LCD.

**7. Press **ESC** key.**

The **MEAS** screen appears again on the LCD.

MENU	
OPTION(1/2)	
UC03	
Lv	63.60 $\frac{cd}{m^2}$
x	0.4015
y	0.4061
CMF	2°
SPD	Nrm
SYN[Hz]	59.94
ACC	Non

# Checking Main Unit Information

Instrument information such as product name, main unit version, and serial number can be checked.

## Operating Procedure

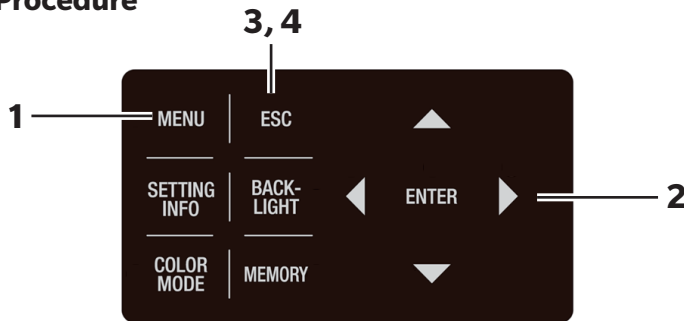

1. Press **MENU** key when the MEAS screen is displayed.

The **MENU** screen appears on the LCD.

When the backlight of the LCD has been turned off via

**BACKLIGHT** key on the MEAS screen, the backlight is turned on.

<MEAS SNGL> UC00 1°			
LV			cd/m <sup>2</sup>
X			
y			
CMF 2°	SPD SF1	SYN[Hz] 60.05	ACC Non

MENU	
<input type="checkbox"/>	MEAS
<input type="checkbox"/>	MEMORY
<input type="checkbox"/>	OPTION
<input type="checkbox"/>	SETUP
<input type="checkbox"/>	DARK MEASUREMENT
<input type="checkbox"/>	INFORMATION

2. Press either **▲** or **▼** key to select **[INFORMATION]** and then press **ENTER** key.

The **MENU - INFORMATION** screen appears on the LCD.

Information such as product name, main unit version, and serial number can be checked.

MENU INFORMATION	
<input type="checkbox"/>	KONICA MINOLTA, INC. (C)2021
<input type="checkbox"/>	SPECTRORADIOMETER CS-3000HDR
<input type="checkbox"/>	
<input type="checkbox"/>	S/N 3000104
<input type="checkbox"/>	VER.1.00.0000

3. Press **ESC** key.

The **MENU** screen appears again on the LCD.

4. Press **ESC** key.

The **MEAS** screen appears again on the LCD.

# Measurement

# Measurement

## Operating Procedure

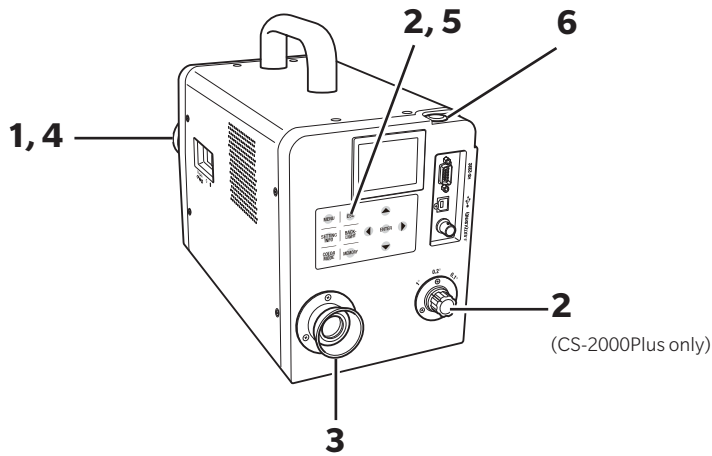

- 1. Decide whether to attach an optional accessory or not depending on the object to be measured and details of the desired measurement.**
- 2. The measurement angle is set to  $1^\circ$ ,  $0.2^\circ$ , or  $0.1^\circ$  depending on the size of the object to be measured and the measurement distance.**
- 3. Rotate the finder's diopter adjustment ring to adjust the diopter.**

Adjust so that the aperture (black circle indicating measuring area) looks clear when observing the measurement object through the finder. (See p. 15)

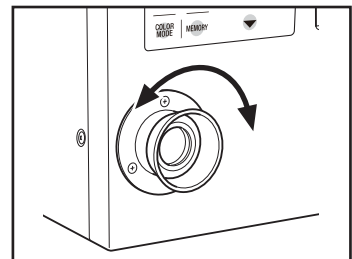

#### 4. Rotate the focus adjustment ring on the objective lens to adjust the focus.

To rotate the focus adjustment ring, loosen the screw fixing the objective lens.

Adjust so that the image of the object around the aperture looks clear when observing the measurement object through the finder.

Only the part of the object to be measured should fit into the aperture. If the aperture contains extra parts that are not to be measured, correct measurements cannot be taken.

When measuring illuminance, rotate the focus adjustment ring to set the focal length at infinity ( $\infty$ ).

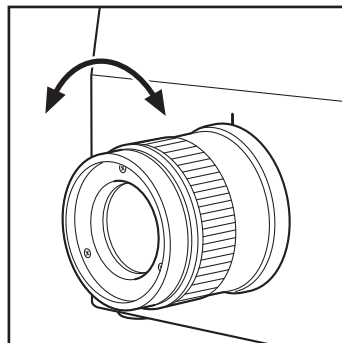

#### 5. When the MENU or MEMORY screen is displayed, press **ESC** key to switch to the MEAS screen.

The **MEAS (Measurement Value) screen** appears on the LCD.

##### [Checking measurement conditions]

Pressing the **SETTING INFO** key during the **MEAS (Measurement Value) screen** enables the currently set measurement conditions to be checked. By pressing the **ESC** key, the **MEAS screen** appears again.

<MEAS SNGL> UC00 1°			
Lv			cd/m <sup>2</sup>
X			
Y			
CMF 2°	SPD Nrm	SYN[Hz] 59.94	ACC Non

#### 6. Press the measurement button (MEASURE).

When the measurement time is long, the measurement progress bar is displayed on the LCD until measurement is completed.

If the measurement time is set to options other than **[MANUAL]**, the measurement time will be determined after the approximate luminance is checked inside the measurement device. For this reason, it may take several seconds until the measurement time appears. The displayed time shows approximately how long it will take from the point of time display to the end of measurement. If the measurement time determined from the approximate luminance is short, the remaining time will not be displayed.

Display during measurement  
(Single measurement / when measurement time is long)

<MEAS SNGL> UC00 1°			
<b>MEASURING</b>			
<div style="display: flex; align-items: center;"> <div style="width: 50px; height: 10px; background-color: gray; margin-right: 5px;"></div> <div style="border: 1px solid black; padding: 2px;">184s</div> </div>			
<ESC : STOP>			
CMF 2°	SPD Nrm	SYN[Hz] 59.94	ACC Non

(Single measurement / when measurement time is short)

<MEAS SNGL> UC00 1°			
Lv	63.60		cd/m <sup>2</sup>
X	0.4015		
Y	0.4061		
CMF 2°	SPD Nrm	SYN[Hz] 59.94	ACC Non

### [Continuous Measurement]

When the measurement button is pressed and held for two or more seconds, continuous measurement is conducted.

When the measurement time is long, the measurement progress bar appears on the LCD with the latest measurement value. The displayed time shows the remaining time, same as for the single measurement.

When the measurement time is short, the measurement progress bar does not appear, but the measurement value is sequentially updated and displayed.

Measurement is stopped when the **[ESC]** key is pressed during continuous measurement. In this case, the measurement that is ongoing when the **[ESC]** key is pressed will be canceled, and the last obtained measurement value will be displayed. If the **[ESC]** key is pressed in the middle of the first measurement, the measurement value will not be displayed.

When the **[ENTER]** key is pressed while the measurement value is displayed, the measurement properties are displayed so that the measurement conditions can be confirmed. When the measurement button or a random key is pressed, the **MEAS screen** appears again.

Display during measurement  
(Continuous measurement /  
when measurement time is long)

<MEAS CONT> UC00 1°			
<b>MEASURING</b>			
		184s	
<ESC : STOP>			
Lv	0.00003	$\text{cd/m}^2$	
x	0.3681		
y	0.3726		
CMF	SPD	SYN[Hz]	ACC
2°	Nrm	59.94	Non

(Continuous measurement /  
when measurement time is  
short)

<MEAS SNGL> UC00 1°			
Lv	63.60	$\text{cd/m}^2$	
x	0.4015		
y	0.4061		
CMF	SPD	SYN[Hz]	ACC
2°	Nrm	59.94	Non

PROPERTIES(1/3)	
<MEASURE>	
DATE	[2022/10/11 14:36:51]
SPEED	[NORMAL]
INTEG TIME	[91991 .992ms]
IN-ND	[OFF]
SYNC	[INT 59.94Hz]

# Saving Measurement Values

This instrument can save 100 measurement values with designated numbers from 00 to 99.

## Operating Procedure

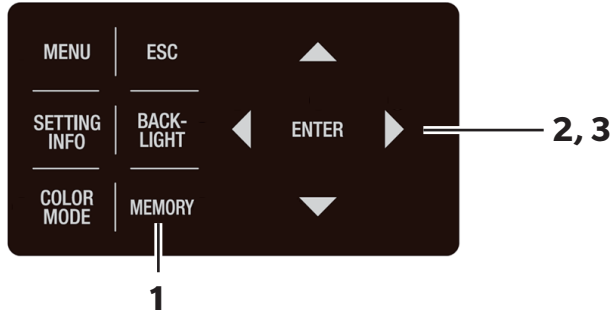

1. When the MEAS screen is displayed, press **MEMORY** key to switch to the MEMORY screen.

The **MEMORY (Measurement Value)** screen appears on the LCD.

The memory data number 00 is displayed.

<MEMORY>			
<MEASURE>			
Lv	54.22		cd/m <sup>2</sup>
x	0.4045		
y	0.4073		
<MEMORY 00>			
Lv	7.285		cd/m <sup>2</sup>
x	0.1700		
y	0.0938		
CMF	SPD	SYN[Hz]	ACC
2°	Nrm	59.94	Non

2. Press either **▲** or **▼** key to select the number of memory data to which the measurement value is saved.

Press **▲** key for a larger number.

Press **▼** key for a smaller number.

<MEMORY>			
<MEASURE>			
Lv	54.22		cd/m <sup>2</sup>
x	0.4045		
y	0.4073		
<MEMORY 10>			
Lv			cd/m <sup>2</sup>
x			
y			
CMF	SPD	SYN[Hz]	ACC
2°	Nrm	59.94	Non

3. Press **ENTER** key.

If a measurement value has already been registered for the selected number, the display switches to the confirmation screen for overwriting. To overwrite it, select **[OK]**. To cancel it, select **[CANCEL]** and press **ENTER** key. Once it is overwritten, it cannot be restored to the state before the overwrite. Check the memory data number carefully before overwriting it. Measured values are saved in the selected number.

By pressing **ESC** key, saving is canceled and the **MEAS screen** appears again on the LCD.

<MEMORY>			
<MEASURE>			
Lv	54.22		cd/m <sup>2</sup>
x	0.4045		
y	0.4073		
<MEMORY 10>			
Lv	54.22		cd/m <sup>2</sup>
x	0.4045		
y	0.4073		
CMF	SPD	SYN[Hz]	ACC
2°	Nrm	59.94	Non

Follow the procedure below to display the memory data properties (measurement conditions).

## Operating Procedure

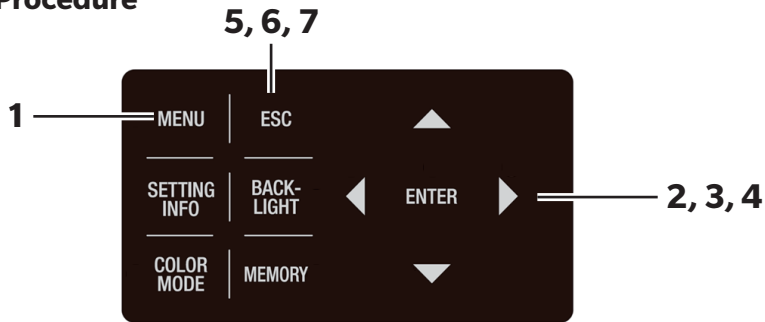

1. Press **MENU** key when the MEAS screen is displayed.

The **MENU** screen appears on the LCD.

When the backlight of the LCD has been turned off via **BACKLIGHT** key on the MEAS screen, the backlight is turned on.

<MEAS SNGL> UC00 1°			
Lv	55.91	$\frac{\text{cd}}{\text{m}^2}$	
X	0.4043		
Y	0.4073		
CMF	SPD	SYN[Hz]	ACC
2°	Nrm	59.94	Non

MENU	
<input type="checkbox"/>	MEAS
<input checked="" type="checkbox"/>	MEMORY
<input type="checkbox"/>	OPTION
<input type="checkbox"/>	SETUP
<input type="checkbox"/>	DARK MEASUREMENT
<input type="checkbox"/>	INFORMATION

2. Press either **▲** or **▼** key to select **[MEMORY]** and then press **ENTER** key.

The **MENU - MEMORY** screen appears on the LCD.

MENU MEMORY	
<input type="checkbox"/>	DELETE
<input checked="" type="checkbox"/>	PROPERTIES
<input type="checkbox"/>	
<input type="checkbox"/>	
<input type="checkbox"/>	

3. Press either **▲** or **▼** key to select **[PROPERTIES]** and then press **ENTER** key.

The **MENU - MEMORY - PROPERTIES** (for confirming memory data measurement conditions) screen appears on the LCD.

The memory data number 00 is displayed.

MENU MEMORY PROPERTIES(1/3)	
<input checked="" type="checkbox"/>	<MEMORY 00>
<input checked="" type="checkbox"/>	DATE [2021/08/26 11:12:56]
<input checked="" type="checkbox"/>	SPEED [MANUAL]
<input checked="" type="checkbox"/>	INTEG TIME [ 77.038ms]
<input checked="" type="checkbox"/>	IN-ND [OFF]



**4. To display the memory data for another number, press either ◀ or ▶ key to change the memory data number.**

The properties of the selected memory data are displayed, and the measurement conditions can be confirmed.

Press ▶ key for a larger number.

If kept pressed, the value continuously changes.

Press ◀ key for a smaller number.

If kept pressed, the value continuously changes.

Press either ▲ or ▼ key to page through properties and check measurement conditions.

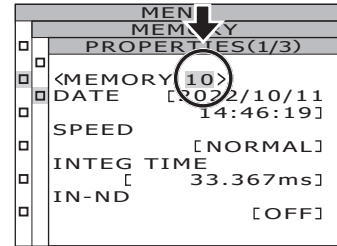

**5. Press [ESC] key.**

The **MENU - MEMORY** screen appears again on the LCD.

**6. Press [ESC] key.**

The **MENU** screen appears again on the LCD.

**7. Press [ESC] key.**

The **MEAS** screen appears again on the LCD.

# Confirming Memory Data

Follow the procedure below to confirm the saved measurement values.

## Operating Procedure

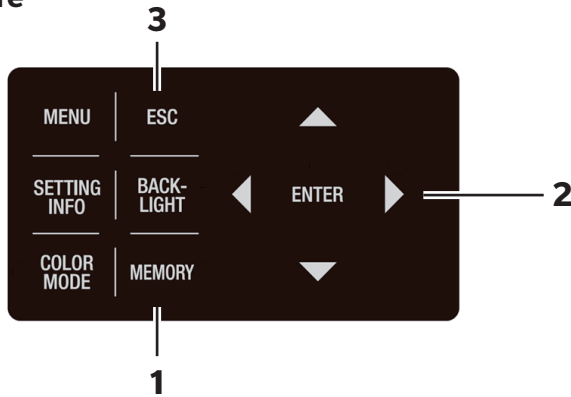

1. When the MEAS screen is displayed, press **MEMORY** key to switch to the **MEMORY** screen.

The **MEMORY (Measurement Value)** screen appears on the LCD.

The memory data number 00 is displayed.

<MEMORY>			
<MEASURE>			
Lv	54.22		cd/m <sup>2</sup>
x	0.4045		
y	0.4073		
<MEMORY 00>			
Lv	7.285		cd/m <sup>2</sup>
x	0.1700		
y	0.0938		
CMF	SPD	SYN[Hz]	ACC
2°	Nrm	59.94	Non

2. Press either **▲** or **▼** key to confirm the measurement value stored at the number of memory data.

Press **▲** key for a larger number.

Press **▼** key for a smaller number.

<MEMORY>			
<MEASURE>			
Lv	54.22		cd/m <sup>2</sup>
x	0.4045		
y	0.4073		
<MEMORY 10>			
Lv	54.22		cd/m <sup>2</sup>
x	0.4045		
y	0.4073		
CMF	SPD	SYN[Hz]	ACC
2°	Nrm	59.94	Non

3. Press **ESC** key.

The **MEAS** screen appears again on the LCD.

# Deleting Memory Data

Follow the procedure below to delete the saved measurement values.

## Operating Procedure

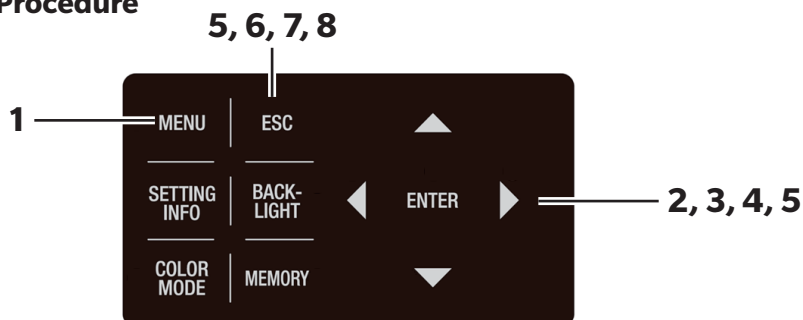

1. Press **MENU** key when the MEAS screen is displayed.

The **MENU** screen appears on the LCD.

When the backlight of the LCD has been turned off via **BACKLIGHT** key on the MEAS screen, the backlight is turned on.

<MEAS SNGL> UC00 1°			
Lv	57.12	cd/m <sup>2</sup>	
X	0.4045		
Y	0.4085		
CMF	SPD	SYN[Hz]	ACC
2°	Nrm	59.94	Non

MENU	
<input type="checkbox"/>	MEAS
<input checked="" type="checkbox"/>	MEMORY
<input type="checkbox"/>	OPTION
<input type="checkbox"/>	SETUP
<input type="checkbox"/>	DARK MEASUREMENT
<input type="checkbox"/>	INFORMATION

2. Press either **▲** or **▼** key to select **[MEMORY]** and then press **ENTER** key.

The **MENU - MEMORY** screen appears on the LCD.

MENU MEMORY	
<input checked="" type="checkbox"/>	DELETE
<input type="checkbox"/>	PROPERTIES
<input type="checkbox"/>	
<input type="checkbox"/>	
<input type="checkbox"/>	

3. Press either **▲** or **▼** key to select **[DELETE]** and then press **ENTER** key.

The **MENU - MEMORY - MEM.DELETE (for deleting memory data)** screen appears on the LCD.

The memory data number 00 is displayed.

MENU MEMORY MEM.DELETE	
<input checked="" type="checkbox"/>	MEM.DATA NO.00
<input type="checkbox"/>	
<input type="checkbox"/>	Lv 7.2845E+0
<input type="checkbox"/>	X 0.1700
<input type="checkbox"/>	Y 0.0938
<input type="checkbox"/>	
<input type="checkbox"/>	

#### 4. Press either or key to select the number of the memory data to be deleted.

Press  key for a larger number. If kept pressed, the value continuously changes. [ALL] is displayed after No.99.

Press  key for a smaller number. If kept pressed, the value continuously changes. [ALL] is displayed after No.00.

Once deleted, it cannot be restored to the state before the deletion. Check the memory data number carefully before deleting it.

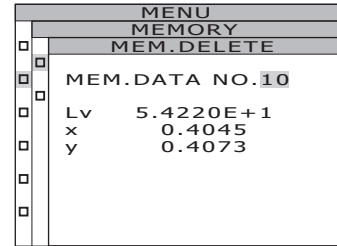

Deleting saved data, one by one

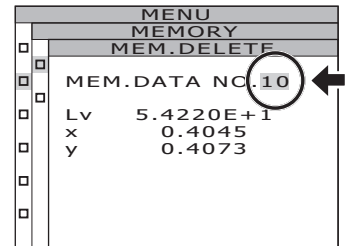

#### 5-a-1. When deleting saved data one by one: Select the number of the memory data to be deleted and press key.

The **MENU - MEMORY - MEM.DELETE - DELETE** (deletion confirmation) screen appears on the LCD.



#### 5-a-2. Press key to select [OK], and then press key.

The saved measurement values are deleted and the **MENU - MEMORY - MEM.DELETE** screen appears again on the LCD.

By selecting [CANCEL] and pressing either  key or  key, the deletion is canceled and the **MENU - MEMORY - MEM.DELETE** screen appears again on the LCD.

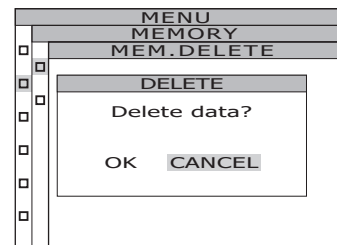

#### 5-a-3. Press key.

The **MENU - MEMORY** screen appears again on the LCD.

When collectively deleting all memory data:

**5-b-1. Select [ALL] and press **ENTER** key.**

The **MENU - MEMORY - MEM.DELETE** screen appears on the LCD.

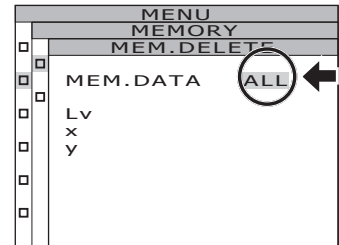

**5-b-2. Press **OK** key to select [OK], and then press **ENTER** key.**

All memory data is deleted, and the **MENU - MEMORY - MEM.DELETE** screen appears again on the LCD.

By selecting **[CANCEL]** and pressing either **ENTER** key or **ESC** key, deletion of all memory data is canceled and the **MENU - MEMORY - MEM.DELETE** screen appears again on the LCD.

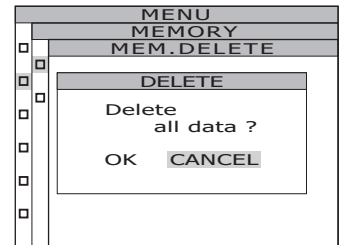

**6. Press **ESC** key.**

The **MENU - MEMORY** screen appears again on the LCD.

**7. Press **ESC** key.**

The **MENU** screen appears again on the LCD.

**8. Press **ESC** key.**

The **MEAS** screen appears again on the LCD.



# Communication

# Connecting to a PC

This instrument can be used together with a PC for mutual communication. To communicate with a PC, use the included USB cable (2 m) CS-A32 or an optional RS-232C cable (IF-A37/38).

**Memo** Simultaneous use of USB communication and RS communication is not possible.

## Connection via USB cable

The USB cable can be plugged/unplugged while power is on, but it is recommended to switch power off in this case.

**Memo** Make sure to attach the RS-232C connector cap. Failure to do so may cause malfunction due to static electricity.

## Operating Procedure

- 1. Slide power switch to OFF (O).**
- 2. Connect the USB cable to the USB connector of this instrument.**
- 3. Make sure that the USB cable is firmly connected to the USB connector.**

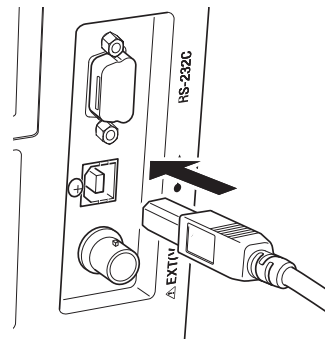

Communication interface in this instrument conforms to USB 2.0.

Hold the USB cable plug when unplugging it. Do not pull the cord.

Plug the USB cable to fit the connector entry point.

To connect this instrument to a PC, install the corresponding USB driver software. The USB driver is attached to the CS-S30 software for spectroradiometers included in the standard accessories. See the CS-S30 installation guide for details on installing the USB driver software in a PC.



## Connection via RS-232C cable

Before setting the power switch to ON (|), connect an RS-232C cable (9-pin D-sub) to the RS-232C connector on the instrument.

The RS-232C connector on the instrument is a 9-pin D-sub male connector. Use a cross cable for the connector.

### Operating Procedure

- 1. Slide power switch to OFF (O).**
- 2. Connect the instrument to the PC using an RS-232C cable.**
- 3. Make sure that the cable is firmly connected to the RS-232C connector with the connector's right and left screws.**

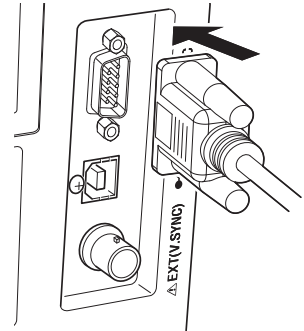

When disconnecting the RS-232C cable, slide power switch to OFF (O) first, and unplug the cable while holding the plug. Do not pull the cord.

Baud rate	1200/2400/4800/9600/19200/38400/57600/115200/230400/460800/ 921600
Data length	8 bits
Parity	None
Stop bit	1 bit
Flow control	Hardware (RTS/CTS)

Pin arrangement

Device side

PC side

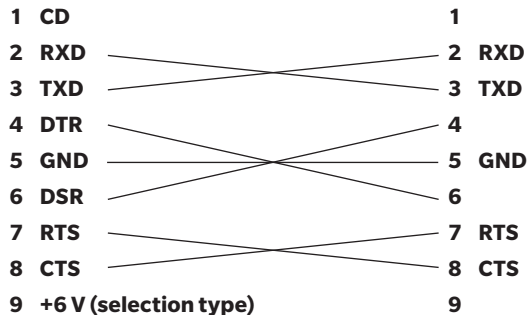
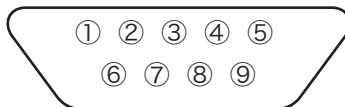

**Cross cable**

---

## Connection via RS-232C Bluetooth Conversion Adapter

By using the commercially-available RS-232C Bluetooth conversion adapter, the instrument can be connected to a Bluetooth-enabled PC.

Before setting the power switch to ON (|), connect an RS-232C Bluetooth conversion adapter (9-pin D-sub) to the RS-232C connector.

### Operating Procedure

- 1. Slide power switch to OFF (O).**
- 2. Connect an RS-232C Bluetooth conversion adapter to the RS-232C connector.**
- 3. Make sure that the cable is firmly connected to the RS-232C connector with the connector's right and left screws.**
- 4. Enables power supply from the main unit to the RS-232C Bluetooth conversion adapter.**

See Setting RS-232C Power Supply (p.60) for the information on how to enable the power supply.

For details on settings to communicate with a PC, see the RS-232C Bluetooth conversion adapter's instruction manual.



Check whether the power supply is applicable to the equipment to be used. Never supply power to the equipment that does not meet the specifications, as this may cause malfunctions.

<Power supply>

Output voltage: 5.62 to 6.14 V, Output current: 150 mA max.

# Remote Mode

Remote mode refers to sending the command from a PC to this instrument while both are connected.

If this instrument is controlled with a PC, **“REMOTE MODE”** appears on the LCD. While this message is displayed, key operation of this instrument is not acceptable except for the following cases.

- If the measurement button is pressed, measurement starts to forward the data to a PC. (If that measurement button is in valid mode by transferring the command from a PC to this instrument. Use the software for spectroradiometers detailed below.)
- When **ESC** key is pressed, the remote mode is canceled.

To control this instrument by a PC, use the CS-S30 software for spectroradiometers included in the standard accessories. For details on CS-S30 specifications and use method, see the CS-S30 instruction manual.

If you want to use an independent program on a PC to control this instrument, download Communication Specifications from KONICA MINOLTA's website at URL below for your reference:

<https://www.konicaminolta.com/instruments/download/software/display/index.html>

(The above URL is subject to change without notice.)

(If the target page does not appear, please search the site by keywords, “CS-3000” and “download.”)

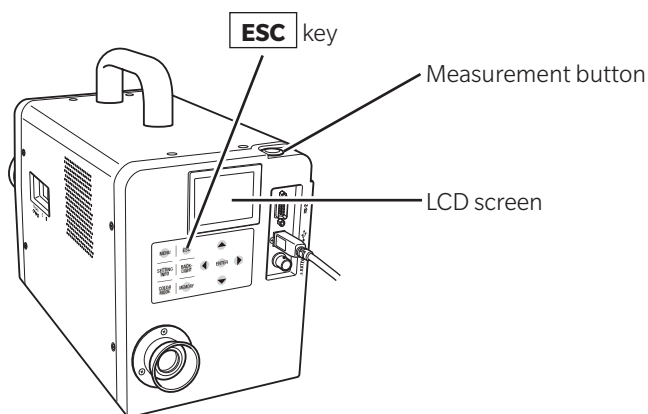

**Memo** Use the USB cable when controlling the instrument with CS-S30.



# **Explanation**

# Measurement Principles

Light energy passes through the objective lens. The lights from the measurement area pass through the hole in the center of the aperture mirror to the optical fiber, while the remaining light is guided to the finder optics by the aperture mirror. As a result, the part equivalent to the measurement area looks like a black circle when observed through the finder.

The light entering the optical fiber is reflected repeatedly so that it is mixed and becomes virtually uniform. It then passes through the collimator lens to the plane diffraction grating.

After being dispersed by the grating, the light is focused by the condenser lens according to wavelength, and an array sensor is located at this focus point.

The amount of detected energy for each wavelength is then converted to a digital value by an A/D converter, based on which, the spectral radiant luminance and chromaticity are calculated.

## Sensor Section

The sensor section has a photo diode array consisting of 512 elements. The array is always kept at constant temperature using a Peltier cooler, irrespective of the ambient temperature. This can reduce dark current and improve S/N ratio of the sensor, thus enabling measurement of low luminance.

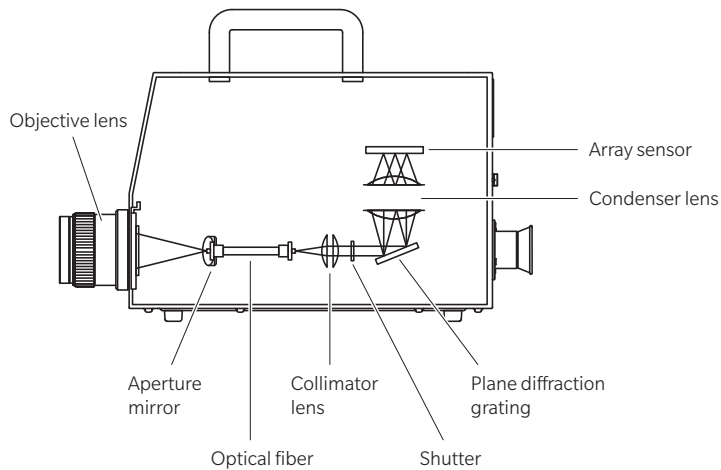

# Dark Measurement

---

Each measurement consists of “light measurement” and “dark measurement.”

“Light measurement” is performed with light from the object irradiating the sensor, while “dark measurement” is performed with no light from the object irradiating the sensor to measure dark current.

The final measured data is obtained by subtracting the measured data obtained in “dark measurement” from the one obtained in “light measurement.” This method eliminates influences of the dark current of the sensor itself, resulting in improved measurement accuracy.

## **Dark measurement modes**

The following two modes are available for dark measurement with this instrument.

**[STANDARD DARK]** Measurement mode with dark measurement each time a measurement is taken

**[INTELLIGENT DARK]** Measurement mode that corrects dark measurement values using correction information from the sensor section while skipping dark measurements  
Shortens measurement time while maintaining high accuracy.

\* Factory default setting: [NORMAL, FAST, MANUAL, MULTI-NORMAL, MULTI-FAST] STANDARD DARK  
[SUPER-FAST1, SUPER-FAST2] INTELLIGENT DARK

## ■ Measurements in [INTELLIGENT DARK]

If the measurement conditions are changed after “dark measurement” is performed, perform the “dark measurement” again.

If any of the following conditions occur during measurement, a “caution message” will appear on the screen and measurement will stop.

- (1) The last “dark measurement” was made within 20 minutes of startup **[Caution: Warm-up not completed]**
- (2) When more than 8 hours have elapsed since the last “dark measurement” **[Caution: Long time after last DARK]**
- (3) When there is a difference of 6°C or more compared to the temperature at the last “dark measurement” **[Warning: Temperature changed after last DARK]**

If a caution message appears, you are recommended to perform a “dark measurement” and resume measurement.

You can also choose to ignore the caution message to continue the measurement. If you choose to ignore the caution message, the previous “dark measurement” value will be applied.

## Performing Dark Measurement

### Operating Procedure

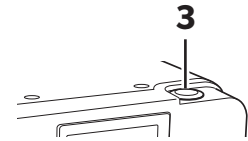
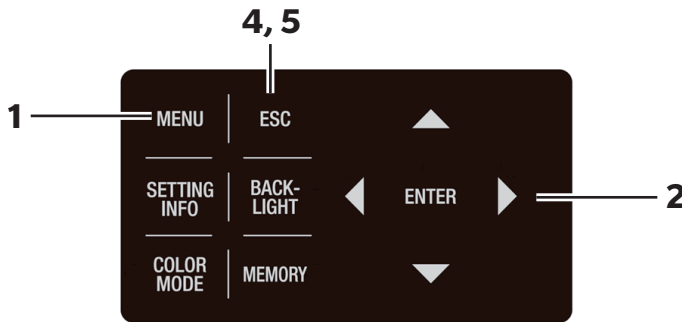

#### 1. Press **MENU** key when the MEAS screen is displayed.

The **MENU** screen appears on the LCD.

When the backlight of the LCD has been turned off via

**BACKLIGHT** key on the MEAS screen, the backlight is turned on.

<MEAS SNGL> UC00 1°			
LV			cd/m <sup>2</sup>
X			
Y			
CMF 2°	SPD Nrm	SYN[Hz] 59.94	ACC Non

MENU	
<input type="checkbox"/>	MEAS
<input type="checkbox"/>	MEMORY
<input type="checkbox"/>	OPTION
<input type="checkbox"/>	SETUP
<input checked="" type="checkbox"/>	DARK MEASUREMENT
<input type="checkbox"/>	INFORMATION

#### 2. Press either **▲** or **▼** key to select **[DARK MEASUREMENT]**, and then select **ENTER** key.

The **MENU - DARK MEASUREMENT** screen appears on the LCD.

The date and time of the last “dark measurement” can be checked.

MENU	
DARK MEASUREMENT	
<input type="checkbox"/>	
<input type="checkbox"/>	2022/10/20 17:33:48
<input type="checkbox"/>	<MEAS:MEASURE DARK>
<input type="checkbox"/>	
<input type="checkbox"/>	

#### 3. Press the measurement button (**MEASURE**).

Dark measurement is performed. After the measurement, the date and time of the measurement are displayed.

MENU	
DARK MEASUREMENT	
<input type="checkbox"/>	
<input type="checkbox"/>	2022/10/20 18:04:57
<input type="checkbox"/>	<MEAS:MEASURE DARK>
<input type="checkbox"/>	
<input type="checkbox"/>	

#### 4. Press **ESC** key.

The **MENU** screen appears again on the LCD.

#### 5. Press **ESC** key.

The **MEAS** screen appears again on the LCD.



# L<sub>v</sub>T<sub>cp</sub>Δuv

The following factors can be acquired as measurement value with L<sub>v</sub>T<sub>cp</sub>Δuv as color space of this instrument.

- L<sub>v</sub> : Luminance
- T<sub>cp</sub> : Correlated color temperature
- Δuv : Color difference from black body locus

In L<sub>v</sub>T<sub>cp</sub>Δuv, while L<sub>v</sub> stands for luminance, T<sub>cp</sub> and Δuv stand for color.

## <Relation between correlated color temperature T<sub>cp</sub> and color difference from black body locus Δuv>

Color temperature refers to the temperature of black body (perfect radiator) which has equal chromaticity coordinates to certain light. However, color temperature only represents colors on black body locus.

A slightly wider interpretation of color temperature, correlated color temperature covers those which are slightly outside the range of that of black body locus.

If a certain color positions on the isothermperature line, the intersection point of isothermperature line and black body locus is indicated as correlated color temperature for the color. Isothermperature line means a line on chromaticity coordinates which is a set of colors visually close to color temperature on black body locus. However, since all colors on a color-matching temperature line are represented with equal correlated color temperature, it is not possible to describe color only with correlated color temperature. To solve this problem, Δuv, deviation of correlated color temperature T from black body locus, is to apply for that purpose.

If Δuv exists above the black body locus, it is represented by "+," and by "-" when below.

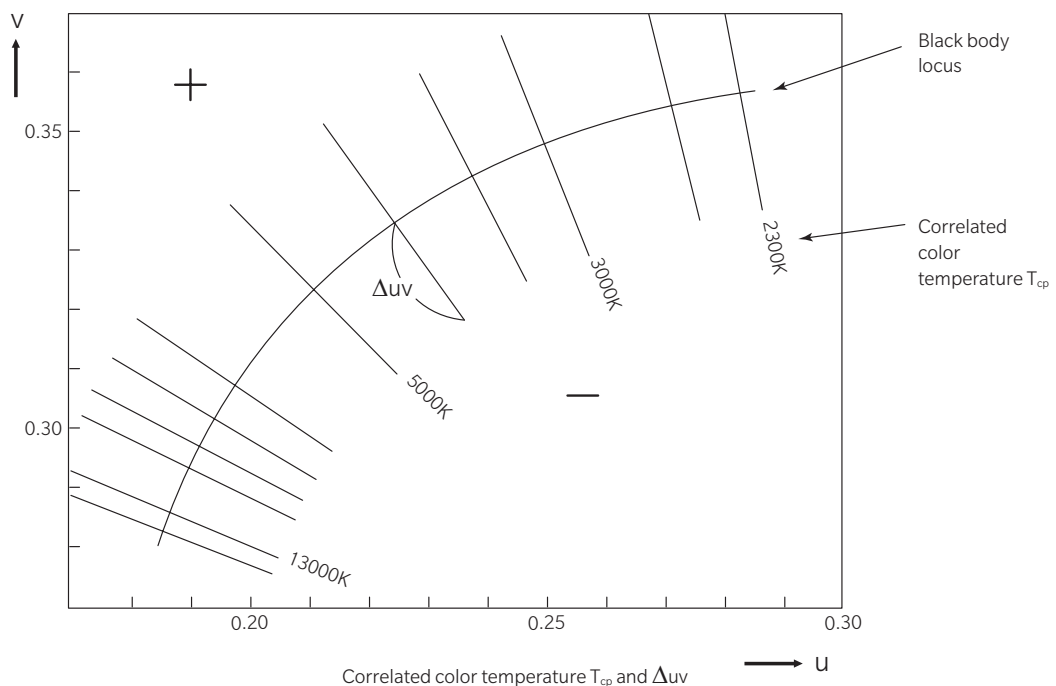

Explanation

# Dominant Wavelength/Excitation Purity

In the x, y chromaticity diagram shown below, the curve  $VS_cSR$  is the spectrum locus, and point N is the white point.

Colors located in the region enclosed by the spectrum locus and the straight lines VN and NR are referred to as spectral colors; colors located in the triangle NVR with the white point N at the apex and the pure-purple locus VR as the base are referred to as non-spectral colors.

## <Dominant wavelength and excitation purity (spectral colors)>

When the chromaticity point obtained by the measurement is C, the wavelength corresponding to the intersection point S of the extension of NC with the spectrum locus (curve  $VS_cSR$ ) is referred to as the dominant wavelength and indicated by the symbol  $\lambda_d$ .

The ratio of the lengths of the straight lines NC and NS is referred to as the excitation purity of color excitation C and indicated by the symbol  $p_e$ .

## <Complementary wavelength (non-spectral colors)>

When the chromaticity point obtained by measurement is  $C'$ , the extension of  $NC'$  toward  $C'$  does not intersect with the spectrum locus but only the pure-purple locus. In this case, the wavelength corresponding to the intersection point  $S_c$  of the extension of  $NC'$  toward N with the spectrum locus is referred to as the complementary wavelength and indicated by the symbol  $\lambda_c$ .

When the intersection point of the extension of the line  $NC'$  with the line VR (pure-purple locus) is designated by  $S'$ , the ratio of the lengths of  $NC'$  to  $NS'$  is referred to as excitation purity of color excitation  $C'$  and indicated by the symbol  $p'_v$ .

The following equations are formulated, if each point is designated as the following coordinates:

- $(x_n, y_n)$ : chromaticity coordinate of point N;
- $(x_c, y_c)$ : chromaticity coordinate of point C;
- $(x_\lambda, y_\lambda)$ : chromaticity coordinate of point S;
- $(x_{c'}, y_{c'})$ : chromaticity coordinate of point  $C'$ ;
- and  $(x_p, y_p)$ : chromaticity coordinate of point P:

Excitation purity (spectral colors)

$$p_e = \frac{x_c - x_n}{x_\lambda - x_n} = \frac{y_c - y_n}{y_\lambda - y_n}$$

Excitation purity (non-spectral colors)

$$p'_v = \frac{x_{c'} - x_n}{x_p - x_n} = \frac{y_{c'} - y_n}{y_p - y_n}$$

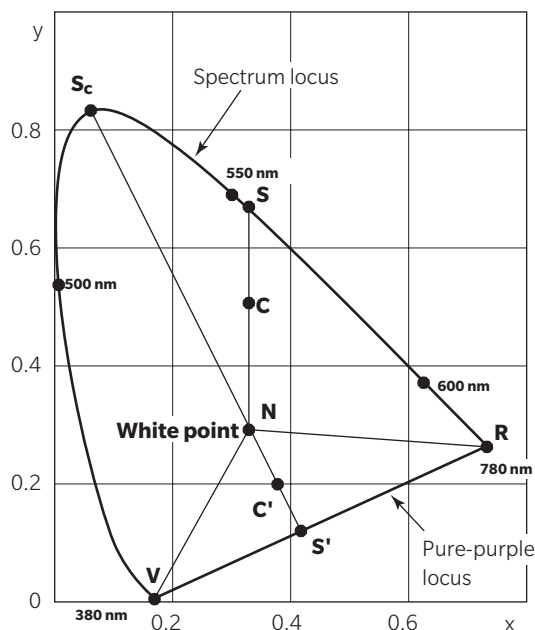

Dominant wavelength on chromaticity diagram

# Dimensions

● CS-3000HDR

(Unit: mm)

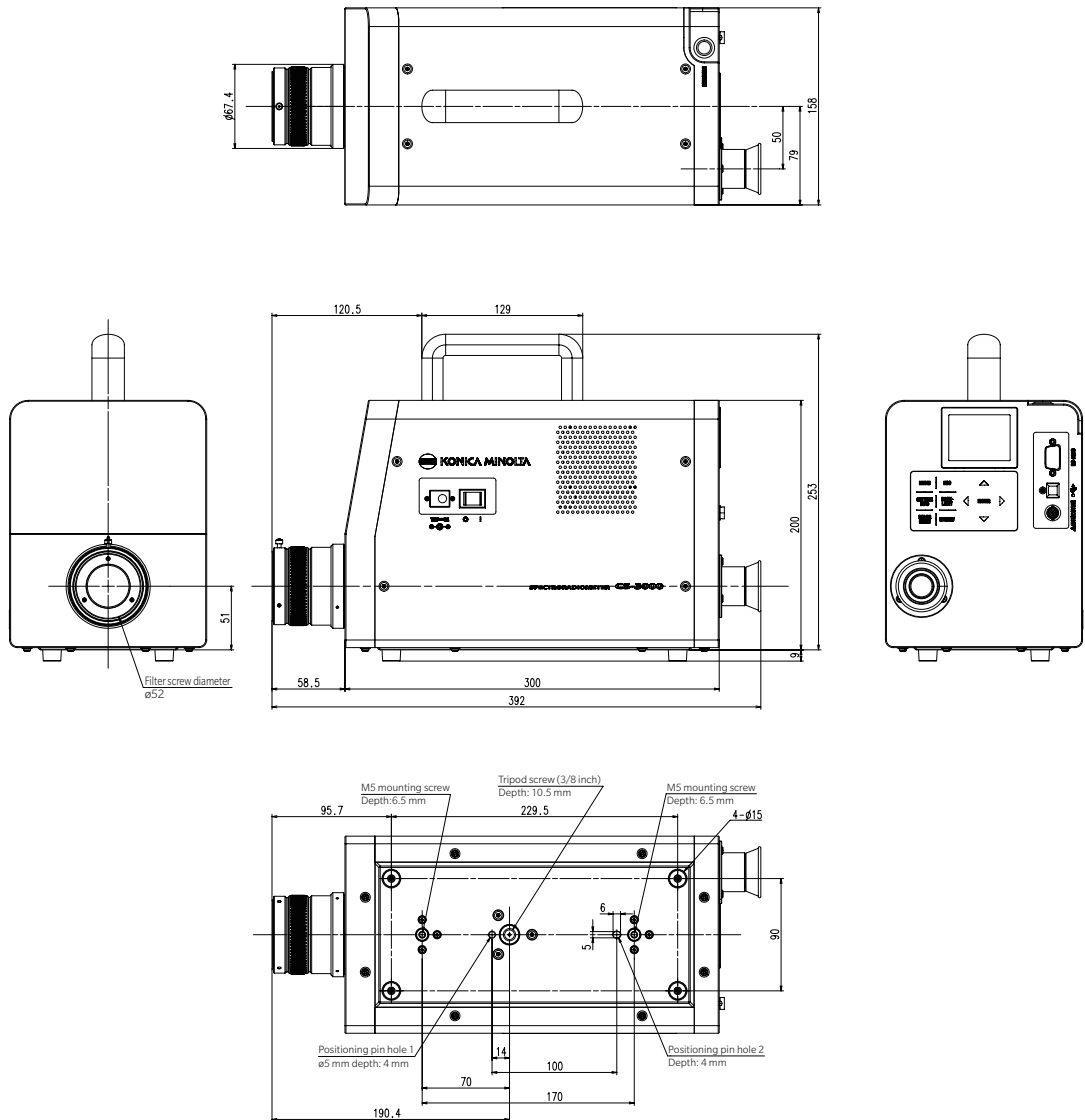

● CS-3000

(Unit: mm)

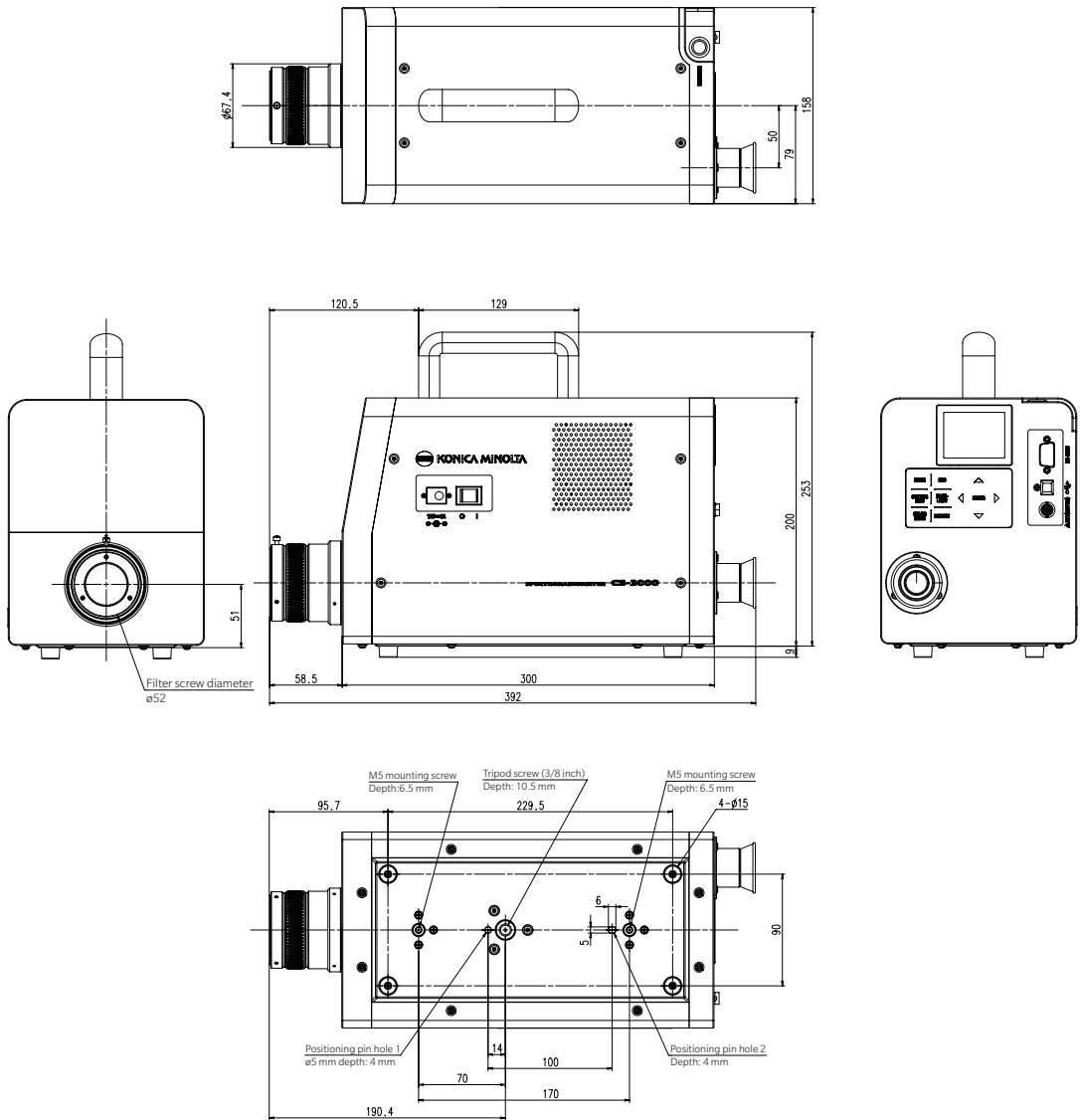

● CS-2000Plus

(Unit: mm)

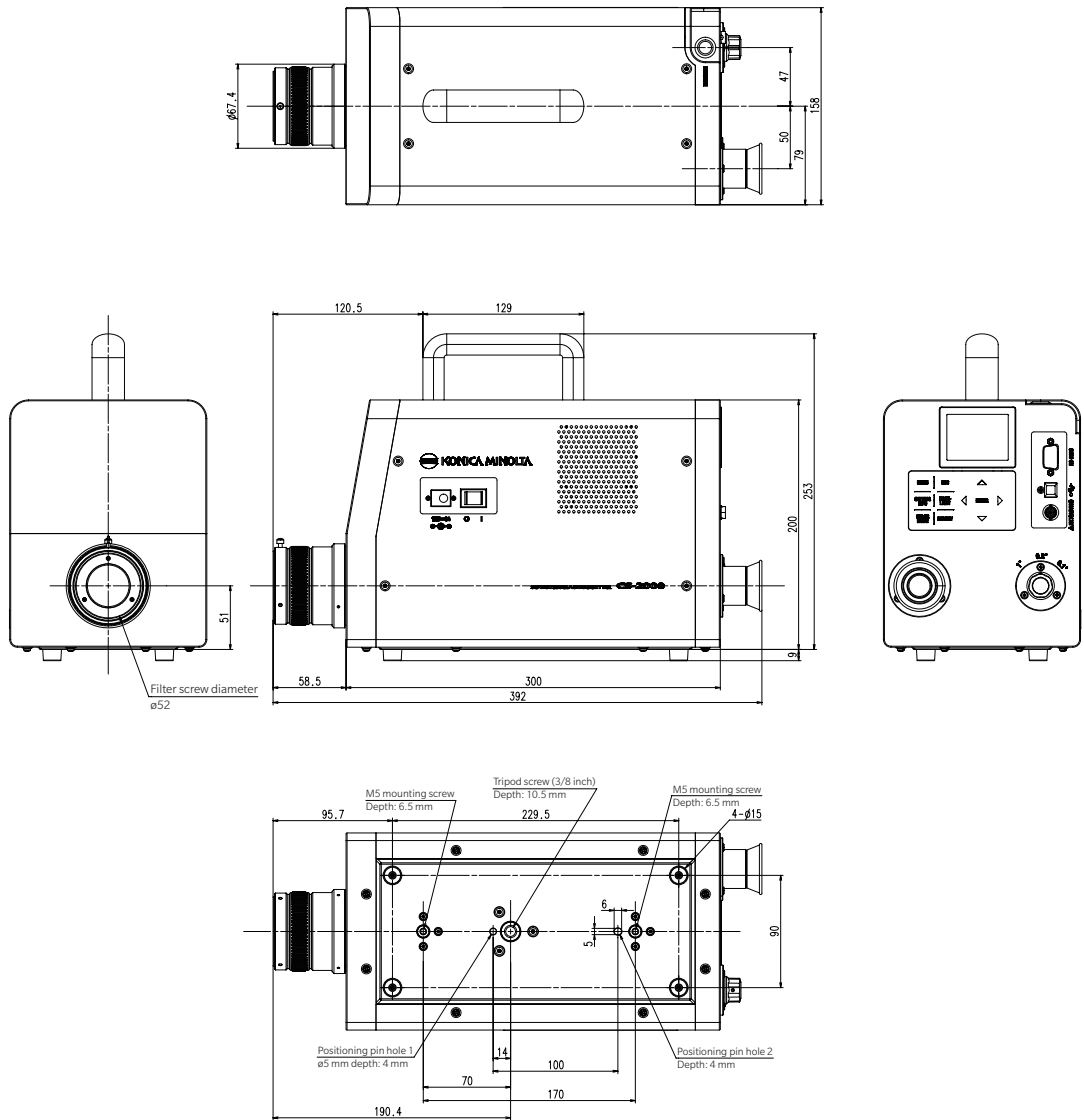

# Error Messages

Error messages appear on the LCD when this instrument does not operate normally. The table below shows the types of error message, causes (descriptions), and corrective actions respectively.

	Error message	Cause (details)	Corrective action
1	<b>OVER</b>	Luminance of measuring object is higher than the available range.  Flicker of measuring object is high.  The integration time is set short relative to the synchronization setting.	<ul style="list-style-type: none"> <li>• Use the ND filter and re-measure.</li> <li>• Decrease the measurement diameter and re-measure.</li> <li>• If the symptoms are not remedied, please contact the nearest KONICA MINOLTA-authorized service facility.</li> <li>• Set the flicker cycle in the INT SYNC mode, or input the flicker signal in the EXT SYNC mode.</li> <li>• Shorten synchronization time.</li> <li>• Set to asynchronous.</li> <li>• Set the measurement speed to slow mode.</li> </ul>
2	<b>SYNC ERROR</b>	Cannot detect input signal in the EXT SYNC mode.  Input signal in the EXT SYNC mode exceeds 200 Hz.  Input signal in the EXT SYNC mode is less than 0.5 Hz.	<ul style="list-style-type: none"> <li>• Input a vertically synchronized signal at a CMOS input level (0.8 / 1.2 / 1.8 / 3.3 / 5.0V).</li> <li>• Match the voltage setting of EXT VOLTAGE to the level of the vertically synchronized signal. If the level of the vertically synchronized signal is unknown, increase or decrease the voltage setting of EXT VOLTAGE and re-measure.</li> <li>• Set the input signal frequency value divided by an integer in the INT SYNC mode and re-measure.</li> <li>• Set the integral multiple value of the input signal frequency in the INT SYNC mode and re-measure using the MULTI INTEG-NORMAL mode or the MULTI INTEG-FAST mode.</li> <li>• Set the integral multiple value of the input signal cycle in the INT SYNC mode and re-measure in the MANUAL mode.</li> </ul>
3	<b>DETECTION ERROR</b>	The periodic light intensity fluctuations of the display were so small that the emission frequency could not be detected. Alternatively, the emission frequency is outside the detectable range.	<ul style="list-style-type: none"> <li>• Change the brightness of the display and retry frequency detection.</li> <li>• When measuring a display whose frequency cannot be detected and whose frequency is unknown, refer to the synchronization method setting (p.31) for the measurement.</li> </ul>
4	<b>MEASURING ANGLE SELECTOR ERROR</b>	Measurement was performed when the measuring angle selector was in the wrong position, or its position was changed during measurement.	<ul style="list-style-type: none"> <li>• Switch the measuring angle selector and re-measure.</li> <li>• If the symptoms are not remedied, please contact the nearest KONICA MINOLTA-authorized service facility.</li> </ul>
5	<b>TEMPERATURE ERROR</b>	The ambient temperature for the measurement device is too high, and the internal temperature of the sensor becomes abnormal. (If it occurs during continuous measurement, continuous measurement continues.)	<ul style="list-style-type: none"> <li>• Decrease the ambient temperature until the sensor reaches the specified temperature.</li> </ul>

	Error message	Cause (details)	Corrective action
6	<b>MEMORY ERROR</b>	There was an error in writing/reading data to/from memory.	<ul style="list-style-type: none"> <li>Switch off the power and turn it on again.</li> <li>If the symptoms are not remedied, please contact the nearest KONICA MINOLTA-authorized service facility.</li> </ul>
7	<b>NO DATA</b>	There is no registered data for the used calibration channels or accessories.	<ul style="list-style-type: none"> <li>Register the calibration coefficients in the calibration channel.</li> <li>Register the calibration coefficients of the accessories to be used.</li> </ul>
8	<b>Cannot be enabled when other attachment is enabled</b>	Tried to set up a combination of ND filters, closeup lenses, and illumination adapters.	<ul style="list-style-type: none"> <li>Only one of the ND filter, closeup lens, or illumination adapter should be attached. (Cannot be used in combination)</li> </ul>
9	<b>HARDWARE ERROR</b>	There is an abnormality in the mechanism, parts, or program of the instrument.	<ul style="list-style-type: none"> <li>Switch off the power and turn it on again.</li> <li>If the symptoms are not remedied, please contact the nearest KONICA MINOLTA-authorized service facility.</li> </ul>

## Caution Messages

When performing an operation, the instrument may display a caution message on the LCD and stop operation.

The table below shows the types of caution message, causes (descriptions), and corrective actions respectively.

	Caution message	Cause (details)	Corrective action
1	<b>Frequency not detected</b>	The periodic light intensity fluctuations of the display were so small that the emission frequency could not be detected. Alternatively, the emission frequency is outside the detectable range.	<ul style="list-style-type: none"> <li>Change the brightness of the display and retry frequency detection.</li> <li>When measuring a display whose frequency cannot be detected and whose frequency is unknown, refer to the synchronization method setting (p.31) for the measurement.</li> </ul>
2	<b>Warm-up not completed</b>	When performing the INTELLIGENT DARK measurement, the previous "dark measurement" was performed within 20 minutes of startup.	Performing a "dark measurement" is recommended. You can also choose to ignore the caution message. If you choose to ignore the caution message, the previous "dark measurement" value will be applied. For details on dark measurement (p.89), refer to .
3	<b>Long time after last DARK</b>	When performing the INTELLIGENT DARK measurement, more than 8 hours have elapsed since the last "dark measurement."	Same as above
4	<b>Temperature changed after last DARK</b>	When performing the INTELLIGENT DARK measurement, there is a difference of 6°C or more compared to the temperature at the last "dark measurement."	Same as above

# Error Check

Should any errors be found in the instrument, try the corrective actions shown in the following table. If this does not help, it is possible the instrument is broken. Please contact the nearest KONICA MINOLTA-authorized service facility with the error number and the version of your instrument. See p.90 for details about how to confirm the instrument version.

Error No.	Symptom	Item to check	Corrective action	Reference page
1	No display on the LCD after power is turned on.	Has the AC adapter been properly plugged into the AC outlet?	Connect the AC Adapter.	21
		Has the AC adapter been connected to this instrument?	Connect the AC Adapter.	21
		Has a wrong AC adapter been connected?	Be sure to use the AC adapter and power cord supplied as a standard or optional accessory (AC-A312G).	21
		Is AC power source within rated scale?	Use within $\pm 10\%$ of the nominal voltage.	21
2	Nothing is visible through the finder as the field of view is dark.	Is the lens cap still attached to the objective lens?	Remove the lens cap.	8
		Is the ND filter attached to the objective lens?	Use the ND filter when the luminance of the object being measured is too high.	9, 52
		Is the ND eyepiece filter attached to the finder?	Use the ND eyepiece filter when the luminance of the object being measured is too high.	9, 52
3	Nothing is displayed on the LCD.	Is the backlight set to OFF?	Press <b>BACKLIGHT</b> key to turn ON the backlight.	14, 56
		Has the backlight been set to OFF during measurement?	In the menu operation, set the backlight to ON during measurement.	56
4	Does not accept key operation.	Has the remote mode been set?	Press <b>ESC</b> key to cancel the remote mode.	85
		Have you pressed a disabled key?	Press the correct key.	—
5	Measurement is not possible even when the measurement button is pressed.	Is a screen other than MEAS displayed?	Perform measurement when the MEAS screen is displayed.	71
6	The entered value for target color is different from the one that will be displayed after setting.		A 1-digit difference may be found due to calculation error.	—
7	Measurement values do not appear.	Is there data?	Perform measurement when the MEAS screen is displayed.	70
		Has the color space mode become color temperature?	Color temperature is displayed as “___” if it is far from the black body locus. Display in a different color mode to confirm.	48
		Did you interrupt measurement?	Conduct measurement again.	70



Error No.	Symptom	Item to check	Corrective action	Reference page
8	Measurement values are inconsistent.	Is the measuring object stable?	Conduct measurement while the measuring object is stable.	—
		Is the measuring object of low luminance?	Repeatability of x, y worsens if the measuring object of low luminance is measured.	70, 26
			It especially worsens when the measurement angle is 0.2° or 0.1°.	
			It also worsens when the measurement time is short. Make the measurement time longer.	
		Is the measurement sync frequency appropriate when measuring the display?	Set the appropriate measurement sync frequency.	31, 28
			Use the MULTI INTEG-NORMAL mode or the MULTI INTEG-FAST mode.	
Measure in the EXT SYNC mode.				
Have the ambient temperature and /or humidity changed significantly?	Perform measurement under an environment free from changes in ambient temperature and humidity.	3		
Did you start measurement immediately after startup?	Allow the instrument to warm up for 20 minutes or more from when the power is switched on.	23		
9	Measurement values appear incorrectly.	Is the objective lens clean?	Should dirt get on the lens, wipe it off with a dry and soft cloth or lens cleaning paper.	5
		User calibration may not be performed correctly.	Check the values without user calibration (i.e. set the calibration channel to 00 (OFF)).	66
		Is the calibration channel correct?	Select the calibration channel according to the light source of luminance and chromaticity close to the object.	66
		Is the closeup lens attached?	Select the lens type setting according to the attached closeup lens.	50, 70
		Has the ND filter been attached?	Select the ND filter setting according to the attached ND filter.	52
		Has the object been focused?	Adjust the focus after adjusting the diopter.	13, 15, 71
10	The measurement stops halfway and does not finish in the set measurement time.	Is the measuring object of high luminance?	When measuring an object of high luminance, the sensor may be saturated by exceeding the upper limit of the current measurement setting.	52
			Use the ND filter.	

Error No.	Symptom	Item to check	Corrective action	Reference page
11	Actual measurement time is different from the displayed measurement time.		The displayed measurement time is the remaining time. The actual measurement time may be different from the displayed time depending on the mode setting of measurement time.	26
12	Measurement value on the LCD disappears.	Has the power source been supplied securely?	Connect to a stable power source and insert the AC adapter plug securely.	21
		Did you interrupt measurement?	When starting continuous measurement, press the measurement button securely. Do not press <b>ESC</b> key.	72
13	During USB communication: Cannot download data output from this instrument on the PC. Cannot enter commands or data from the PC to this instrument.	Has the USB cable been connected securely?	Connect this instrument and the PC securely.	82
		Has the USB cable been disconnected?	Replace the USB cable.	—
		Has the remote mode been canceled?	Send the connection command from the PC to this instrument and switch to the remote mode. Use the CS-S30 software for spectroradiometers included in the standard accessories.	85
		Has the program been prepared correctly?	Refer to communication specifications and check the program. Use the CS-S30 software for spectroradiometers included in the standard accessories.	—
		Is RS communication being used?	Simultaneous use of RS communication and USB communication is not possible. Press <b>ESC</b> key to exit the remote mode, and then restart communication via USB only.	—
14	An instrument malfunction has occurred (including errors 1 through 13).	Has the RS-232C connector been touched? Is the cap attached?	Turn the instrument off and back on to restart. Accidentally touching the RS-232C connector can cause malfunction due to static electricity, so be sure to attach the cap.	82
15	Data output by the instrument during RS communication cannot be imported to the PC. Cannot enter commands or data from the PC to this instrument.	Has the RS cable been connected securely?	Connect this instrument and the PC securely.	83
		Has the RS cable been disconnected?	Replace the RS cable.	—
		Has the remote mode been canceled?	Send the connection command from the PC to this instrument and switch to the remote mode.	—
		Has the program been prepared correctly?	Refer to communication specifications and check the program.	—
		Is USB communication being used?	Simultaneous use of RS communication and USB communication is not possible. Press <b>ESC</b> key to exit the remote mode, and then restart communication via RS only.	—
16	The same error message appears repeatedly.	Check the appropriate corrective action for the error message.	If the symptoms are not remedied, please contact the nearest KONICA MINOLTA-authorized service facility.	—

# Setting Initialization

The set measurement conditions can be initialized to the factory default settings by following the procedure below.

\* Factory default setting:

* Synchronization method	: INT SYNC 59.94 Hz	* Measurement speed	: NORMAL
* Color matching function	: CIE1931 (2°)		IN-ND: AUTO
* Color space mode	: L <sub>a</sub> xy	* Display Format	: ***** [F]
* Accessories (ACC)	: NONE		
* Backlight during measurement	: ON		
* RS-232C communication	: 115200bps		
	baud rate		

## Operating Procedure

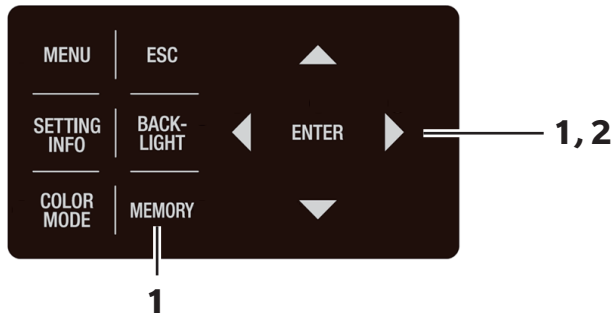

- 1. When the power switch is OFF (O), turn it to ON (|) while pressing the **MEMORY** key, **▲** key and **▼** key simultaneously.**

The **INITIALIZE SETTINGS (for confirming setting initialization)** screen appears approx. 5 seconds after the initial screen is displayed on the LCD.

Continue pressing **MEMORY** key, **▲** key and **▼** key until the **INITIALIZE SETTINGS** screen appears.



- 2. Press **◀** key to select [OK], and then press **ENTER** key.**

The various measurement conditions that have been set are initialized, and the **MEAS** screen appears on the LCD.

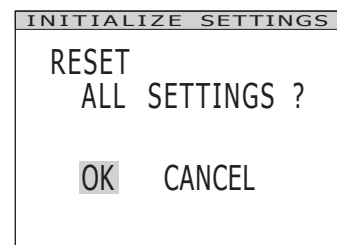

# Main Specifications

Model	CS-3000HDR SPECTRORADIOMETER		
Measurement wavelength range	380 to 780 nm		
Wavelength resolution	0.9 nm/pixel		
Display wavelength interval	1.0 nm		
Wavelength precision	±0.3 nm (center-of-gravity wavelength mercury cadmium lamp: 435.8 nm, 546.1 nm, 643.8 nm)		
Spectrum wavelength width	5 nm max. (half width value)		
Measurement angle (electrically switchable)	1°	0.2°	0.1°
Luminance range with guaranteed accuracy (Light source A)	0.0001 to 100,000 cd/m <sup>2</sup>	0.0025 to 2,500,000 cd/m <sup>2</sup>	0.01 to 10,000,000 cd/m <sup>2</sup>
Minimum measurement diameter	ø5 mm (ø1 mm when using closeup lens)	ø1 mm (ø0.2 mm when using closeup lens)	ø0.5 mm (ø0.1 mm when using closeup lens)
Minimum objective distance	350 mm (55 mm when using closeup lens)		
Minimum luminance display	0.00002 cd/m <sup>2</sup>		
Minimum spectral radiance display	1.0 × 10 <sup>-9</sup> W/(sr·m <sup>2</sup> ·nm)		
Luminance: Accuracy <sup>1</sup> (Light source A)	± 5 % (0.0001 to 0.0004 cd/m <sup>2</sup> ) ± 2 % (0.0004 to 10,000,000 cd/m <sup>2</sup> )		
Luminance: Repeatability (2σ) <sup>2</sup> (Light source A)	5% (0.0001 to 0.004 cd/m <sup>2</sup> ) 1.5% (0.0004 to 0.001 cd/m <sup>2</sup> ) 0.7% (0.001 to 0.003 cd/m <sup>2</sup> ) 0.25% (0.003 to 0.05 cd/m <sup>2</sup> ) 0.15% (0.05 to 100,000 cd/m <sup>2</sup> )	5% (0.0025 to 0.01 cd/m <sup>2</sup> ) 1.5% (0.01 to 0.025 cd/m <sup>2</sup> ) 0.7% (0.025 to 0.075 cd/m <sup>2</sup> ) 0.25% (0.075 to 1.25 cd/m <sup>2</sup> ) 0.15% (1.25 to 2,500,000 cd/m <sup>2</sup> )	5% (0.01 to 0.04 cd/m <sup>2</sup> ) 1.5% (0.04 to 0.1 cd/m <sup>2</sup> ) 0.7% (0.1 to 0.3 cd/m <sup>2</sup> ) 0.25% (0.3 to 5 cd/m <sup>2</sup> ) 0.15% (5 to 10,000,000 cd/m <sup>2</sup> )
Chromaticity: Accuracy <sup>1</sup> (Light source A)	x: ±0.002, y: ±0.002 (0.001 to 0.05 cd/m <sup>2</sup> ) x: ±0.0015, y: ±0.001 (0.05 to 100,000 cd/m <sup>2</sup> ) u': ±0.0014, v': ±0.0011 (0.001 to 0.05 cd/m <sup>2</sup> ) u': ±0.0014, v': ±0.0006 (0.05 to 100,000 cd/m <sup>2</sup> )	x: ±0.002, y: ±0.002 (0.025 to 1.25 cd/m <sup>2</sup> ) x: ±0.0015, y: ±0.001 (1.25 to 2,500,000 cd/m <sup>2</sup> ) u': ±0.0022, v': ±0.0011 (0.025 to 1.25 cd/m <sup>2</sup> ) u': ±0.0014, v': ±0.0006 (1.25 to 2,500,000 cd/m <sup>2</sup> )	x: ±0.002, y: ±0.002 (0.1 to 5 cd/m <sup>2</sup> ) x: ±0.0015, y: ±0.001 (5 to 10,000,000 cd/m <sup>2</sup> ) u': ±0.0022, v': ±0.0011 (0.1 to 5 cd/m <sup>2</sup> ) u': ±0.0014, v': ±0.0006 (5 to 10,000,000 cd/m <sup>2</sup> )
Chromaticity: Repeatability (2σ) <sup>2</sup> (Light source A)	x: 0.0030, y: 0.0035 (0.001 to 0.003 cd/m <sup>2</sup> ) x: 0.0010, y: 0.0015 (0.003 to 0.1 cd/m <sup>2</sup> ) x: 0.0006, y: 0.0006 (0.1 to 0.2 cd/m <sup>2</sup> ) x: 0.0004, y: 0.0004 (0.2 to 100,000 cd/m <sup>2</sup> ) u': 0.0024, v': 0.0014 (0.001 to 0.003 cd/m <sup>2</sup> ) u': 0.0009, v': 0.0006 (0.003 to 0.1 cd/m <sup>2</sup> ) u': 0.0005, v': 0.0002 (0.1 to 0.2 cd/m <sup>2</sup> ) u': 0.0003, v': 0.0002 (0.2 to 100,000 cd/m <sup>2</sup> )	x: 0.0030, y: 0.0035 (0.025 to 0.075 cd/m <sup>2</sup> ) x: 0.0010, y: 0.0015 (0.075 to 2.5 cd/m <sup>2</sup> ) x: 0.0006, y: 0.0006 (2.5 to 5 cd/m <sup>2</sup> ) x: 0.0004, y: 0.0004 (5 to 2,500,000 cd/m <sup>2</sup> ) u': 0.0024, v': 0.0014 (0.025 to 0.075 cd/m <sup>2</sup> ) u': 0.0009, v': 0.0006 (0.075 to 2.5 cd/m <sup>2</sup> ) u': 0.0005, v': 0.0002 (2.5 to 5 cd/m <sup>2</sup> ) u': 0.0003, v': 0.0002 (5 to 2,500,000 cd/m <sup>2</sup> )	x: 0.0030, y: 0.0035 (0.1 to 0.3 cd/m <sup>2</sup> ) x: 0.0010, y: 0.0015 (0.3 to 10 cd/m <sup>2</sup> ) x: 0.0006, y: 0.0006 (10 to 20 cd/m <sup>2</sup> ) x: 0.0004, y: 0.0004 (20 to 10,000,000 cd/m <sup>2</sup> ) u': 0.0024, v': 0.0014 (0.1 to 0.3 cd/m <sup>2</sup> ) u': 0.0009, v': 0.0006 (0.3 to 10 cd/m <sup>2</sup> ) u': 0.0005, v': 0.0002 (10 to 20 cd/m <sup>2</sup> ) u': 0.0003, v': 0.0002 (20 to 10,000,000 cd/m <sup>2</sup> )
Polarization error	2% or less (400 to 780 nm): 1° and 3% or less (400 to 780 nm): 0.2° and 0.1°		
Integration time	0.005 to 92 seconds (NORMAL mode); 0.005 to 16 seconds (FAST mode)		
Measurement time	Standalone	Minimum of 1 second or less (MANUAL mode) to approx. 190 seconds (NORMAL mode) or maximum of approx. 242 seconds (MANUAL mode)	
	Communication <sup>3</sup>	Approx. 0.07 seconds (when MANUAL mode, 33.333 ms and INTELLIGENT DARK function are set)	
Color space mode	L <sub>x</sub> , y, L <sub>y</sub> , u', v', L <sub>v</sub> , TΔuv, XYZ, spectrograph, main wavelength, excitation purity		
Color matching functions	CIE1931 (2°), CIE1964 (10°), CIE170-2:2015 (PA2°, PA10°), any isochromatic function (measurement software supported)		
Optical frequency detection function	Detectable range: Luminance of 10 to 5,000 cd/m <sup>2</sup> and emission frequency of 10 to 200 Hz. Detection accuracy: ±0.015 Hz; Detection time: Approx. 3 seconds		
Interfaces	USB 2.0, RS-232C		
Operating temperature and humidity range	5 to 30°C, 80% RH max. (no condensation)		
Storage temperature and humidity range	0 to 35°C, 80% RH max. (no condensation)		
Power	Dedicated AC adapter (100 to 240 V $\sim$ , 50/60 Hz)		
Power consumption	Approx. 20 W		
Size	158 (W) × 262 (H) × 392 (D) mm		
Weight	Approx. 7.0 kg		

\*1: Average value of 10 measurements in the NORMAL mode, at temperature of 23°C ± 2°C and maximum relative humidity of 65%.

\*2: Average value of 10 measurements in the NORMAL mode, at temperature of 23°C ± 2°C and maximum relative humidity of 65%.

\*3: When the USB cable is connected. Excluding the time required for display and shutter opening/closing. In an environment designated by KONICA MINOLTA such as a PC.

Model		CS-3000 SPECTRORADIOMETER		
Measurement wavelength range	380 to 780 nm			
Wavelength resolution	0.9 nm/pixel			
Display wavelength interval	1.0 nm			
Wavelength precision	±0.3 nm (center-of-gravity wavelength mercury cadmium lamp: 435.8 nm, 546.1 nm, 643.8 nm)			
Spectrum wavelength width	5 nm max. (half width value)			
Measurement angle (electrically switchable)	1°	0.2°	0.1°	
Luminance range with guaranteed accuracy (Light source A)	0.0005 to 5,000 cd/m <sup>2</sup>	0.0125 to 125,000 cd/m <sup>2</sup>	0.05 to 500,000 cd/m <sup>2</sup>	
Minimum measurement diameter	ø5 mm (ø1 mm when using closeup lens)	ø1 mm (ø0.2 mm when using closeup lens)	ø0.5 mm (ø0.1 mm when using closeup lens)	
Minimum objective distance	350 mm (55 mm when using closeup lens)			
Minimum luminance display	0.00002 cd/m <sup>2</sup>			
Minimum spectral radiance display	1.0 × 10 <sup>-9</sup> W/(sr·m <sup>2</sup> ·nm)			
Luminance: Accuracy <sup>*1</sup> (Light source A)	±2%			
Luminance: Repeatability (2σ) <sup>*2</sup> (Light source A)	1.5% (0.0005 to 0.001 cd/m <sup>2</sup> ) 0.7% (0.001 to 0.003 cd/m <sup>2</sup> ) 0.25% (0.003 to 0.05 cd/m <sup>2</sup> ) 0.15% (0.05 to 5,000 cd/m <sup>2</sup> )	1.5% (0.0125 to 0.025 cd/m <sup>2</sup> ) 0.7% (0.025 to 0.075 cd/m <sup>2</sup> ) 0.25% (0.075 to 1.25 cd/m <sup>2</sup> ) 0.15% (1.25 to 125,000 cd/m <sup>2</sup> )	1.5% (0.05 to 0.1 cd/m <sup>2</sup> ) 0.7% (0.1 to 0.3 cd/m <sup>2</sup> ) 0.25% (0.3 to 5 cd/m <sup>2</sup> ) 0.15% (5 to 500,000 cd/m <sup>2</sup> )	
Chromaticity: Accuracy <sup>*1</sup> (Light source A)	x: ±0.002, y: ±0.002 (0.001 to 0.05 cd/m <sup>2</sup> ) x: ±0.0015, y: ±0.001 (0.05 to 5,000 cd/m <sup>2</sup> ) u': ±0.0022, v': ±0.0011 (0.001 to 0.05 cd/m <sup>2</sup> ) u': ±0.0014, v': ±0.0006 (0.05 to 5,000 cd/m <sup>2</sup> )	x: ±0.002, y: ±0.002 (0.025 to 1.25 cd/m <sup>2</sup> ) x: ±0.0015, y: ±0.001 (1.25 to 125,000 cd/m <sup>2</sup> ) u': ±0.0022, v': ±0.0011 (0.025 to 1.25 cd/m <sup>2</sup> ) u': ±0.0014, v': ±0.0006 (1.25 to 125,000 cd/m <sup>2</sup> )	x: ±0.002, y: ±0.002 (0.1 to 5 cd/m <sup>2</sup> ) x: ±0.0015, y: ±0.001 (5 to 500,000 cd/m <sup>2</sup> ) u': ±0.0022, v': ±0.0011 (0.1 to 5 cd/m <sup>2</sup> ) u': ±0.0014, v': ±0.0006 (5 to 500,000 cd/m <sup>2</sup> )	
Chromaticity: Repeatability (2σ) <sup>*2</sup> (Light source A)	x: 0.0030, y: 0.0035 (0.001 to 0.003 cd/m <sup>2</sup> ) x: 0.0010, y: 0.0015 (0.003 to 0.1 cd/m <sup>2</sup> ) x: 0.0006, y: 0.0006 (0.1 to 0.2 cd/m <sup>2</sup> ) x: 0.0004, y: 0.0004 (0.2 to 5,000 cd/m <sup>2</sup> ) u': 0.0024, v': 0.0014 (0.001 to 0.003 cd/m <sup>2</sup> ) u': 0.0009, v': 0.0006 (0.003 to 0.1 cd/m <sup>2</sup> ) u': 0.0005, v': 0.0002 (0.1 to 0.2 cd/m <sup>2</sup> ) u': 0.0003, v': 0.0002 (0.2 to 5,000 cd/m <sup>2</sup> )	x: 0.0030, y: 0.0035 (0.025 to 0.075 cd/m <sup>2</sup> ) x: 0.0010, y: 0.0015 (0.075 to 2.5 cd/m <sup>2</sup> ) x: 0.0006, y: 0.0006 (2.5 to 5 cd/m <sup>2</sup> ) x: 0.0004, y: 0.0004 (5 to 125,000 cd/m <sup>2</sup> ) u': 0.0024, v': 0.0014 (0.025 to 0.075 cd/m <sup>2</sup> ) u': 0.0009, v': 0.0006 (0.075 to 2.5 cd/m <sup>2</sup> ) u': 0.0005, v': 0.0002 (2.5 to 5 cd/m <sup>2</sup> ) u': 0.0003, v': 0.0002 (5 to 125,000 cd/m <sup>2</sup> )	x: 0.0030, y: 0.0035 (0.1 to 0.3 cd/m <sup>2</sup> ) x: 0.0010, y: 0.0015 (0.3 to 10 cd/m <sup>2</sup> ) x: 0.0006, y: 0.0006 (10 to 20 cd/m <sup>2</sup> ) x: 0.0004, y: 0.0004 (20 to 500,000 cd/m <sup>2</sup> ) u': 0.0024, v': 0.0014 (0.1 to 0.3 cd/m <sup>2</sup> ) u': 0.0009, v': 0.0006 (0.3 to 10 cd/m <sup>2</sup> ) u': 0.0005, v': 0.0002 (10 to 20 cd/m <sup>2</sup> ) u': 0.0003, v': 0.0002 (20 to 500,000 cd/m <sup>2</sup> )	
Polarization error	2% or less (400 to 780 nm): 1° and 3% or less (400 to 780 nm): 0.2° and 0.1°			
Integration time	0.005 to 92 seconds (NORMAL mode); 0.005 to 16 seconds (FAST mode)			
Measurement time	Standalone	Minimum of 1 second or less (MANUAL mode) to approx. 190 seconds (NORMAL mode) or maximum of approx. 242 seconds (MANUAL mode)		
	Communication <sup>*3</sup>	Approx. 0.07 seconds (when MANUAL mode, 33.333 ms and INTELLIGENT DARK function are set)		
Color space mode	L <sub>s</sub> , x <sub>y</sub> , L <sub>s</sub> , u' v', L <sub>s</sub> , TΔuv, XYZ, spectrograph, main wavelength, excitation purity			
Color matching functions	CIE1931 (2°), CIE1964 (10°), CIE170-2:2015 (PA2°, PA10°), any isochromatic function (measurement software supported)			
Optical frequency detection function	Detectable range: Luminance of 10 to 5,000 cd/m <sup>2</sup> and emission frequency of 10 to 200 Hz. Detection accuracy: ±0.015 Hz; Detection time: Approx. 3 seconds			
Interfaces	USB 2.0, RS-232C			
Operating temperature and humidity range	5 to 30°C, 80% RH max. (no condensation)			
Storage temperature and humidity range	0 to 35°C, 80% RH max. (no condensation)			
Power	Dedicated AC adapter (100 to 240 V $\sim$ , 50/60 Hz)			
Power consumption	Approx. 20 W			
Size	158 (W) × 262 (H) × 392 (D) mm			
Weight	Approx. 7.0 kg			

\*1: Average value of 10 measurements in the NORMAL mode, at temperature of 23°C ± 2°C and maximum relative humidity of 65%.

\*2: Average value of 10 measurements in the NORMAL mode, at temperature of 23°C ± 2°C and maximum relative humidity of 65%.

\*3: When the USB cable is connected. Excluding the time required for display and shutter opening/closing. In an environment designated by KONICA MINOLTA such as a PC.

Model		CS-2000Plus SPECTRORADIOMETER		
Measurement wavelength range	380 to 780 nm			
Wavelength resolution	0.9 nm/pixel			
Display wavelength interval	1.0 nm			
Wavelength precision	±0.3 nm (center-of-gravity wavelength mercury cadmium lamp: 435.8 nm, 546.1 nm, 643.8 nm)			
Spectrum wavelength width	5 nm max. (half width value)			
Measurement angle (manually switchable)	1°	0.2°	0.1°	
Luminance range with guaranteed accuracy (Light source A)	0.003 to 5,000 cd/m <sup>2</sup>	0.075 to 125,000 cd/m <sup>2</sup>	0.3 to 500,000 cd/m <sup>2</sup>	
Minimum measurement diameter	ø5 mm (ø1 mm when using closeup lens)	ø1 mm (ø0.2 mm when using closeup lens)	ø0.5 mm (ø0.1 mm when using closeup lens)	
Minimum objective distance	350 mm (55 mm when using closeup lens)			
Minimum luminance display	0.00002 cd/m <sup>2</sup>			
Minimum spectral radiance display	1.0 × 10 <sup>-9</sup> W/(sr·m <sup>2</sup> ·nm)			
Luminance: Accuracy <sup>*1</sup> (Light source A)	±2%			
Luminance: Repeatability (2σ) <sup>*2</sup> (Light source A)	0.4% (0.003 to 0.05 cd/m <sup>2</sup> ) 0.3% (0.05 to 0.1 cd/m <sup>2</sup> ) 0.15% (0.1 to 5,000 cd/m <sup>2</sup> )	0.4% (0.075 to 1.25 cd/m <sup>2</sup> ) 0.3% (1.25 to 2.5 cd/m <sup>2</sup> ) 0.15% (2.5 to 125,000 cd/m <sup>2</sup> )	0.4% (0.3 to 5 cd/m <sup>2</sup> ) 0.3% (5 to 10 cd/m <sup>2</sup> ) 0.15% (10 to 500,000 cd/m <sup>2</sup> )	
Chromaticity: Accuracy <sup>*1</sup> (Light source A)	x: ±0.003, y: ±0.003 (0.003 to 0.005 cd/m <sup>2</sup> ) x: ±0.002, y: ±0.002 (0.005 to 0.05 cd/m <sup>2</sup> ) x: ±0.0015, y: ±0.001 (0.05 to 5,000 cd/m <sup>2</sup> ) u': ±0.0033, v': ±0.0016 (0.003 to 0.005 cd/m <sup>2</sup> ) u': ±0.0022, v': ±0.0011 (0.005 to 0.05 cd/m <sup>2</sup> ) u': ±0.0014, v': ±0.0006 (0.05 to 5,000 cd/m <sup>2</sup> )	x: ±0.003, y: ±0.003 (0.075 to 0.125 cd/m <sup>2</sup> ) x: ±0.002, y: ±0.002 (0.125 to 1.25 cd/m <sup>2</sup> ) x: ±0.0015, y: ±0.001 (1.25 to 125,000 cd/m <sup>2</sup> ) u': ±0.0033, v': ±0.0016 (0.075 to 0.125 cd/m <sup>2</sup> ) u': ±0.0022, v': ±0.0011 (0.125 to 1.25 cd/m <sup>2</sup> ) u': ±0.0014, v': ±0.0006 (1.25 to 125,000 cd/m <sup>2</sup> )	x: ±0.003, y: ±0.003 (0.3 to 0.5 cd/m <sup>2</sup> ) x: ±0.002, y: ±0.002 (0.5 to 5 cd/m <sup>2</sup> ) x: ±0.0015, y: ±0.001 (5 to 500,000 cd/m <sup>2</sup> ) u': ±0.0033, v': ±0.0016 (0.3 to 0.5 cd/m <sup>2</sup> ) u': ±0.0022, v': ±0.0011 (0.5 to 5 cd/m <sup>2</sup> ) u': ±0.0014, v': ±0.0006 (5 to 500,000 cd/m <sup>2</sup> )	
Chromaticity: Repeatability (2σ) <sup>*2</sup> (Light source A)	x: 0.002, y: 0.002 (0.003 to 0.005 cd/m <sup>2</sup> ) x: 0.001, y: 0.001 (0.005 to 0.1 cd/m <sup>2</sup> ) x: 0.0006, y: 0.0006 (0.1 to 0.2 cd/m <sup>2</sup> ) x: 0.0004, y: 0.0004 (0.2 to 5,000 cd/m <sup>2</sup> ) u': 0.0016, v': 0.0008 (0.003 to 0.005 cd/m <sup>2</sup> ) u': 0.0008, v': 0.0004 (0.005 to 0.1 cd/m <sup>2</sup> ) u': 0.0005, v': 0.0002 (0.1 to 0.2 cd/m <sup>2</sup> ) u': 0.0003, v': 0.0002 (0.2 to 5,000 cd/m <sup>2</sup> )	x: 0.002, y: 0.002 (0.075 to 0.125 cd/m <sup>2</sup> ) x: 0.001, y: 0.001 (0.125 to 2.5 cd/m <sup>2</sup> ) x: 0.0006, y: 0.0006 (2.5 to 5 cd/m <sup>2</sup> ) x: 0.0004, y: 0.0004 (5 to 125,000 cd/m <sup>2</sup> ) u': 0.0016, v': 0.0008 (0.075 to 0.125 cd/m <sup>2</sup> ) u': 0.0008, v': 0.0004 (0.125 to 2.5 cd/m <sup>2</sup> ) u': 0.0005, v': 0.0002 (2.5 to 5 cd/m <sup>2</sup> ) u': 0.0003, v': 0.0002 (5 to 125,000 cd/m <sup>2</sup> )	x: 0.002, y: 0.002 (0.3 to 0.5 cd/m <sup>2</sup> ) x: 0.001, y: 0.001 (0.5 to 10 cd/m <sup>2</sup> ) x: 0.0006, y: 0.0006 (10 to 20 cd/m <sup>2</sup> ) x: 0.0004, y: 0.0004 (20 to 500,000 cd/m <sup>2</sup> ) u': 0.0016, v': 0.0008 (0.3 to 0.5 cd/m <sup>2</sup> ) u': 0.0008, v': 0.0004 (0.5 to 10 cd/m <sup>2</sup> ) u': 0.0005, v': 0.0002 (10 to 20 cd/m <sup>2</sup> ) u': 0.0003, v': 0.0002 (20 to 500,000 cd/m <sup>2</sup> )	
Polarization error	2% or less (400 to 780 nm): 1° and 3% or less (400 to 780 nm): 0.2° and 0.1°			
Integration time	0.005 to 120 seconds (NORMAL mode); 0.005 to 16 seconds (FAST mode)			
Measurement time	Standalone	Minimum of 1 second or less (MANUAL mode) to approx. 242 seconds (NORMAL mode)		
	Communication <sup>*3</sup>	Approx. 0.08 seconds (when MANUAL mode, 33.333 ms and INTELLIGENT DARK function are set)		
Color space mode	L <sub>v</sub> , x <sub>y</sub> , L <sub>v</sub> , u'v', L <sub>v</sub> , TΔuv, XYZ, spectrograph, main wavelength, excitation purity			
Color matching functions	CIE1931 (2°), CIE1964 (10°), CIE170-2:2015 (PA2°, PA10°), any isochromatic function (measurement software supported)			
Optical frequency detection function	None			
Interfaces	USB 2.0; RS-232C			
Operating temperature and humidity range	5 to 35°C, 80% RH max. (no condensation)			
Storage temperature and humidity range	0 to 35°C, 80% RH max. (no condensation)			
Power	Dedicated AC adapter (100 to 240 V~, 50/60 Hz)			
Power consumption	Approx. 20 W			
Size	158 (W) × 262 (H) × 392 (D) mm			
Weight	Approx. 7.0 kg			

\*1: Average value of 10 measurements in the NORMAL mode, at temperature of 23°C ± 2°C and maximum relative humidity of 65%.

\*2: Average value of 10 measurements in the NORMAL mode, at temperature of 23°C ± 2°C and maximum relative humidity of 65%.

\*3: When the USB cable is connected. Excluding the time required for display and shutter opening/closing. In an environment designated by KONICA MINOLTA such as a PC.

**< CAUTION >**

- **KONICA MINOLTA WILL NOT BE LIABLE FOR ANY DAMAGES RESULTING FROM THE MISUSE, MISHANDLING, UNAUTHORIZED MODIFICATION, ETC. OF THIS PRODUCT, OR FOR ANY INDIRECT OR INCIDENTAL DAMAGES (INCLUDING BUT NOT LIMITED TO LOSS OF BUSINESS PROFITS, INTERRUPTION OF BUSINESS, ETC.) DUE TO THE USE OF OR INABILITY TO USE THIS PRODUCT.**



KONICA MINOLTA